

# ASSEMBLY INSTRUCTIONS



5 min



2 pers

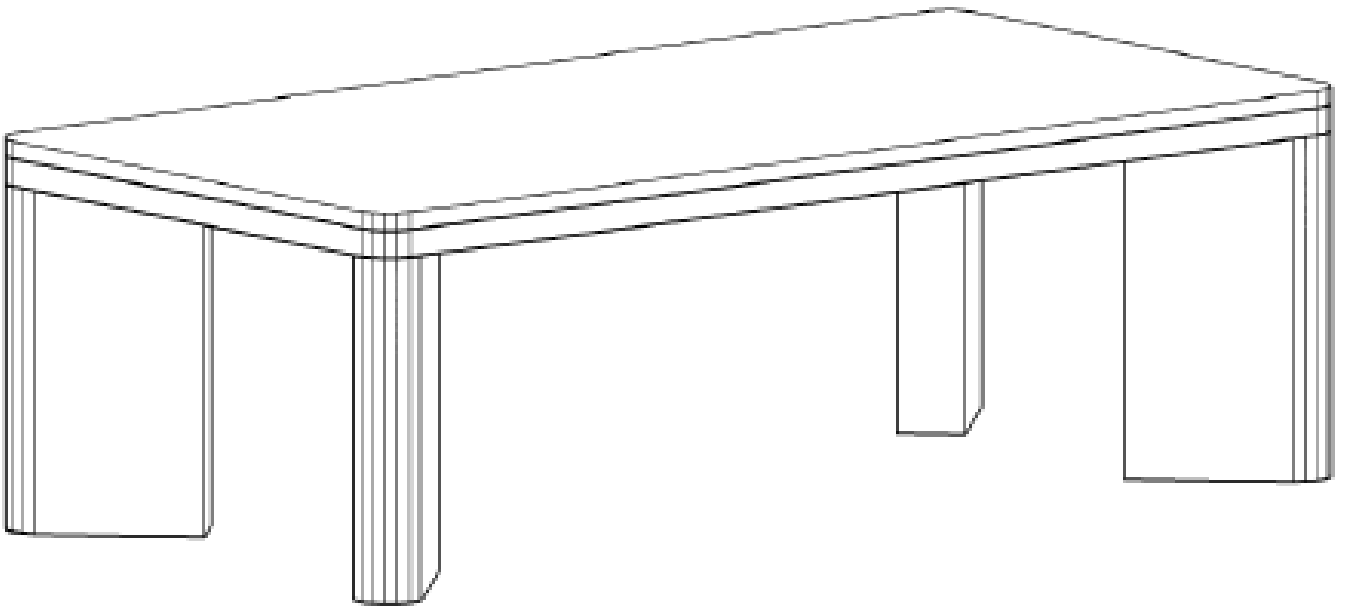

A

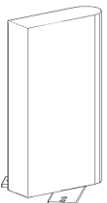

**Bx4**



**Cx1**

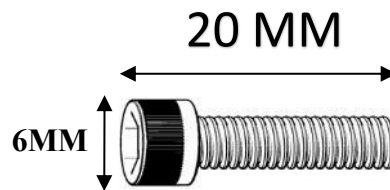

**Dx8**

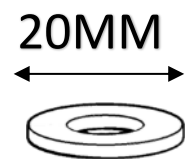

**Ex8**

1

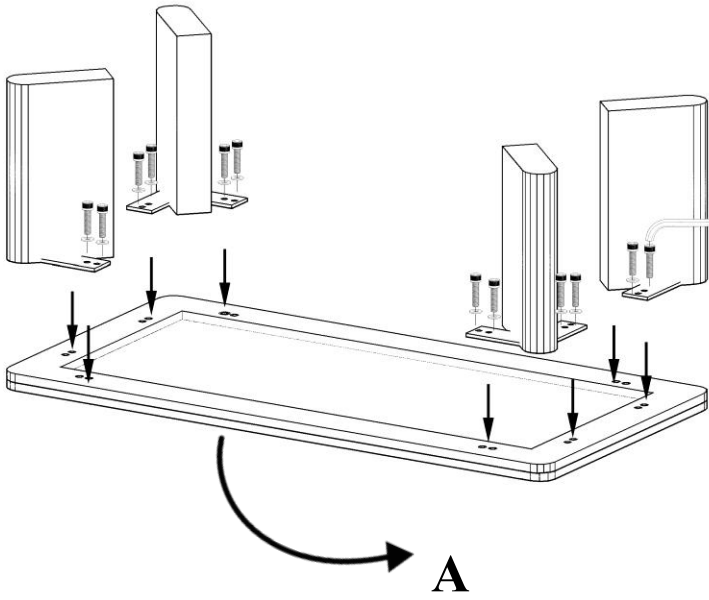

2

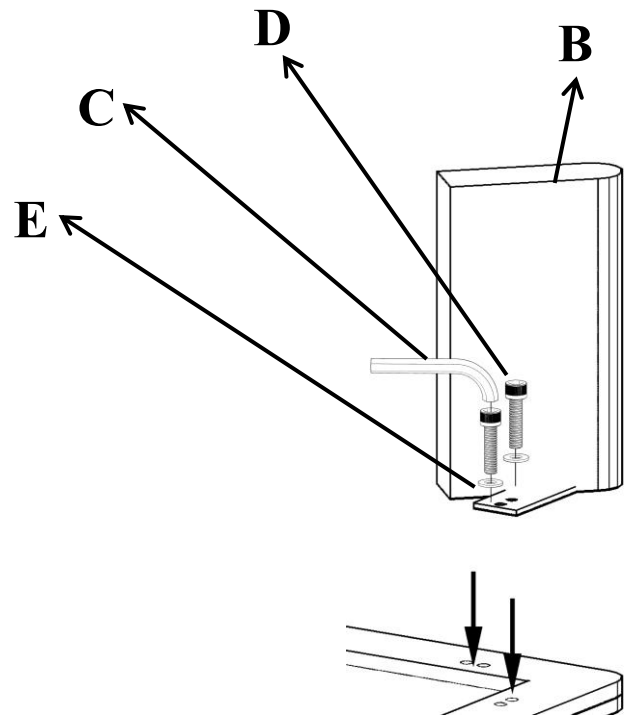

3

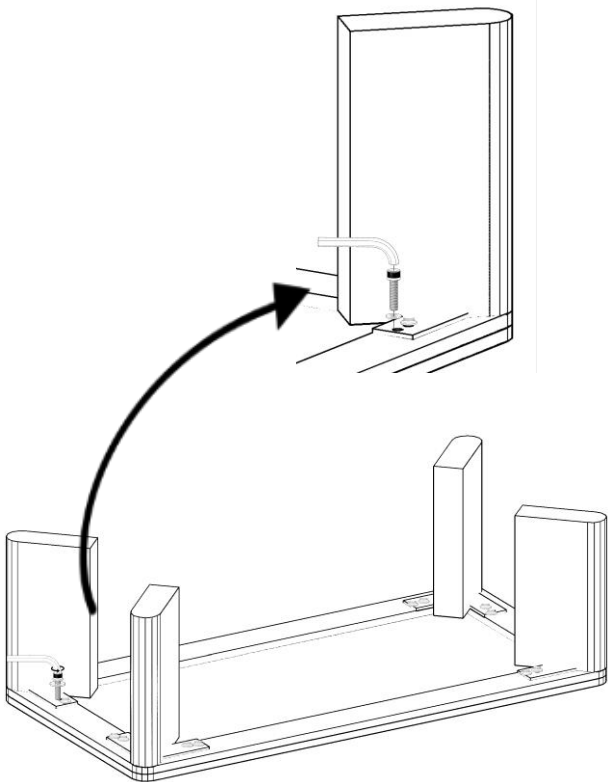

4

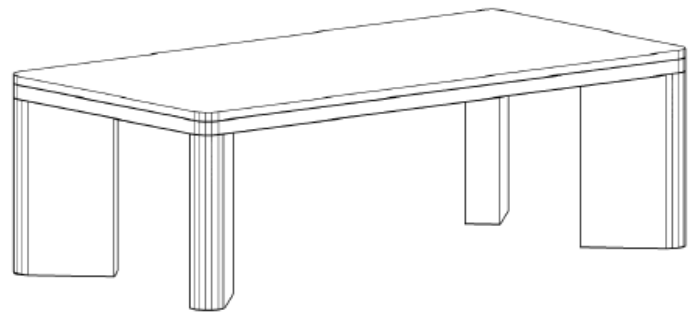

Now product is ready for use