

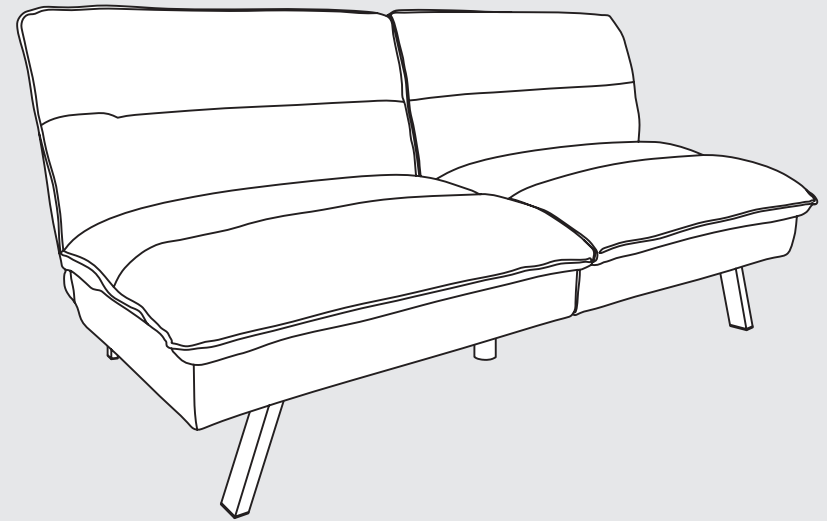

## FINGER GUARD

- U.S. Patent No. 8,875,321
- Provides Users a Permanent Safety Solution
- Eliminates the Risk & Liability of an Accident
- Heavy Duty, Fully Welded, Protective Metal Plate

## CONVERTIBLE SOFA



### ADULT ASSEMBLY REQUIRED

If you are missing any parts or have any questions regarding assembly, do not return this item to the retailers store. Please call our toll-free, customer service number and have this assembly manual open to the parts list ready to provide the model name, number and part name or number.



**WARNING:** This product may contain small components, please ensure they are kept away from small children.

## PARTS

Avoid using sharp objects such as a knife to cut open packing as you may accidentally damage the upholstery.

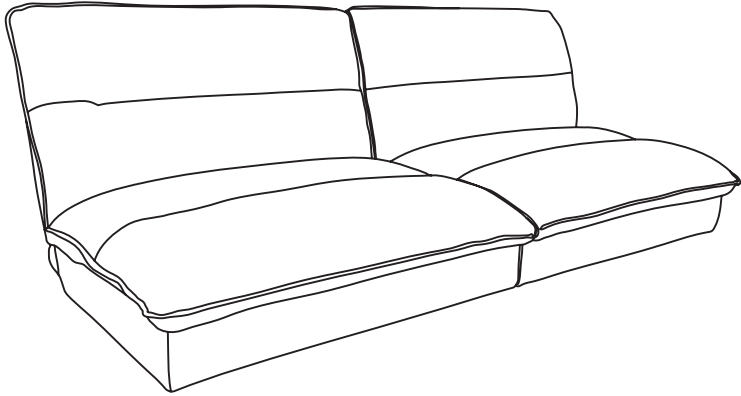

A. Sofa Body  
1x

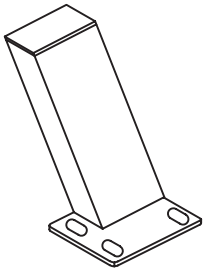

B. Left Front Leg  
1x

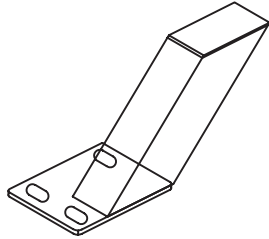

C. Right Front Leg  
1x

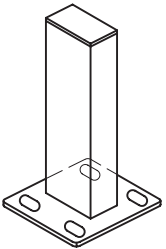

D. Back Legs  
2x

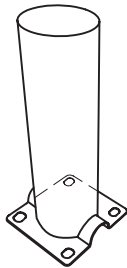

E. Center Support Legs  
2x

**4** Operate your convertible sofa by pushing the backrest forward, this will release the sofa to the bed position. Lift the backrest up to transition from bed position to either lounge or sofa position. This sofa has a split back which will allow you to operate either the left or right side independently.

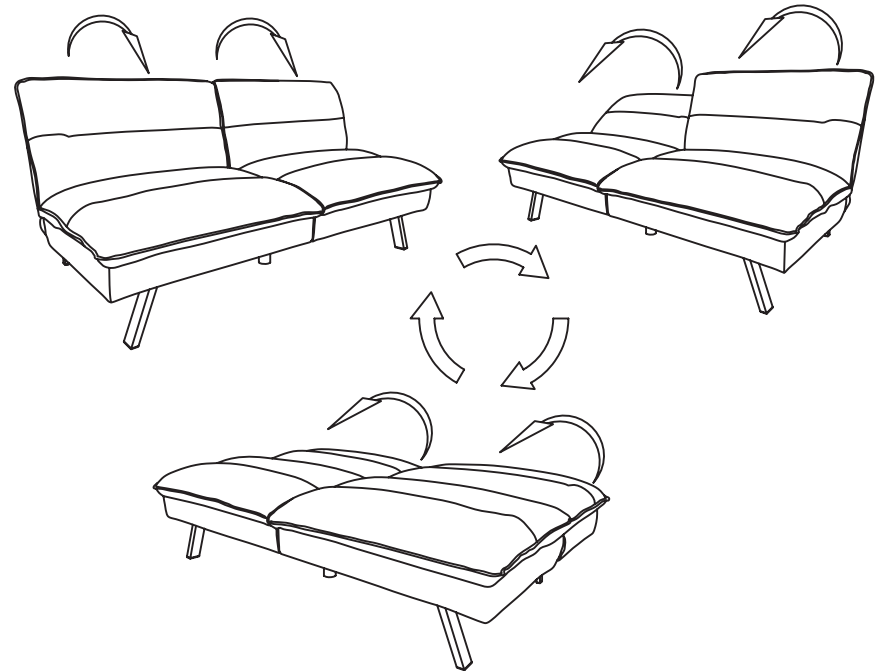

- 3** Attach Center Support Leg (E) to Sofa Body (A) using Bolt (3).  
Tighten using provided Allen Key (5).

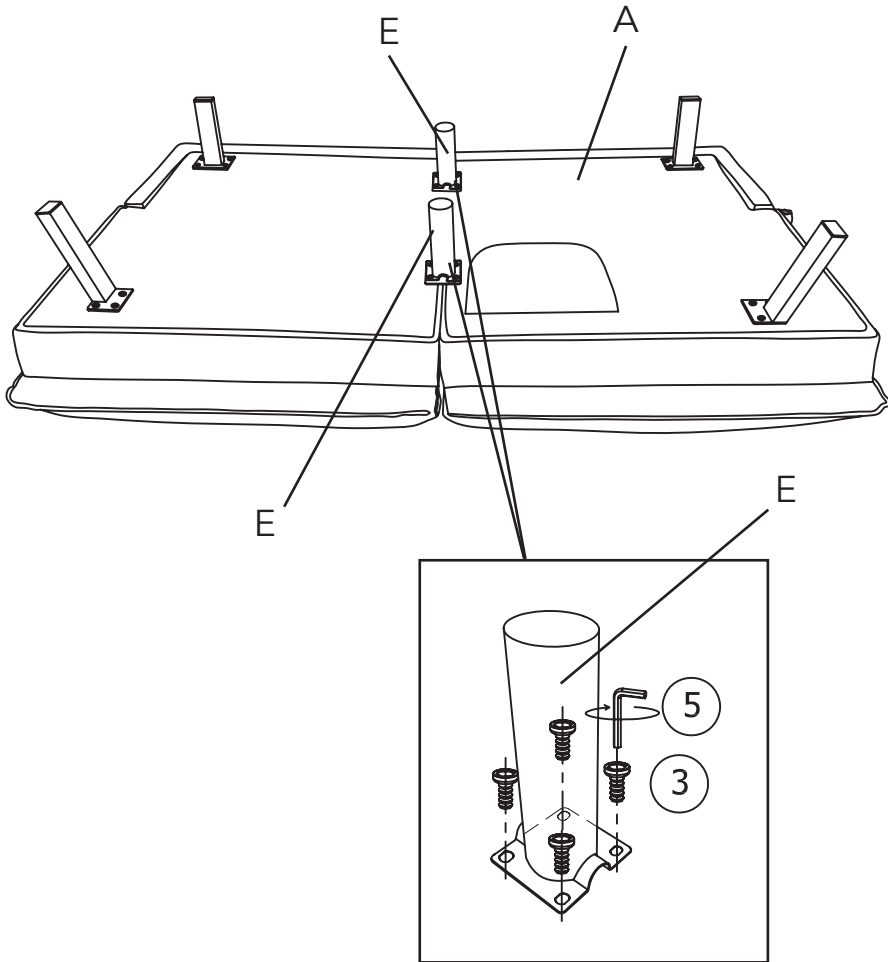

**HARDWARE**

Avoid using sharp objects such as a knife to cut open packing as you may accidentally damage the upholstery.

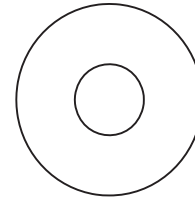

1. Washer  
14x

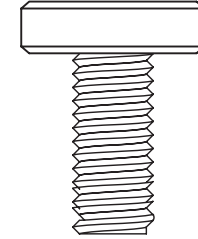

2. Bolt 5/16" x 1"  
14x

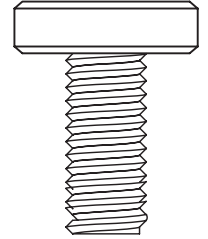

3. Bolt 1/4" x 1/4"  
8x

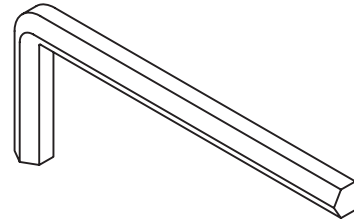

4. 5mm Allen Key  
1x

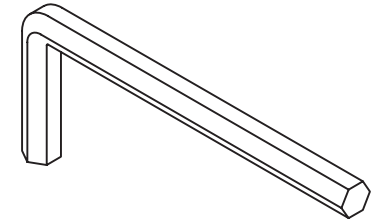

5. 4mm Allen Key  
1x

## ASSEMBLY INSTRUCTIONS

Do not fully tighten bolts until assembly is complete.

- 1** Flip Sofa Body (A) over.  
Pull out Hardware and Parts from the zippered compartment.

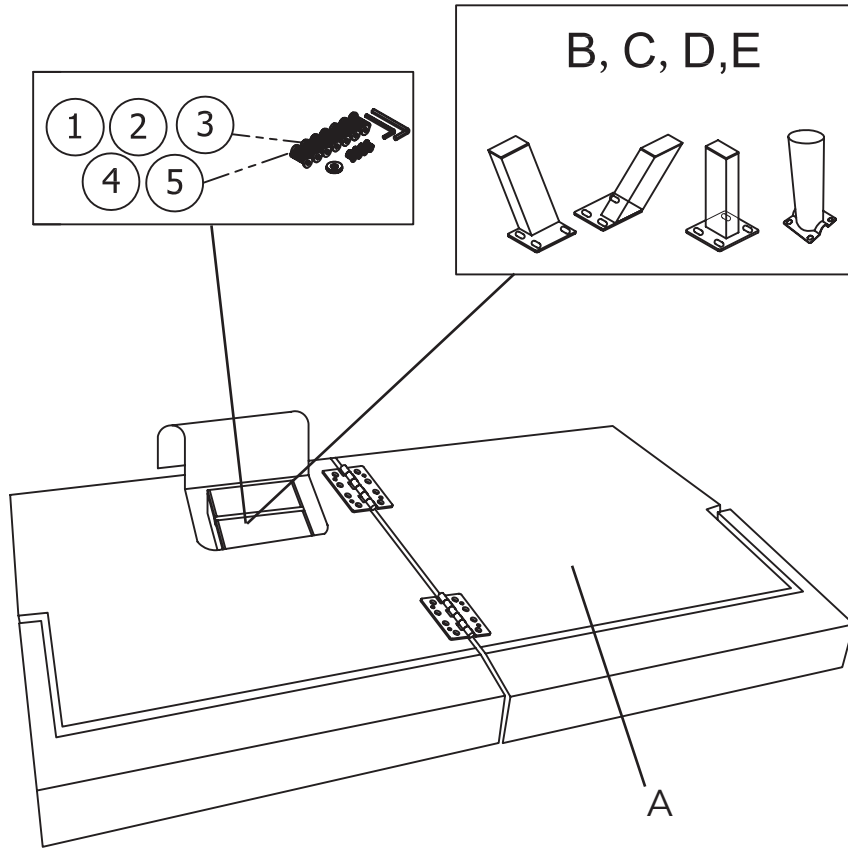

- 2** Attach Back Legs (D) to Sofa Body (A) using Bolt (2) and Washer (1).  
Tighten using provided Allen Key (4).

Then attach Left Front Leg (B) and Right Front Leg (C) to Sofa Body (A) using Bolt (2) and Washer (1). Tighten using provided Allen Key (4).

