

Tools Recommended

EN_IMPORTANT, RETAIN FOR FUTURE REFERENCE: READ CAREFULLY.

FR_IMPORTANT: A LIRE ATTENTIVEMENT ET À CONSERVER POUR CONSULTATION ULTÉRIEURE.

ES_IMPORTANTE, LEA Y GUARDE PARA FUTURAS REFERENCIAS.

PT_IMPORTANTE, RETER PARA REFERÊNCIA FUTURA: LEIA ATENTAMENTE.

DE_WICHTIG! SORGFÄLTIG LESEN UND FÜR SPÄTER NACHSCHLAGEN AUFBEWAHREN.

IT_IMPORTANTE! CONSERVARE IL PRESENTE MANUALE PER FUTURO RIFERIMENTO E LEGGERLO ATTENTAMENTE.

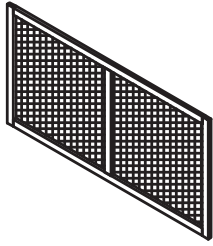

①x02



⑧x01

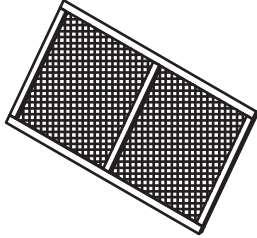

②x01

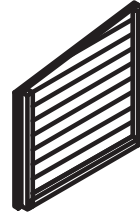

⑨x01

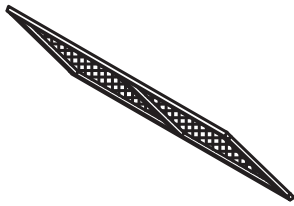

③x01

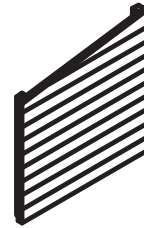

⑩x01



④x01

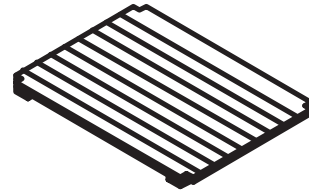

⑪x01



⑤x01

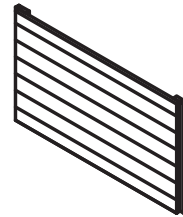

⑫x01

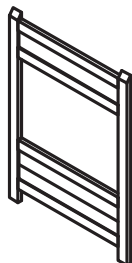

⑥x01

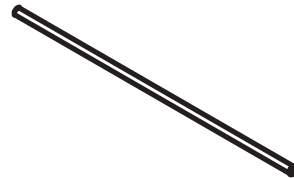

⑬x02



⑦x01

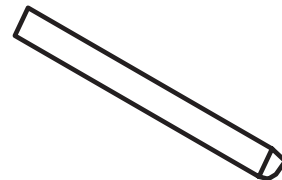

⑭x01

15 x01

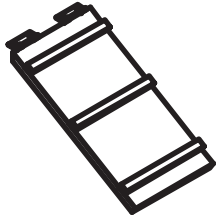

16 x01

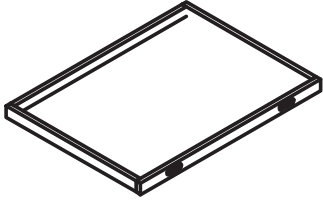

17 x02

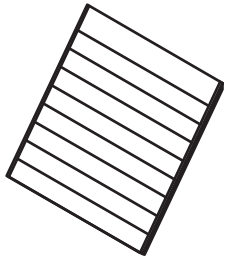

18 x01

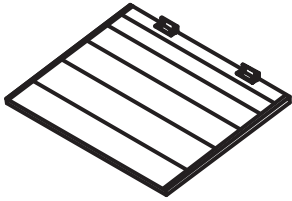

19 x01

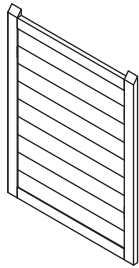

A x04+1(spare)



M6*50

B x08+1(spare)

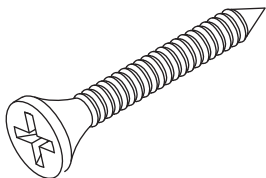

M3.5*40

C x30+2(spare)

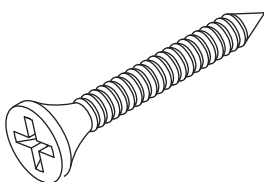

M3.5*35

D x04+1(spare)

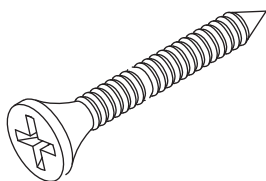

M3*20

E x08+1(spare)

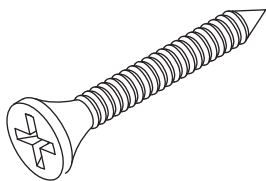

M3*16

EN Do not confuse similar screws.
FR Ne pas confondre des vis similaires.
ES No confunda tornillos similares.
PT Não confundir parafusos semelhantes.
DE Verwechseln Sie ähnliche Schrauben nicht.
IT Non confondere le viti simili.

NOTE

Cx08

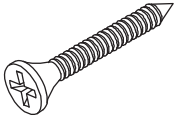

M3.5*35

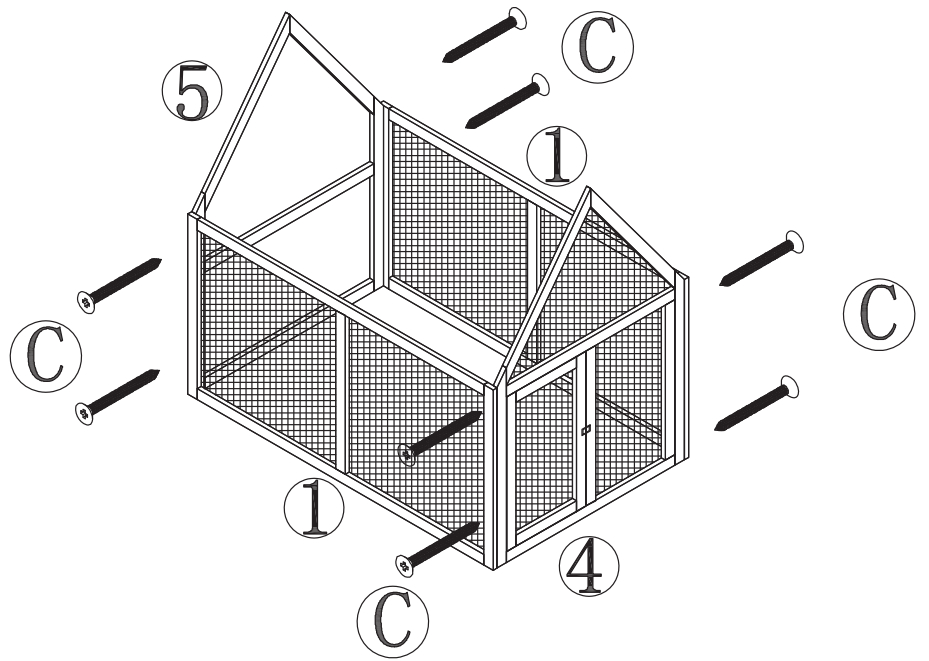

Cx04

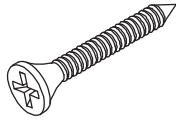

M3.5*35

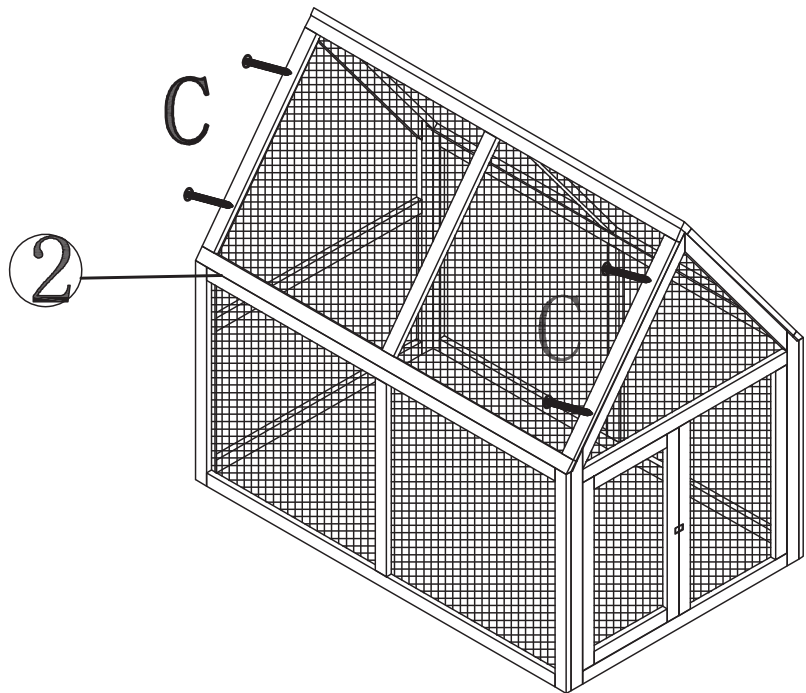

Cx06

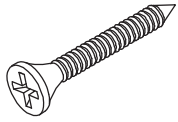

M3.5*35

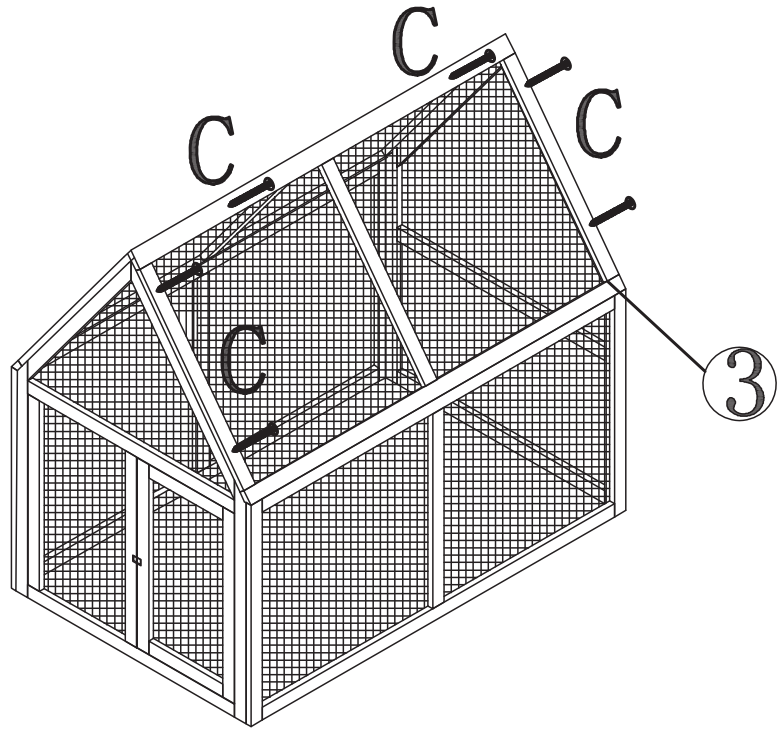

Bx04

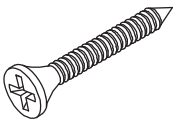

M3.5*40

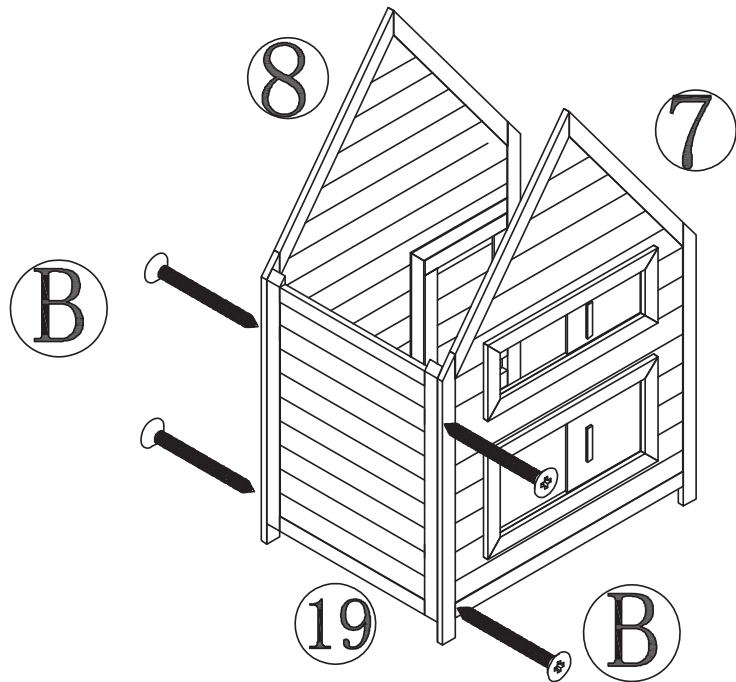

Bx04

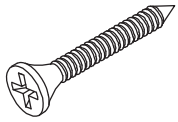

M3.5*40

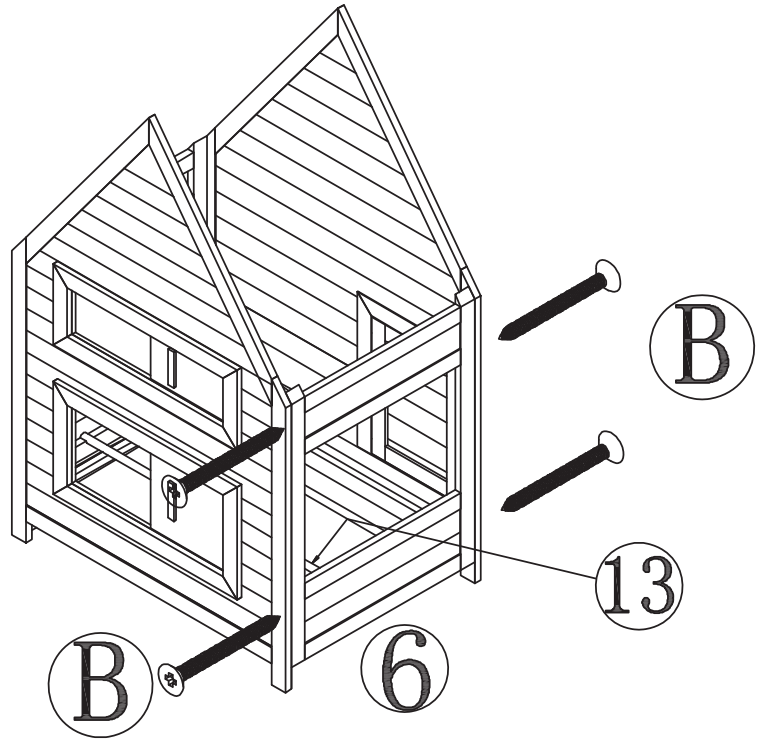

Ax04



M6*50

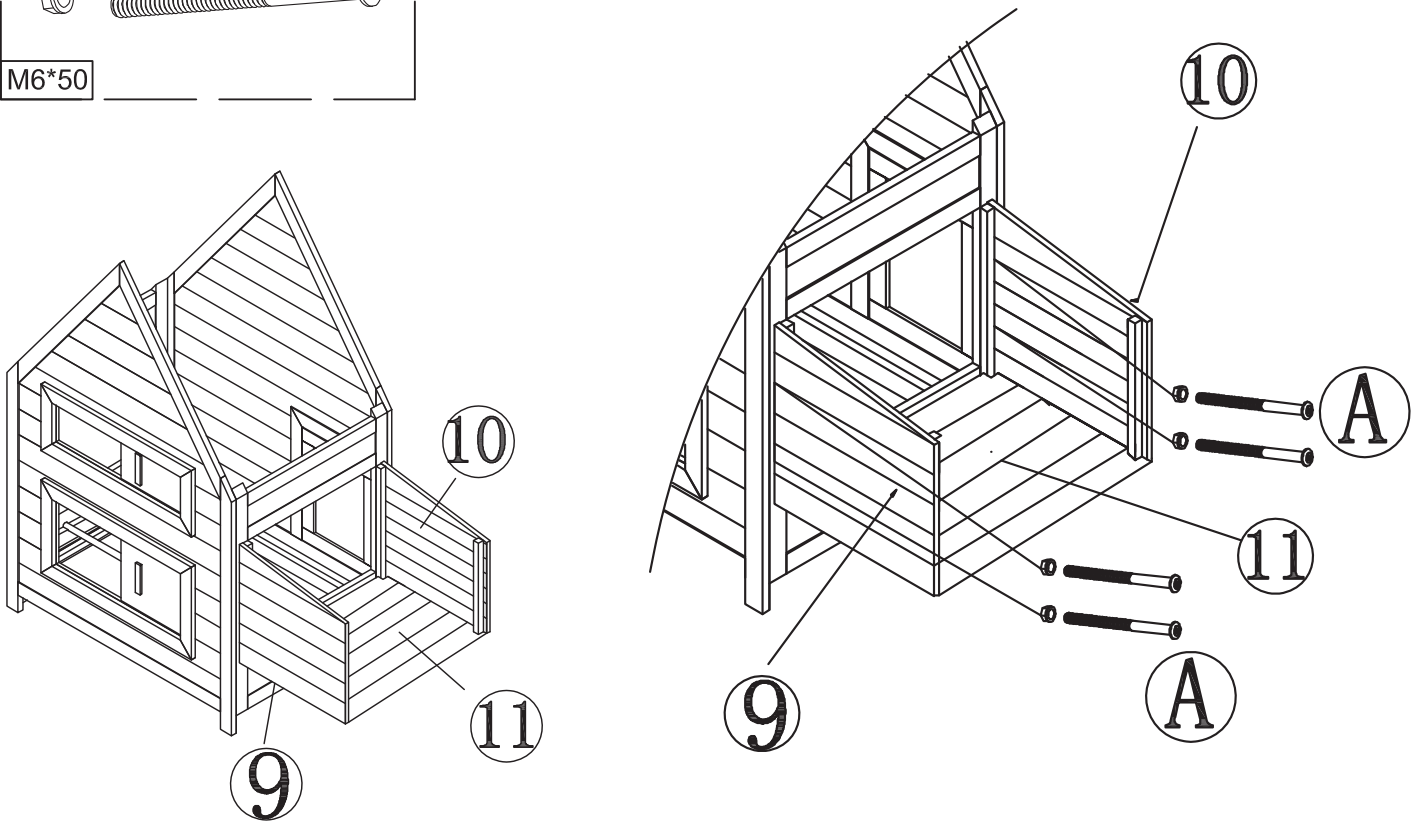

Cx04

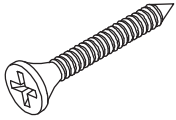

M3.5*35

Ex04

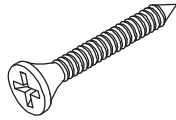

M3*16

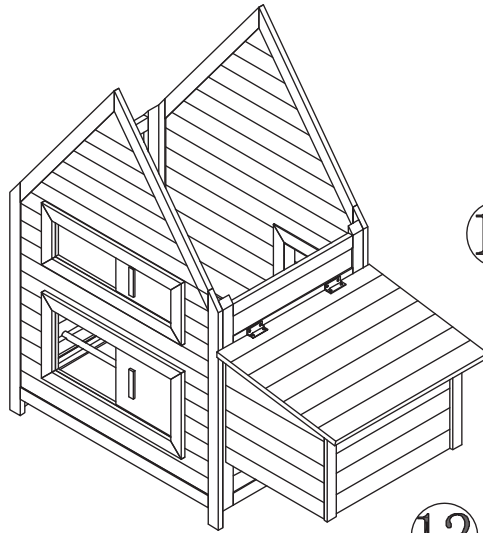

12

18

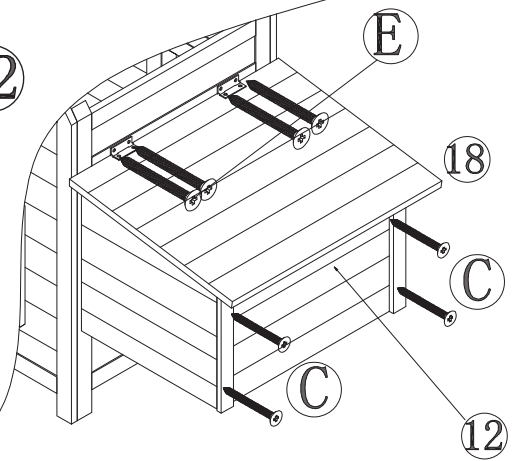

18

C

C

12

Cx08

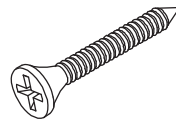

M3.5*35

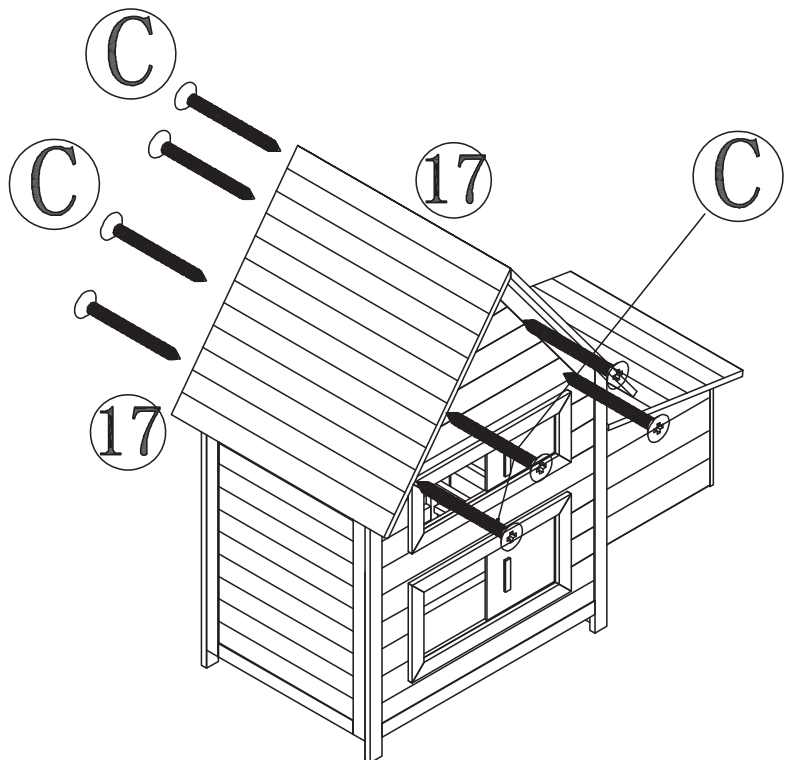

17

17

C

C

C

Dx04

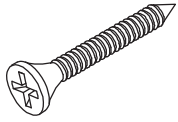

M3*20

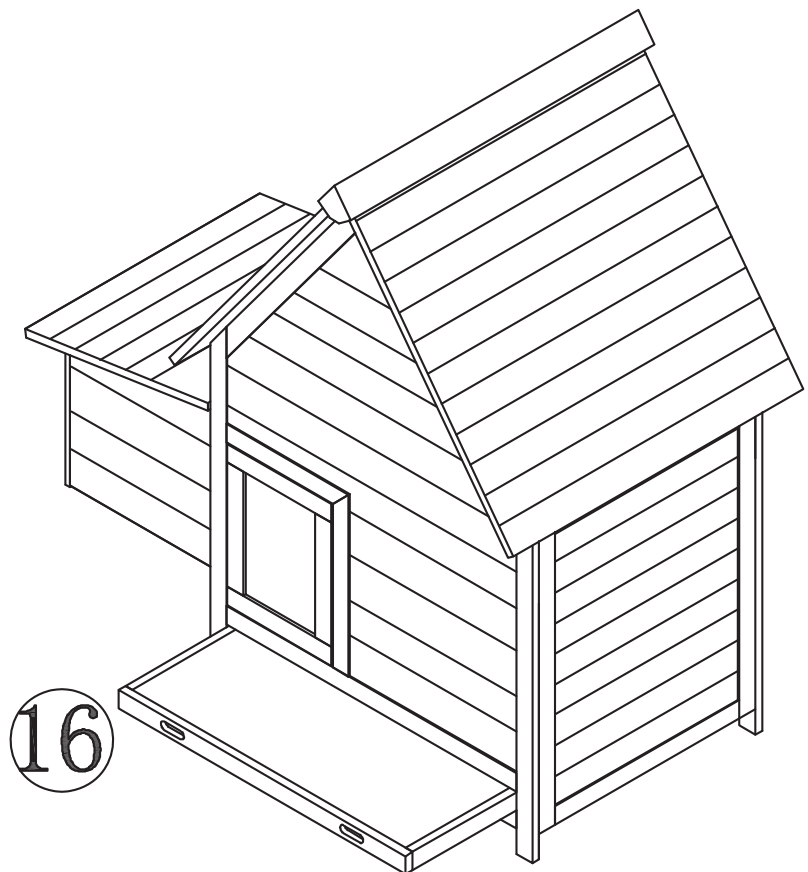
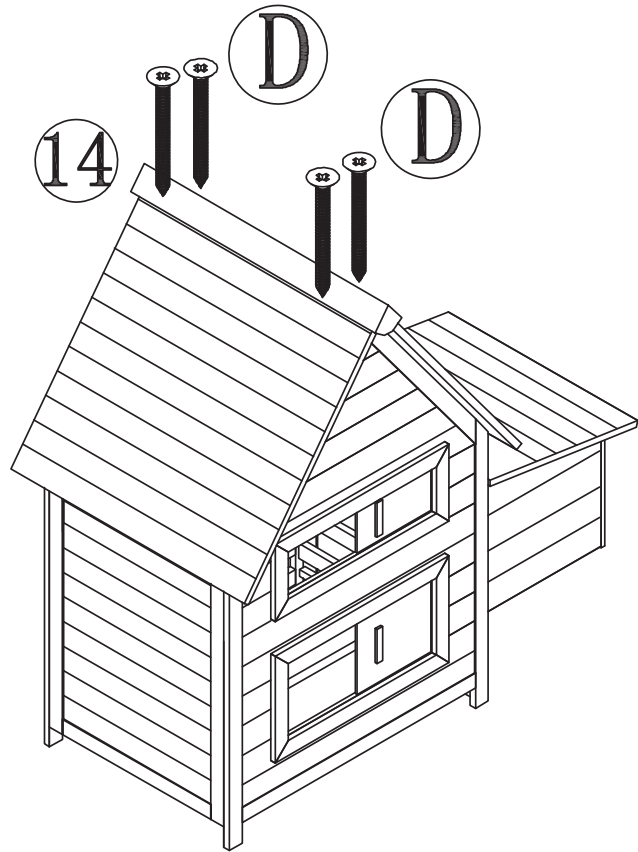

Ex04

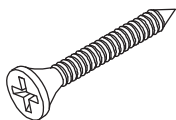

M3*16

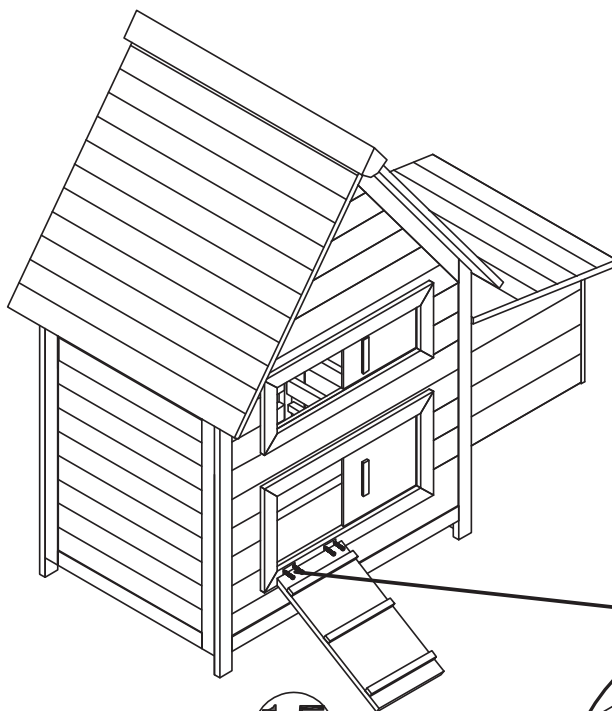

15

