

Assembly Instruction

ITEM NO.: TDL212303DS

- 1) Add the Tube (3) on the Socket (2).
- 2) Add the Shade (4) onto the Tube (3).
- 3) Add the Finial (5) onto the Tube (4).

CAUTION - Refer to the wattage caution label located near the lamp holder for recommended maximum wattage - Do not exceed recommended wattage.

WARNING - Do not attempt to replace the bulb while the lamp is plugged into a wall receptacle.

IMPORTANT SAFETY INSTRUCTIONS This portable lamp has a polarized plug (one blade is wider than the other) as a safety feature to reduce the risk of electric shock. This plug will fit in a polarized outlet only one way. If the plug does not fit fully in the outlet, reverse the plug. If it still does not fit, contact a qualified electrician. Never use with an extension cord unless plug can be fully inserted. Do not alter the plug.

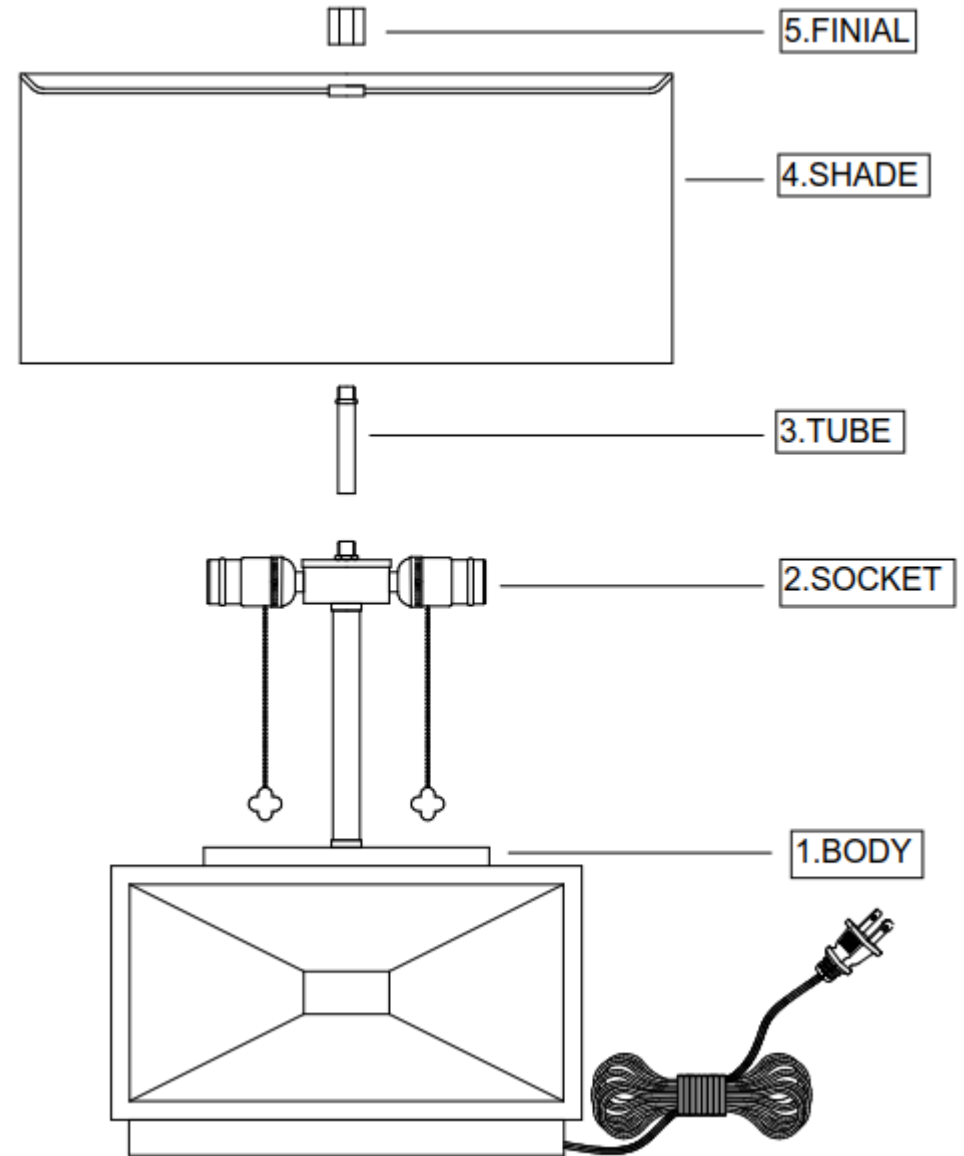

E26,TYPE A ,40W(NOT INCLUDED)