

Conservez ce manuel pour usage ultérieur
Save this manual for future reference



1-833-411-7372

www.SeraBathroomDesigns.com

CONSERVEZ CES INFORMATIONS
KEEP THIS INFORMATION

Date d'achat / Purchase date :

Suivi et Référence du Produit
Product Tracking Reference



1-833-411-7372

Thank you for your business.

If you experience difficulties with this product, do not return to the point of purchase. Please contact SERA BATHROOM DESIGNS directly, and we will replace defective parts free of charge.

.....

Nous vous remercions pour votre achat.

Si vous éprouvez des difficultés avec ce produit, ne le retournez à son point d'achat. Veuillez contacter SERA BATHROOM DESIGNS directement, et nous allons remplacer les pièces défectueuses a nos frais!

.....

Gracias por su compra.

Si usted tiene problemas con este producto, por favor de no regresarlo al mismo lugar donde lo adquirió. Contáctarse con la empresa SERA BATHROOM DESIGNS y reemplazarán las piezas defectuosas sin cargo.

1-833-411-7372

www.SeraBathroomDesigns.com

Installation d'installation Installation Instruction

GEN60MWTMR

SERA
BATHROOM
DESIGNS

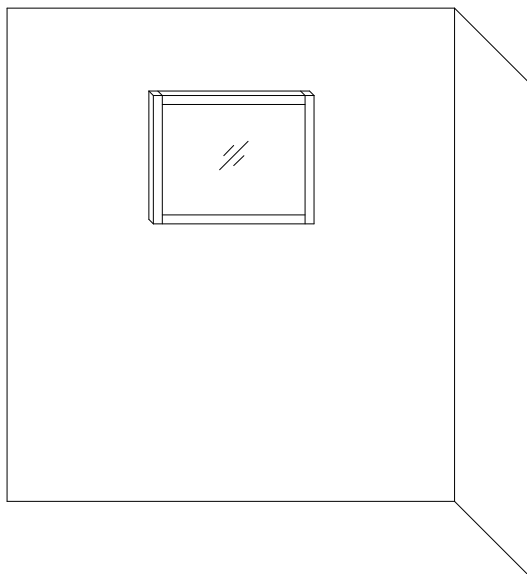

Installation tools (Not include)/Outilsd'installation(noninclus)

Name/Nom	Pic/Image	Name/Nom	Pic/Image
Electric Drill/ Perceuse Eledrique		Cross Screwdriver/ Tournevis Crucifome	
Hammer/ Marteau		Pencil/ Crayon	
Wrench/ Clé		Glass Cement/ Adhésf de Verre	
Levelling Rod/ Mire de Nivellement		Drill 10mm/ Foret 10mm	
		Drill 8mm/ Foret 8mm	
		Drill 6mm/ Foret 6mm	
Tapline/ Ruban à Mesuren			

Sparements/Pièces

Name/Nom	Code	Pic/Image	Qty/Qté	Name/Nom	Code	Pic/Image	Qty/Qté
Plastic expand screw $\Phi 8$ / Vis dexpansion plastique $\Phi 8$	G		2	Self-tapping screw ($\Phi 6 \times 60$)/ Vis Autotarudeus ($\Phi 6 \times 60$)	H		2
Double faced adhesive tape(50mm)/ Ruban Adhes Double Face(50mm)	F		2				

Step 1/Étape 1

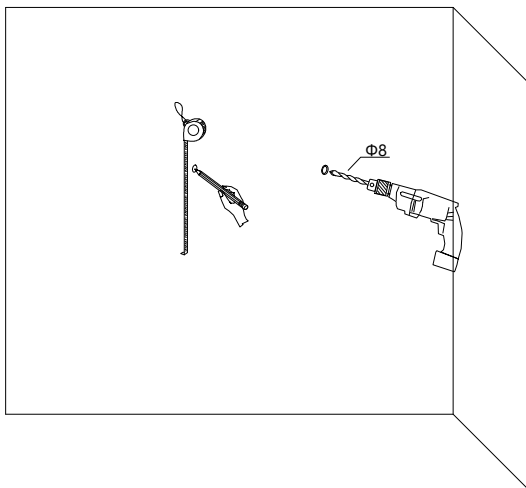

Step 2/Étape 2

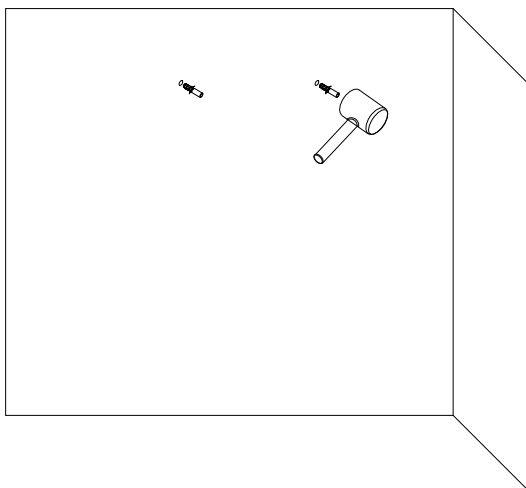

Step 3/Étape 3

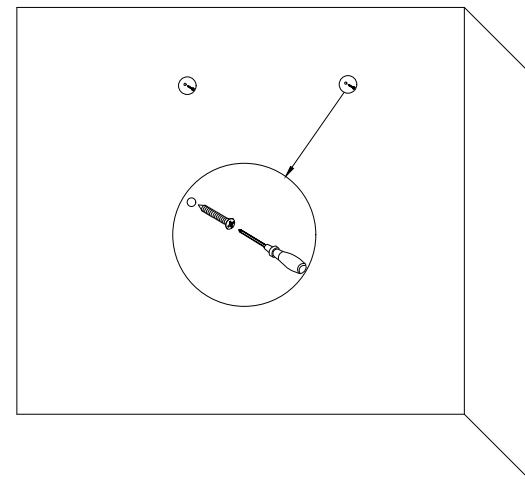

Step 4/Étape 4

