

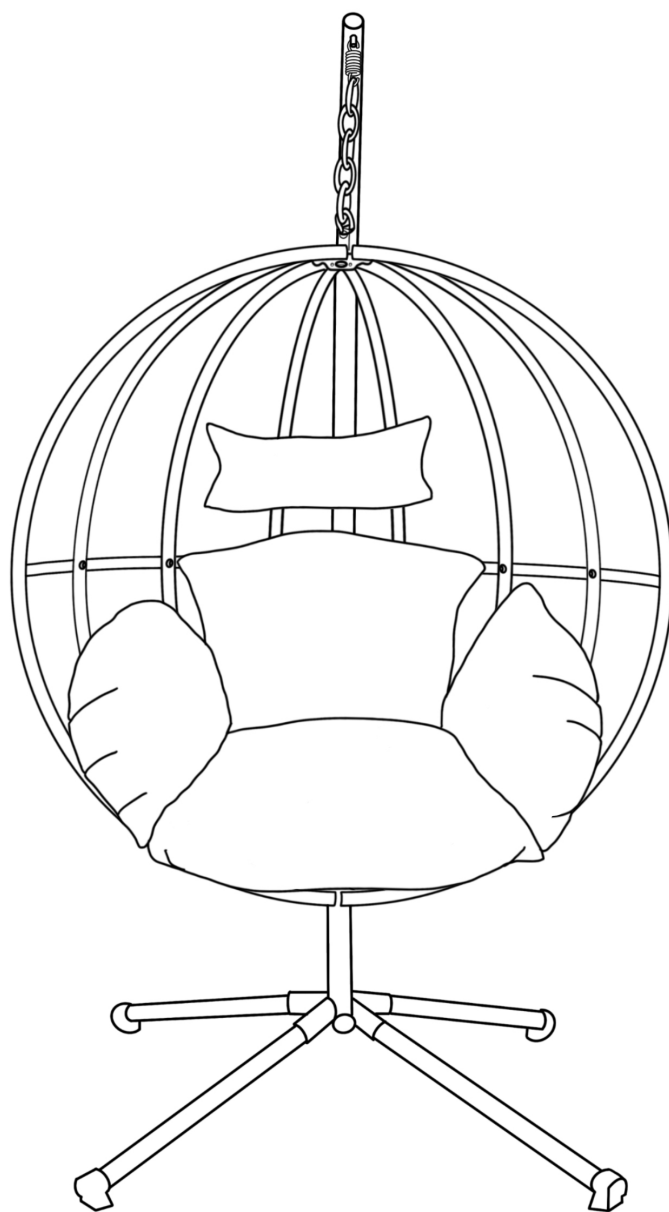





ASSEMBLY INSTRUCTION





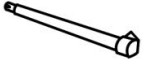

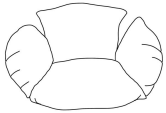





Hammock Swing

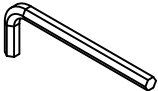
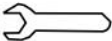

Parts List

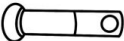
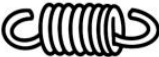
LABEL		DESCRIPTION	QTY
A		Swing Basket	1
B		Basket Support Leg	1
C		Suspension Rod	1
D		Base Support Leg	1
E		Leg	4
F		Pillow	1
G		Cushion	1

Hardware List

LABEL		DESCRIPTION	QTY
#1		Bolts M6 x 15 mm	+1 Spare 12
#2		Bolts M6 x 40 mm	+1 Spare 6
#3		Screws M10 x 60 mm	1
#4		Flat washer M6	+2 Spare 28
#5		Nut M6*10mm	+1 Spare 10
#6		Nut M10*15 mm	2
#7		Allen wrench M4	1
#8		Wrench 10*10	1
#9		Wrench 15*15	2
#10		Round Cap Bar	2
#11		Hook Spring	1
#12		Chain	1
#13		Spring	1
#14		Rotation Shaft	1
#15		Safety Belt	1

1

#1 x4PCS
M6*15mm

#4 x8PCS
M6

#5 x4PCS
Nut M6

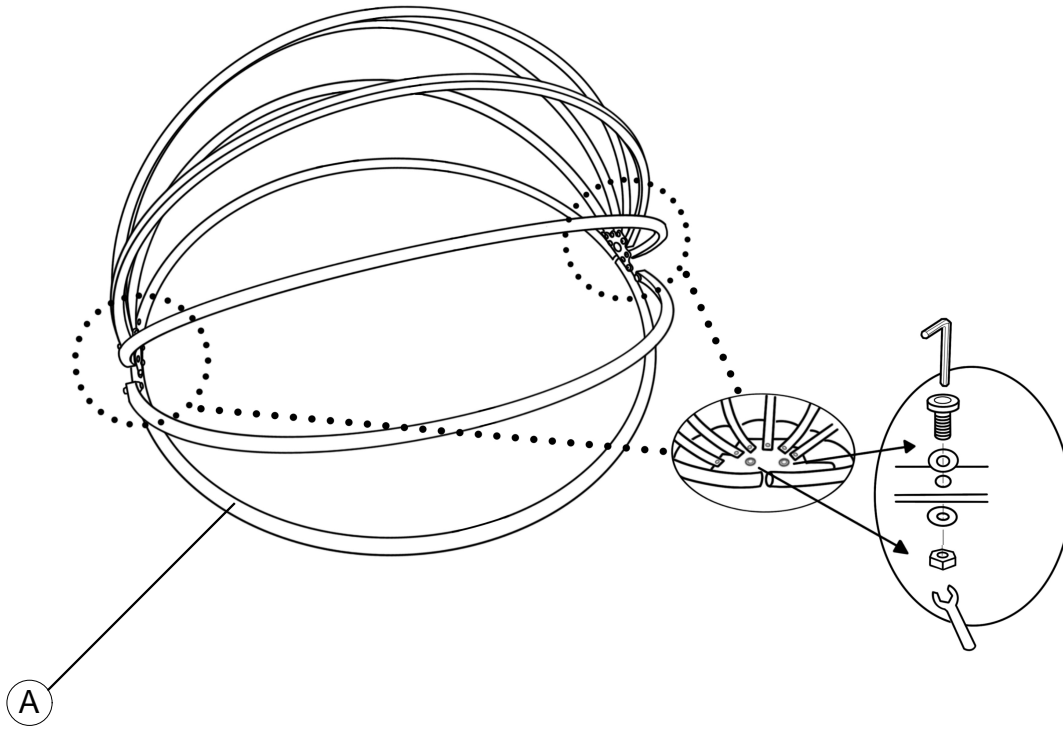
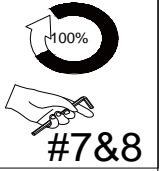

2

#1 x2PCS
M6*15mm

#4 x2PCS
M6

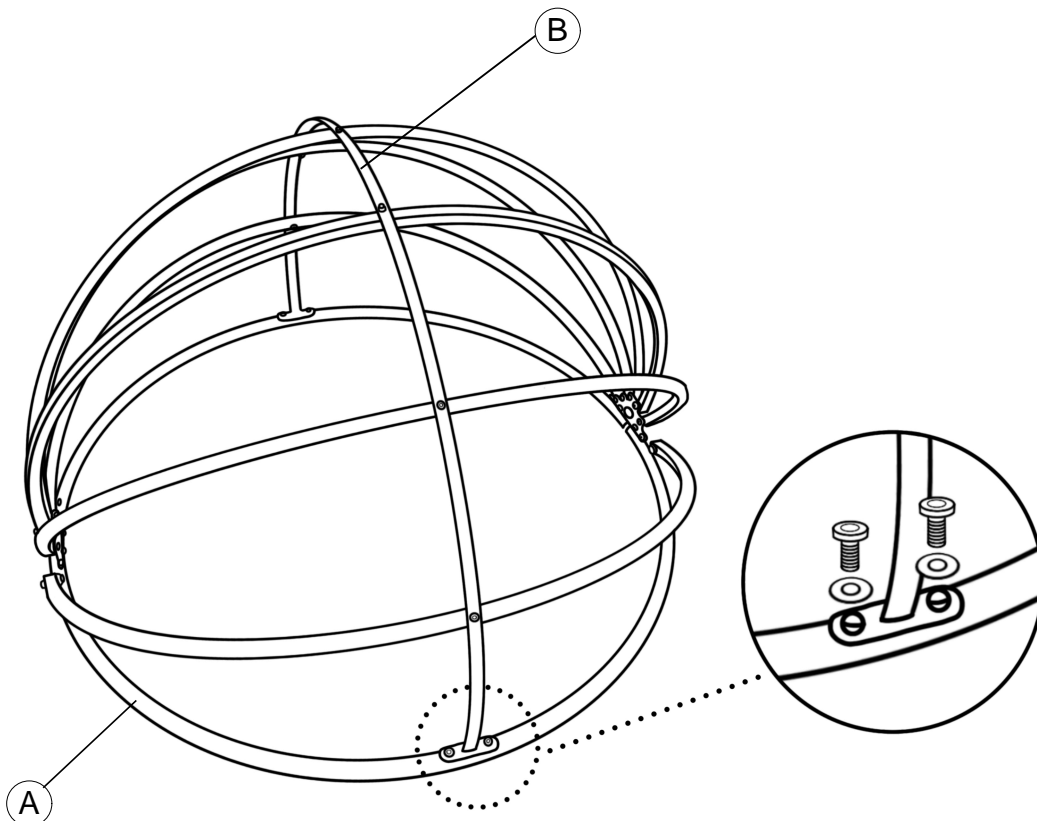
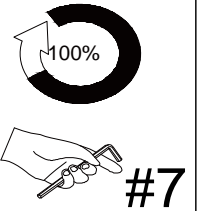

3

#2 x6PCS



M6*40mm

#4 x12PCS



M6

#5 x6PCS



Nut M6



#7&8

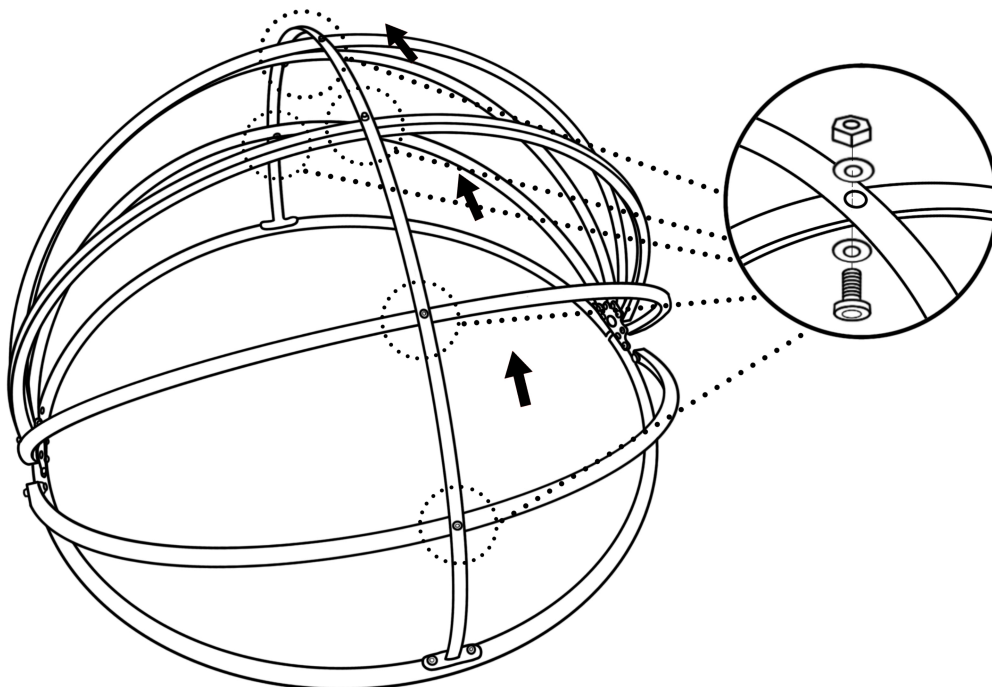

4

#1 x2PCS



M6*15mm

#4 x2PCS



M6

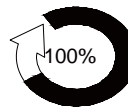

#7

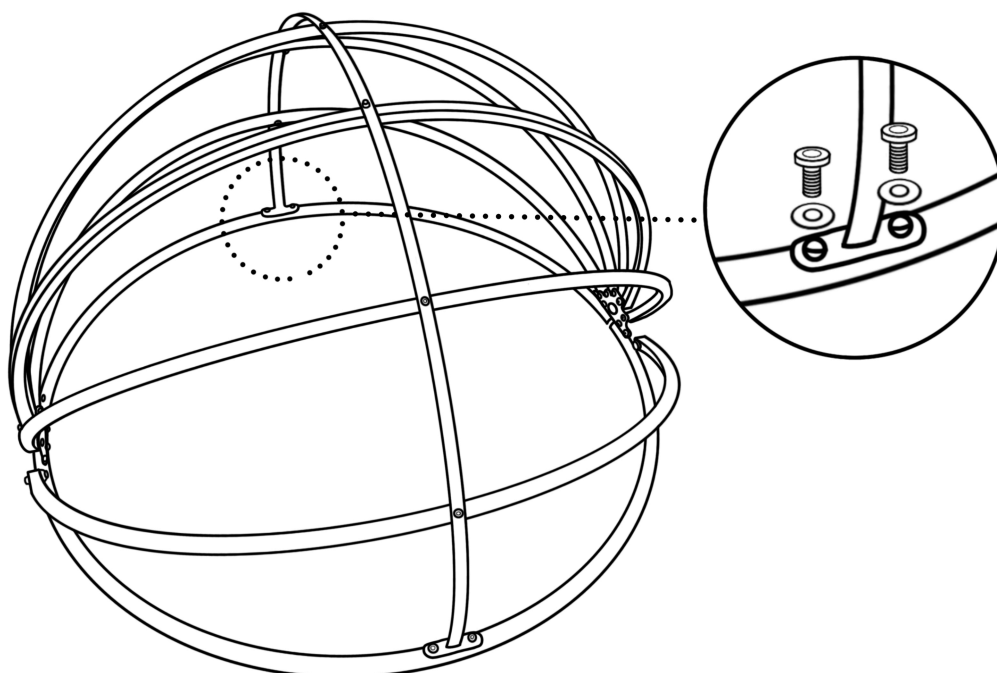

5

#1 x 4PCS



M6*15mm

#4 x 4PCS



M6

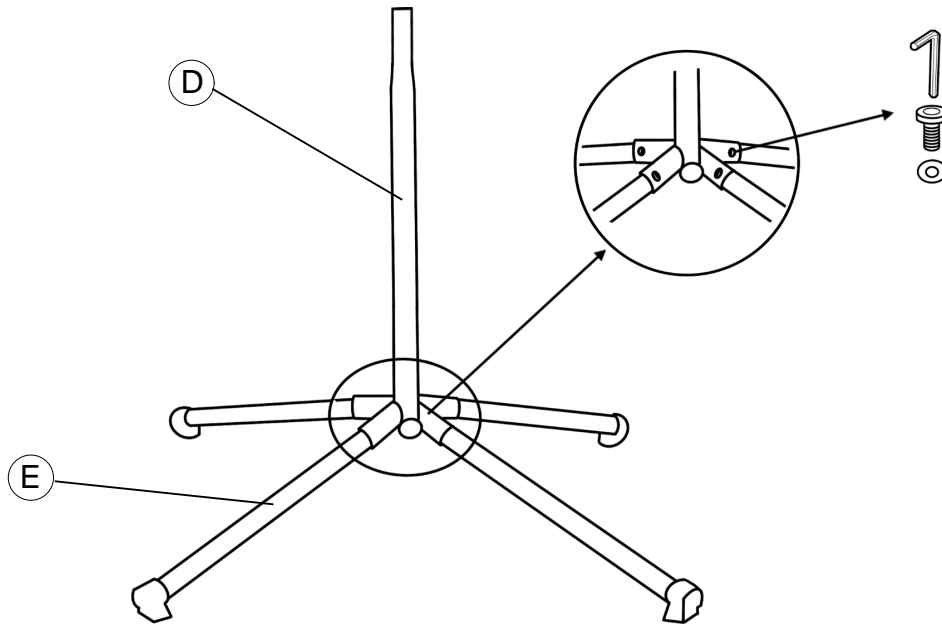
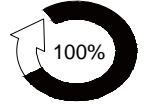

6

#3 x 1PCS



M10*60mm

#6 x 2PCS



M10*15

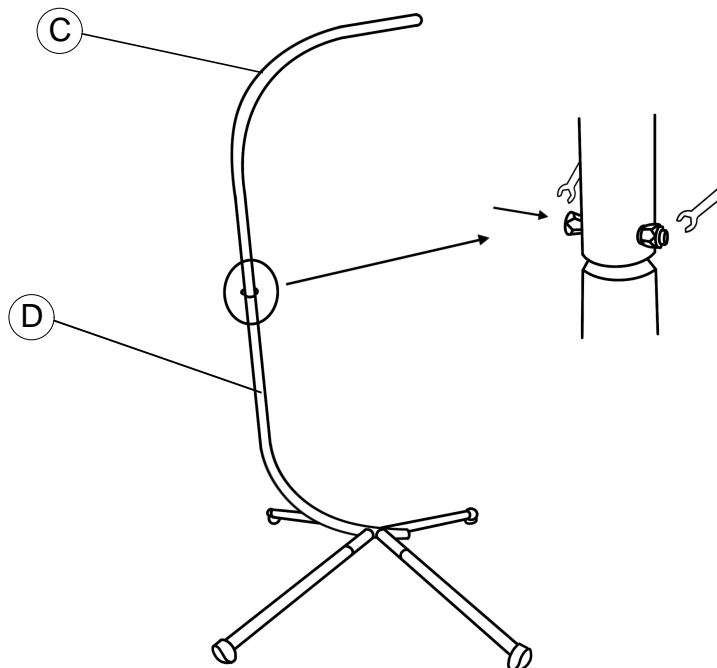
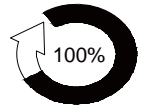

7

#10x2PCS

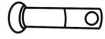

#11x 1PCS



#12x1PCS



#13 x1PCS



#14 x1PCS

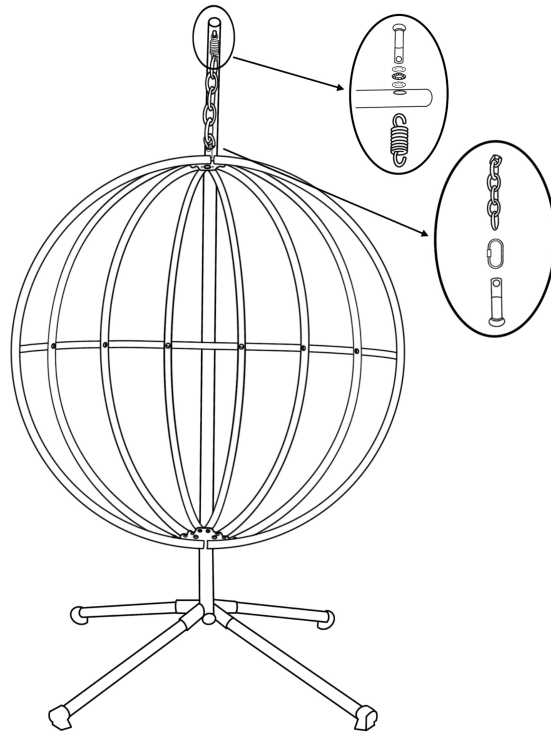

8

#15x1PCS

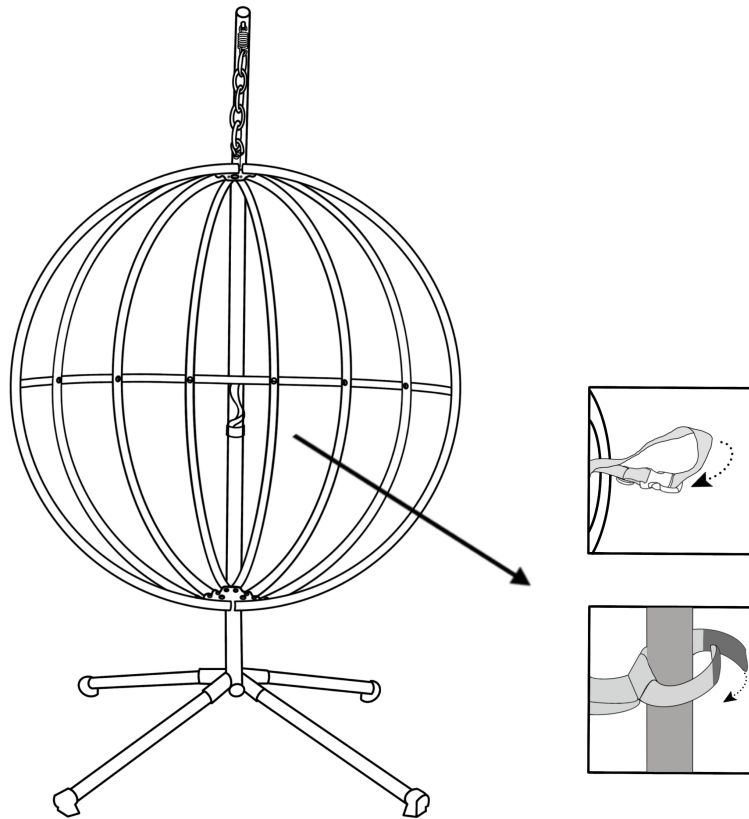

9

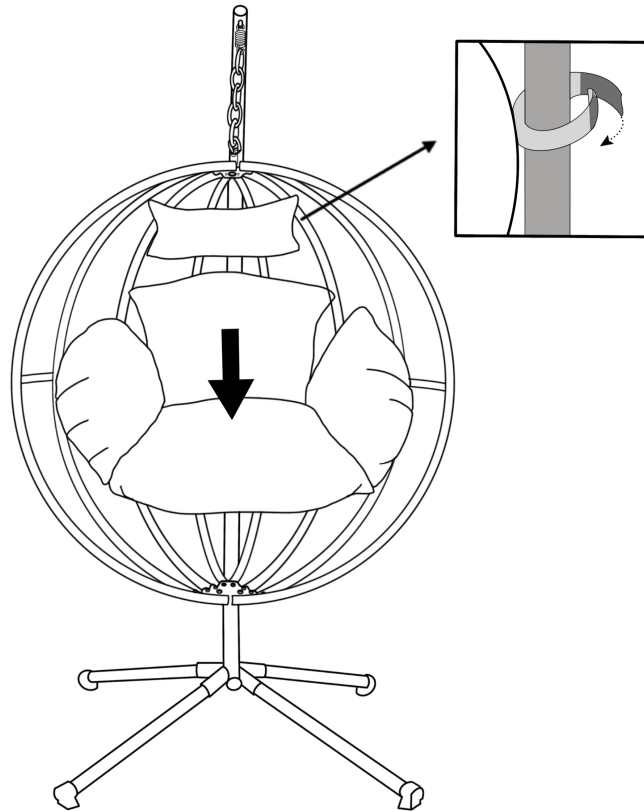

10

