

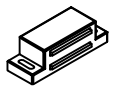



A	x 1
	

B	x 2
	

C	x 8
	

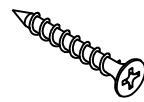
D	x 4
	

E	x 12
	

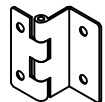
F	x 2
	

G	x 1
	

H	x 10
	

I	x 1
	

J	x 1
	

K	x 4
	

1

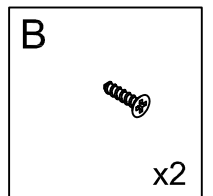
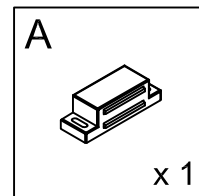
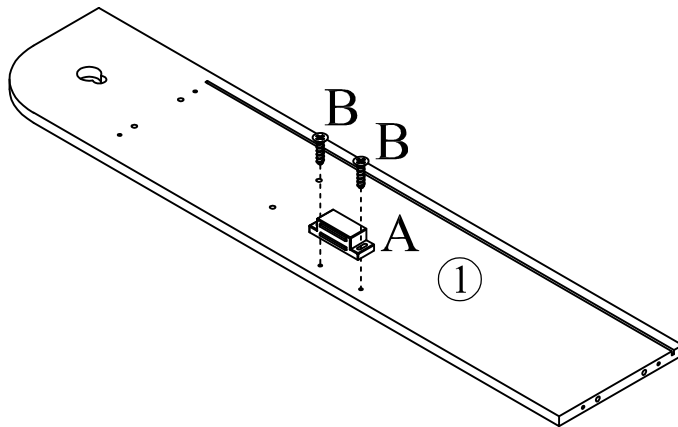

2

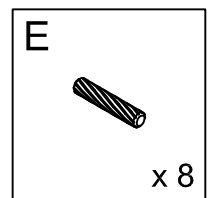
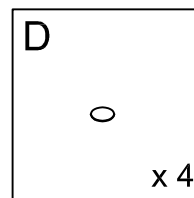
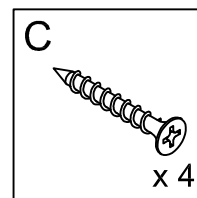
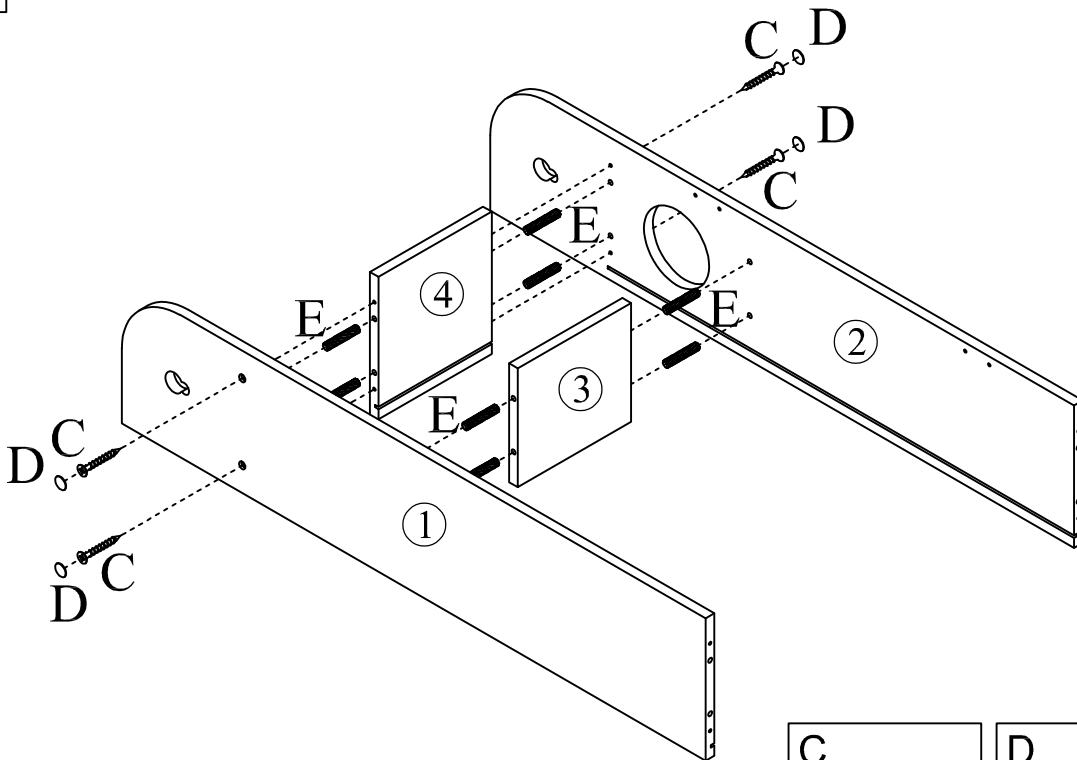

3

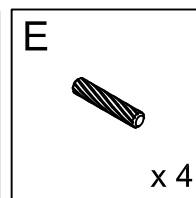
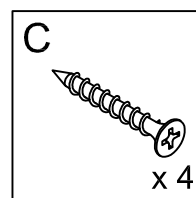
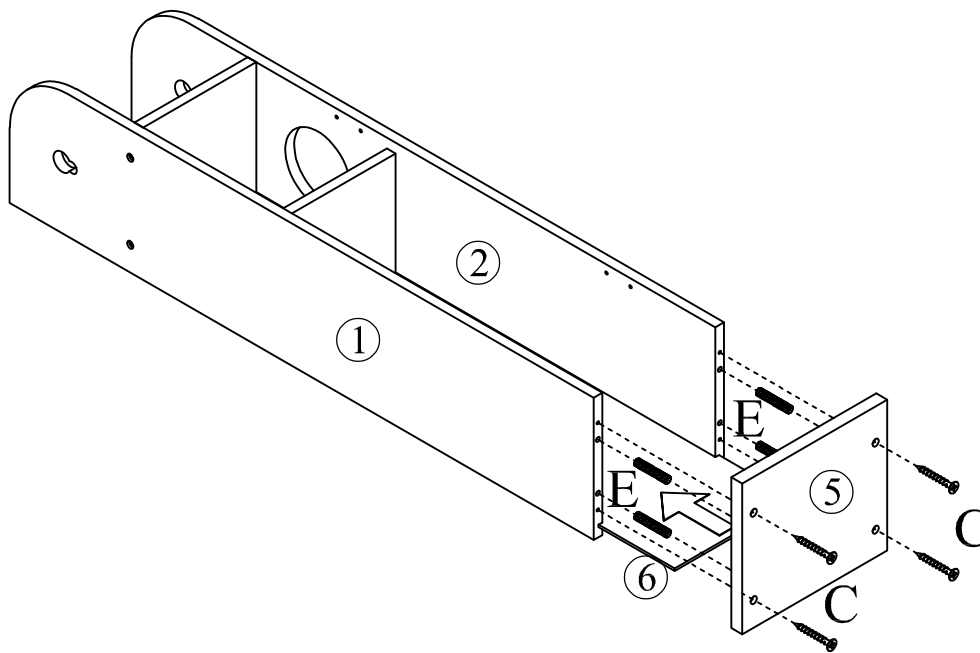

4

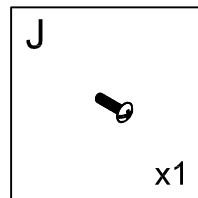
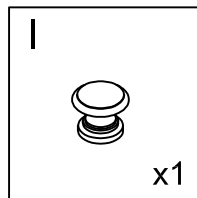
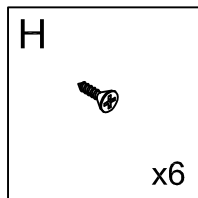
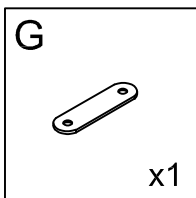
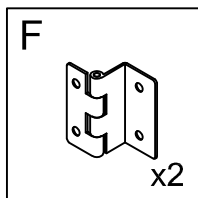
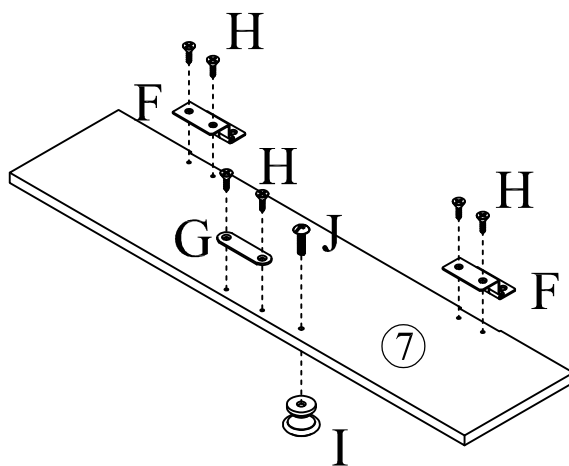

5

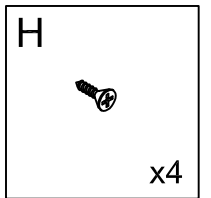
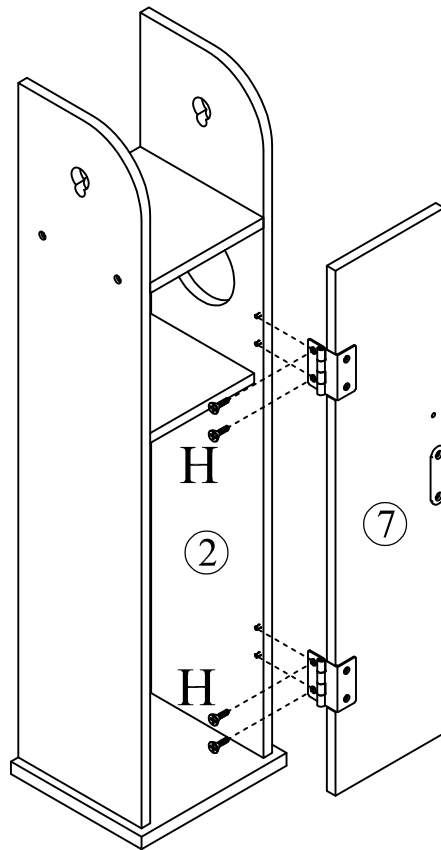

6

