

Twelve Drawer Dresser





IMPORTANT INFORMATION!

please read the entire manual before starting to assemble and/or using this product. follow the manual thoroughly and keep it for further reference.

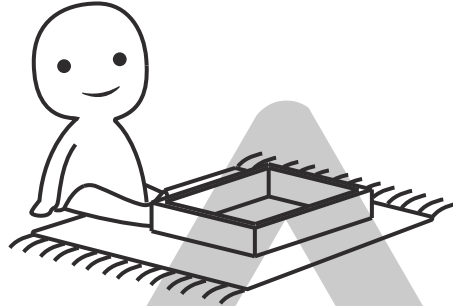
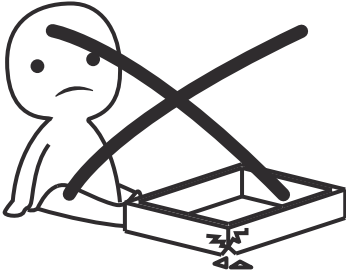

AVOID SCRATCHES!

In order to avoid scratching this furniture should be assembled on a soft layer-could be a rug.

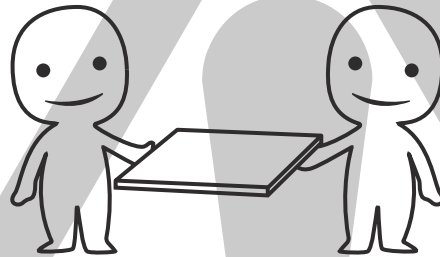

IMPROVE EFFICIENCY !

Try to find a partner to install with you, which can speed up the installation efficiency and shorten the time.

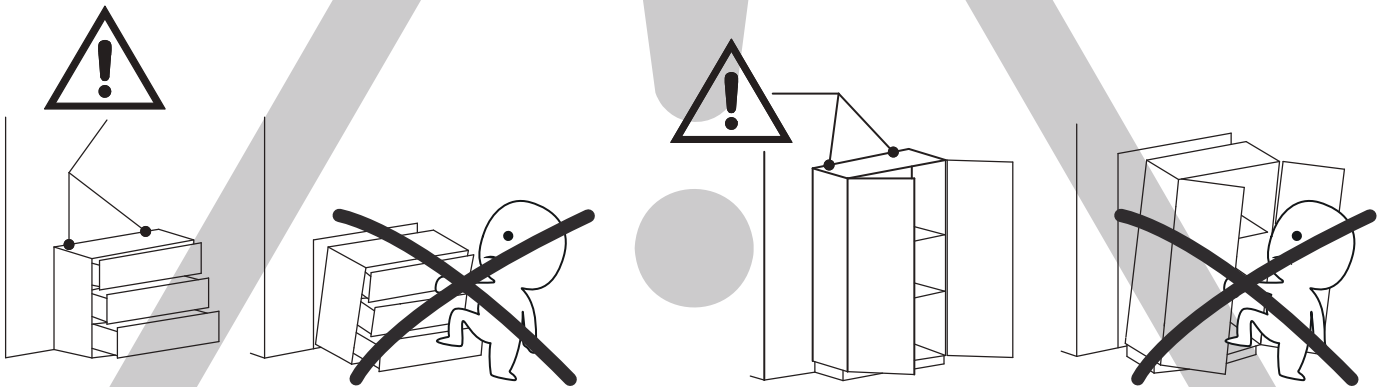

ANTI-TOPPLE WARNING !

Overtipped furniture can cause serious or fatal crush injuries. To prevent tipping over, be sure to use the wall attachment, if not included with this product. Please purchase the wall attachment that fit your wall. If unsure, seek professional advice. Please read and follow each step of the instructions carefully.

IMPORTANT !

It is important that any product which is assembled using any kind of screw is re-tightened 2 weeks after assembly, and once every 3 months - in order to assure stability through-out the lifespan of the product.

For regular maintenance and cleaning of the product, for the frame, please use a rag dipped in neutral detergent to fully wipe it, and then dry it with a clean rag. For glass materials, wipe with a rag dampened with water glass cleaner, and then dry with a dry rag.

Do not use an electric screwdriver, and do not use too much force when installing, because the board is easy to break.

Board Identification

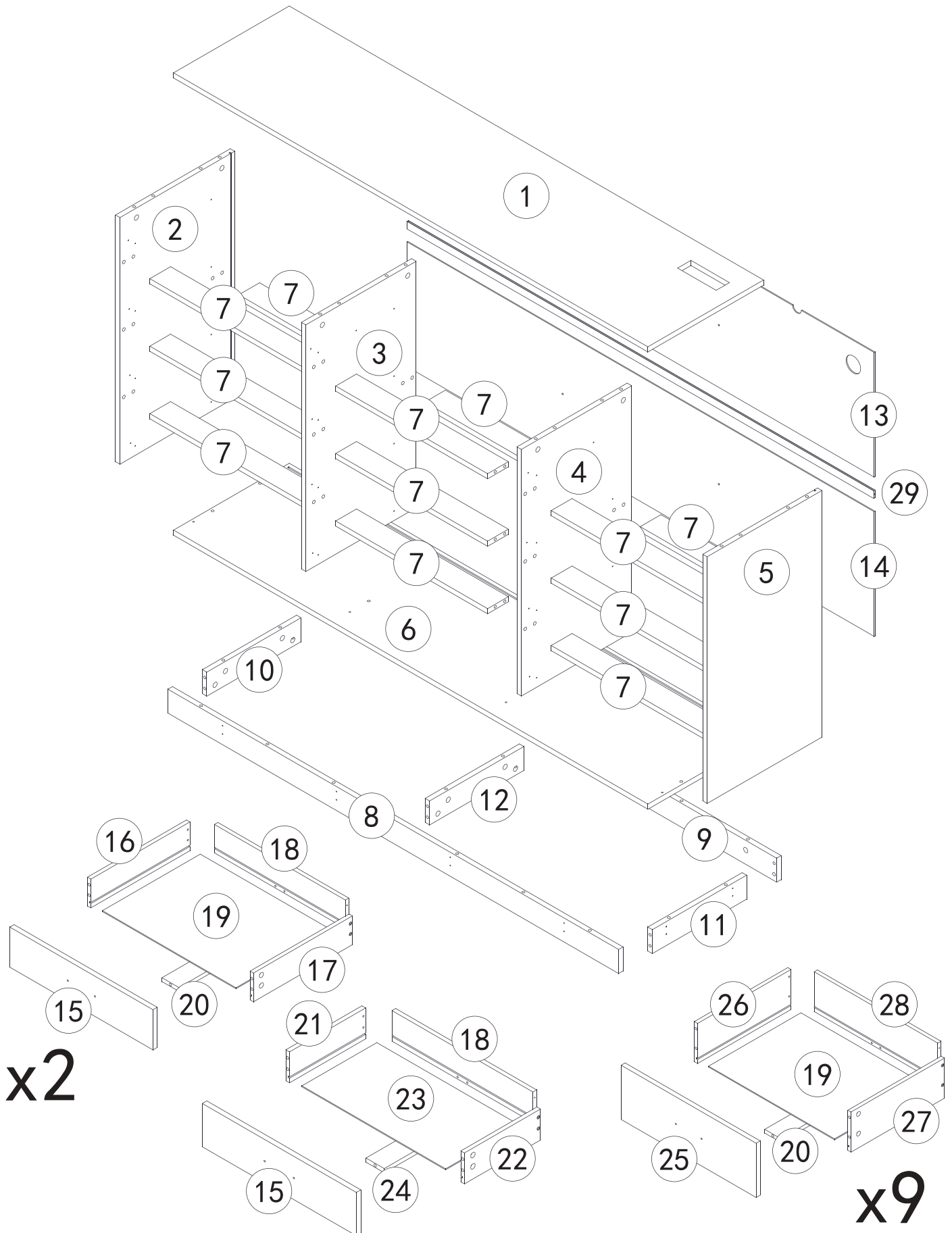

PARTS LIST

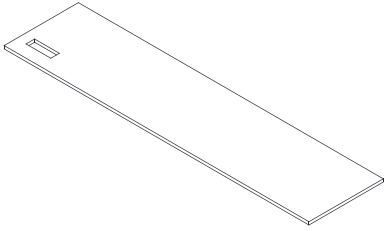

①

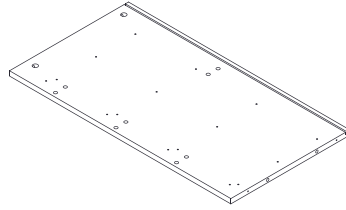

②

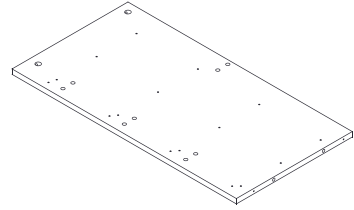

③

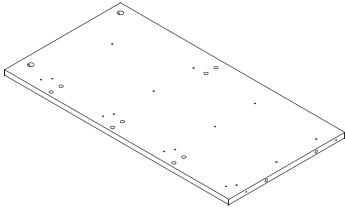

④

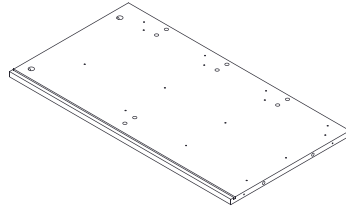

⑤

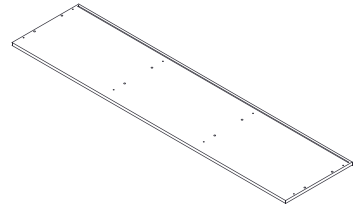

⑥

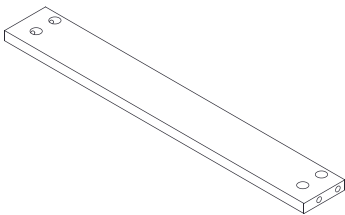

⑦ x12

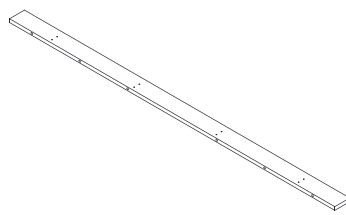

⑧

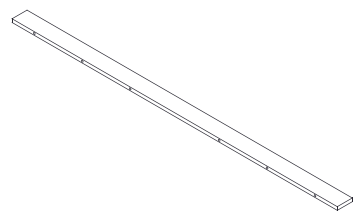

⑨

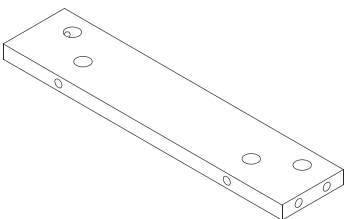

⑩

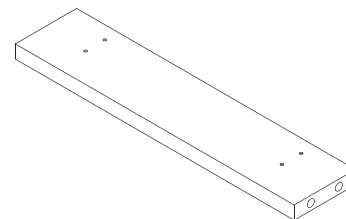

⑪

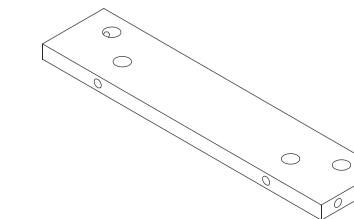

⑫

PARTS LIST

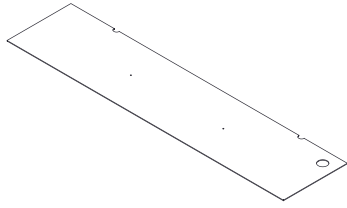

⑬

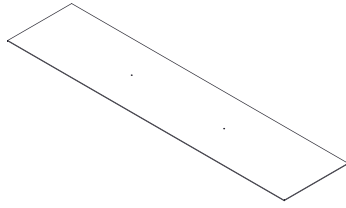

⑭

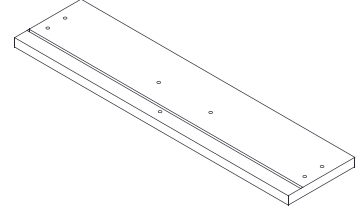

⑮ x3

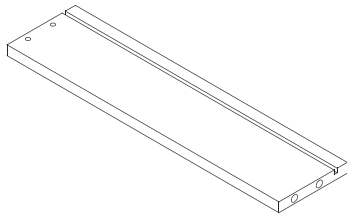

⑯ x2

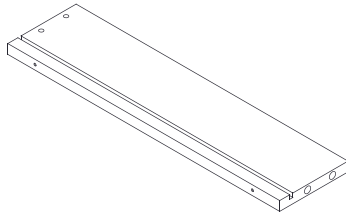

⑰ x2

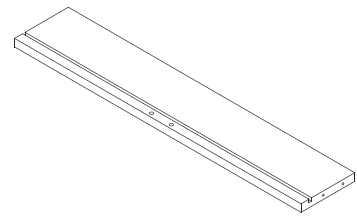

⑱ x3

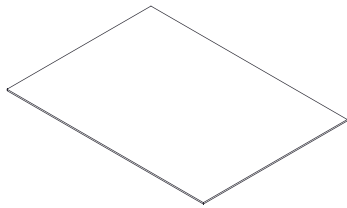

⑲ x11

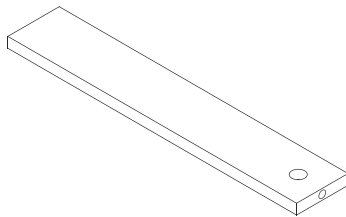

⑳ x11

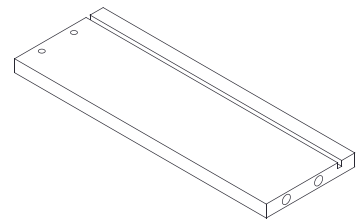

㉑

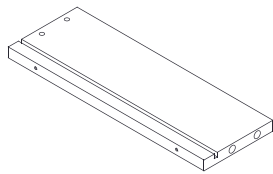

㉒

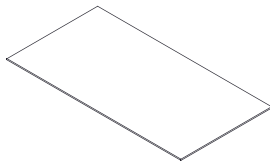

㉓

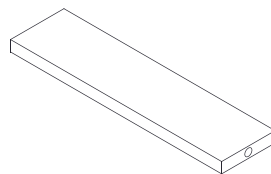

㉔

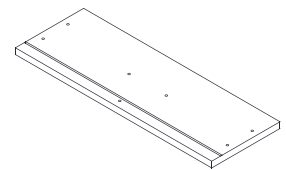

㉕ x9

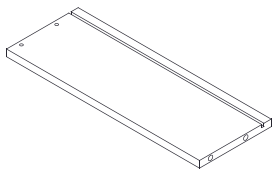

㉖ x9

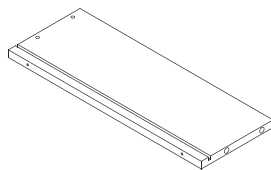

㉗ x9

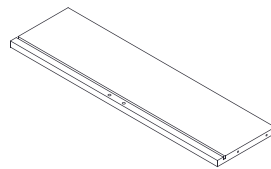

㉘ x9

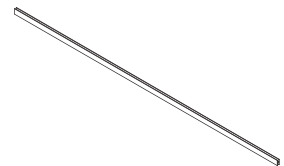

㉙

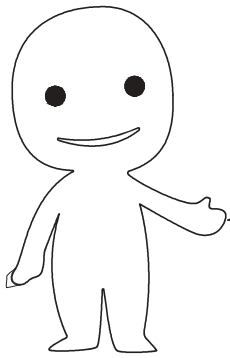

Please prepare the following tools

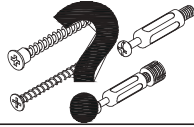
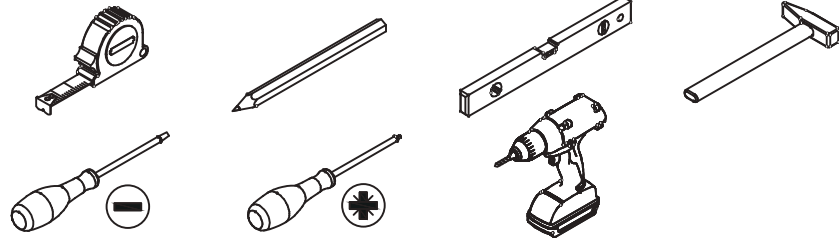

When installing, please carefully confirm whether each screw corresponds to the manual, accessories with similar shapes can be distinguished by size

Tips: The number after “+” represents the spare hardware.

A x 136



∅ 15 x 9.5 mm

B x 76

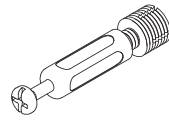

∅ 7 x 40 mm

C x 26

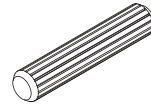

∅ 8 X 40 mm

D x 142

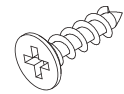

∅ 3.5 x 12 mm

E x 12

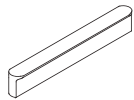

F x 24

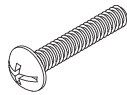

∅ 4 x 18 mm

G x 8

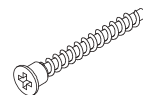

∅ 5 x 40 mm

H x 12

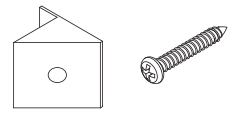

H-1 H-2

I x 72

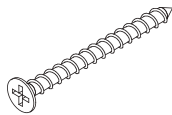

∅ 4 x 35 mm

J x 136



K x 60

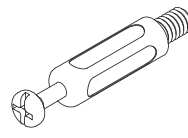

∅ 7 x 40 mm

L x 6

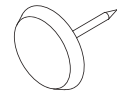

M x 2

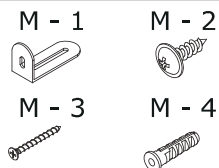

N x 1

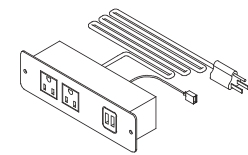

O x 1

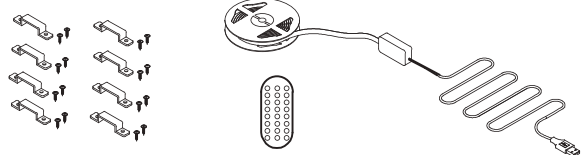

X11

350mm

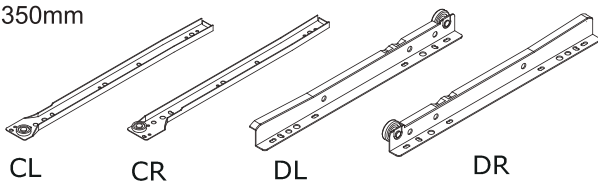

P X 4



∅ 4 x 12 mm

+2

SPARE BAG

X1

250mm

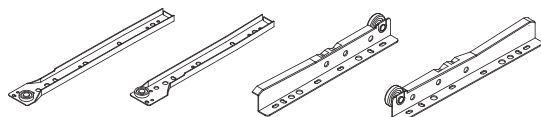

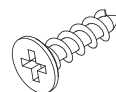

Q x 2

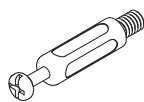
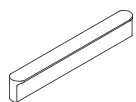

∅ 3.5 x 12 mm

1

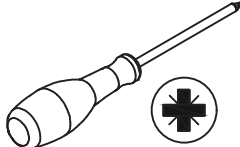
<p>K x 60</p>  <p>Ø7 x 40 mm</p>	<p>E x 12</p> 	<p>F x 24</p>  <p>Ø4 x 18 mm</p>	
---	---	---	---

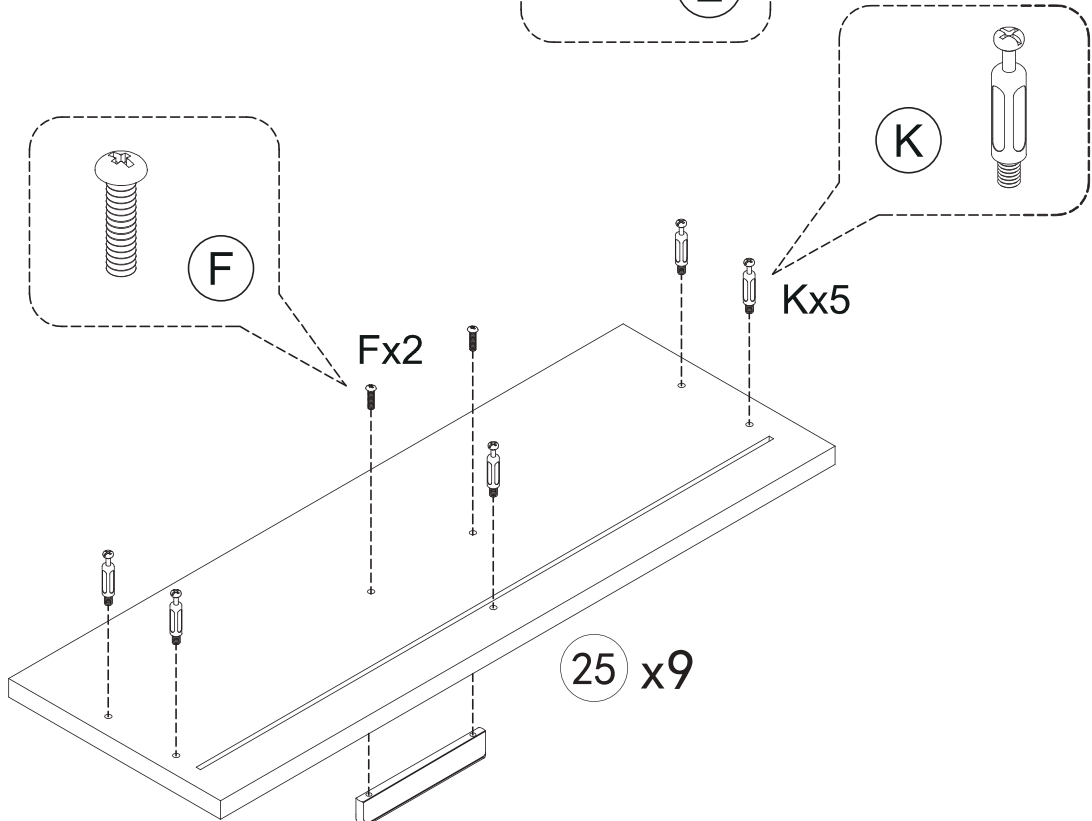
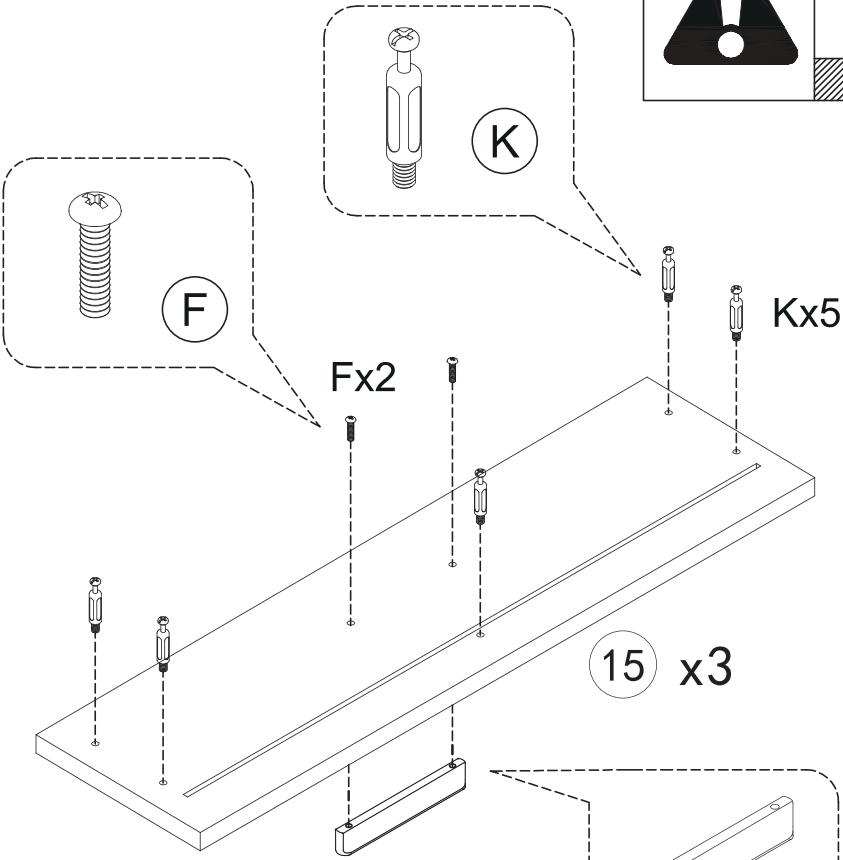
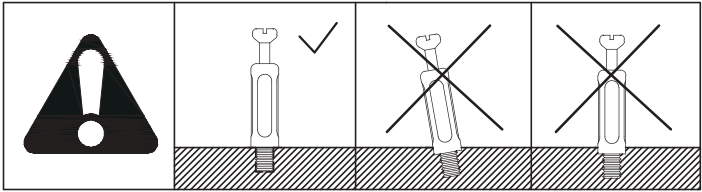

2

1 x 12



Ø4 x 35 mm

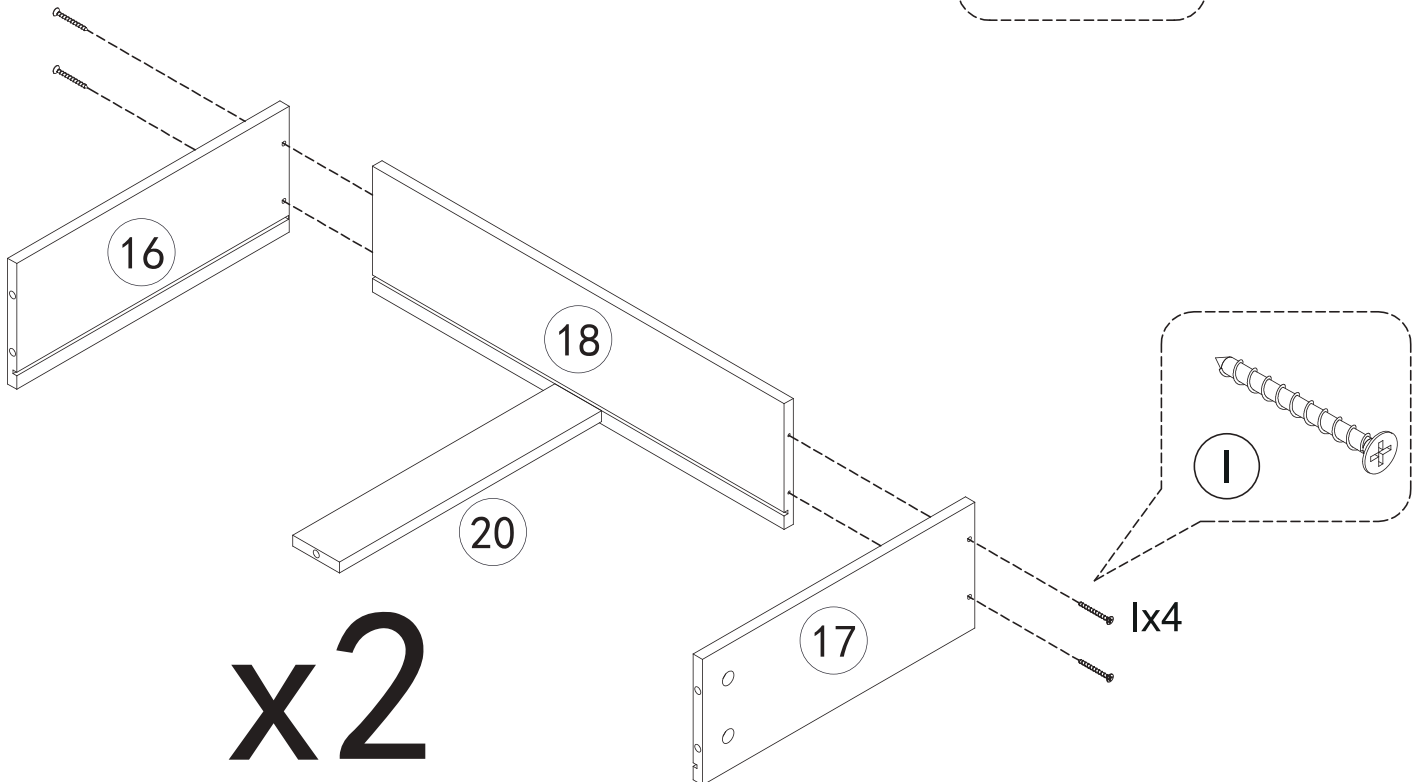
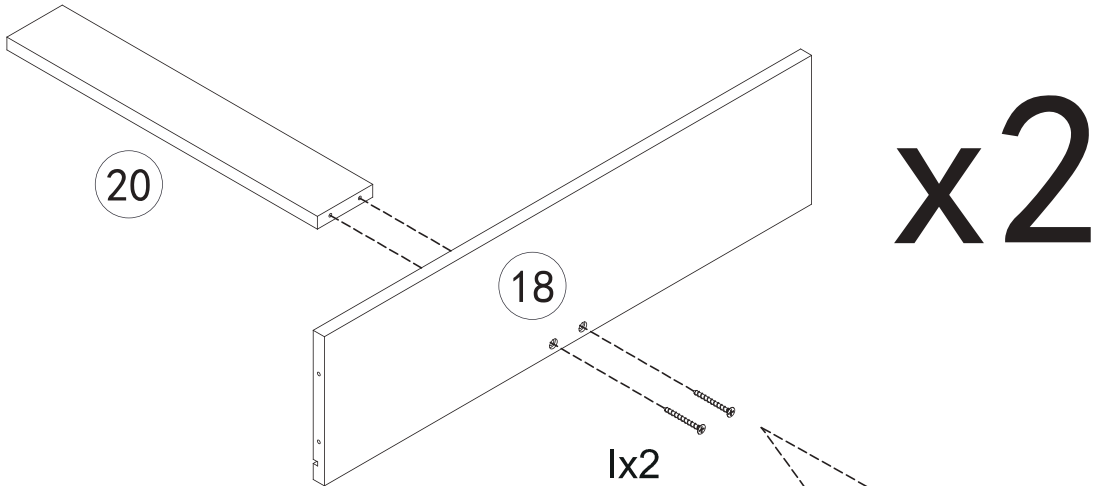
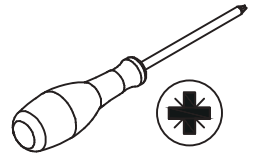

3

1 x 6



Ø4 x 35 mm

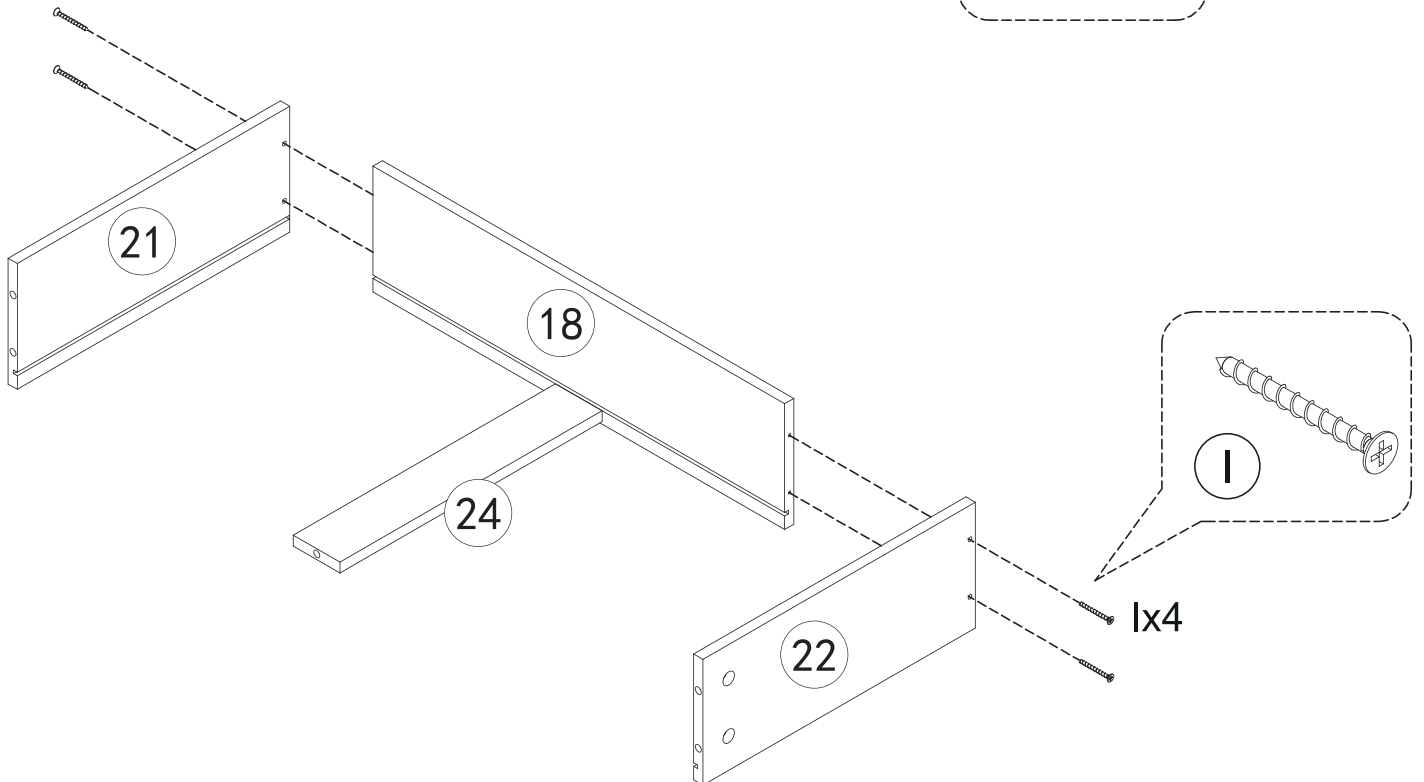
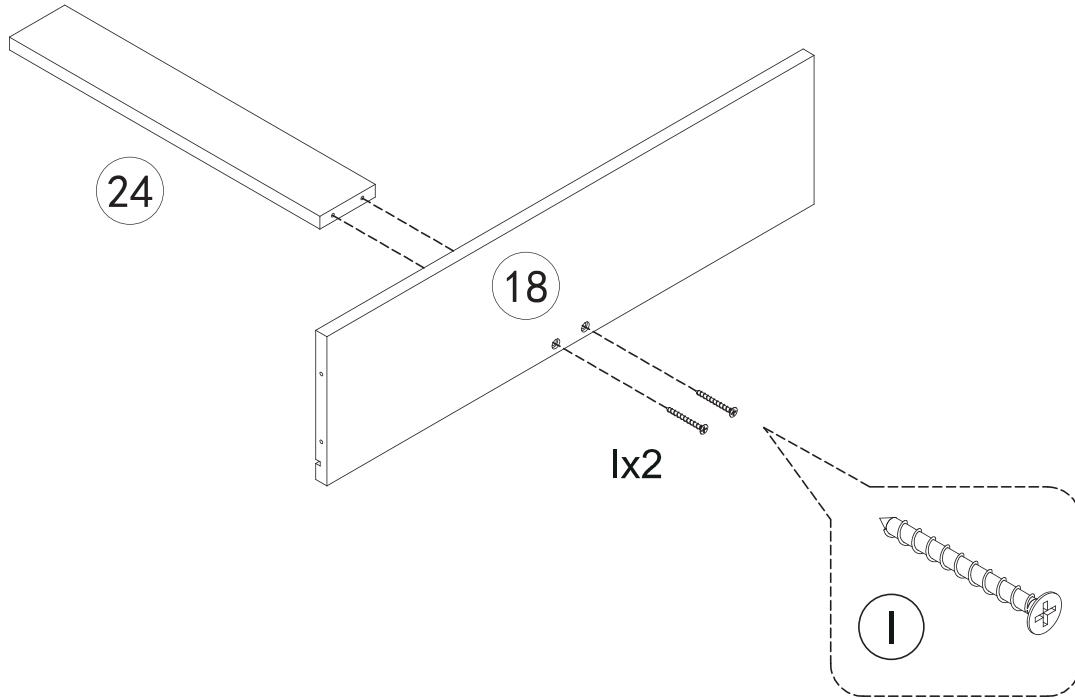
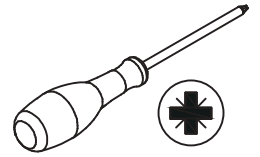

4

I x 54
Ø4 x 35 mm

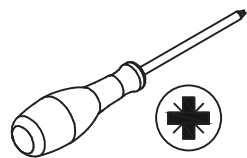

x9

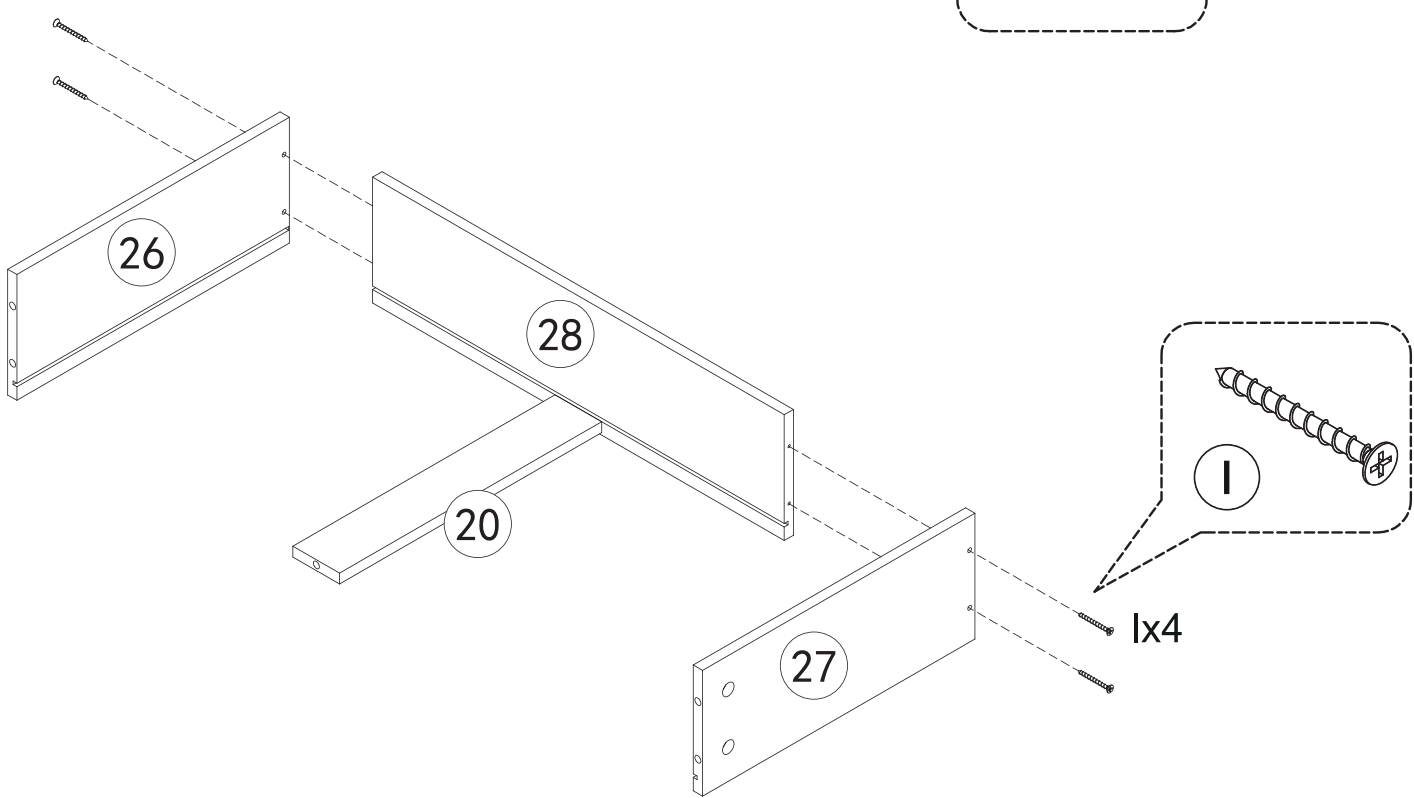
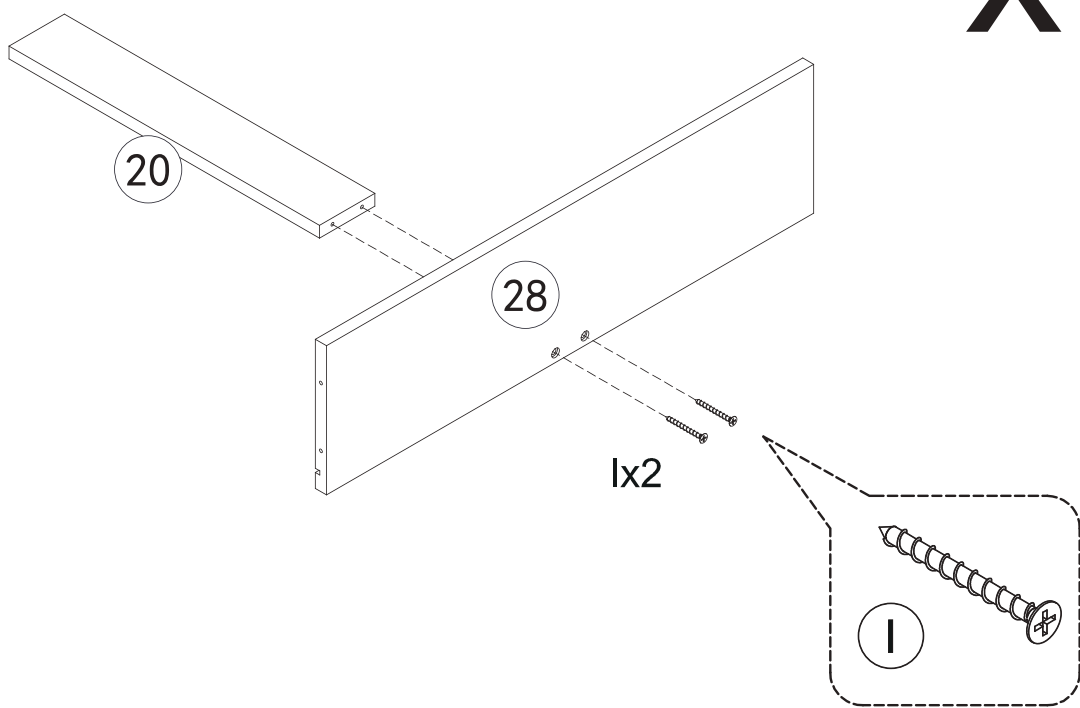

5

A x 15



Ø15 x 9.5 mm

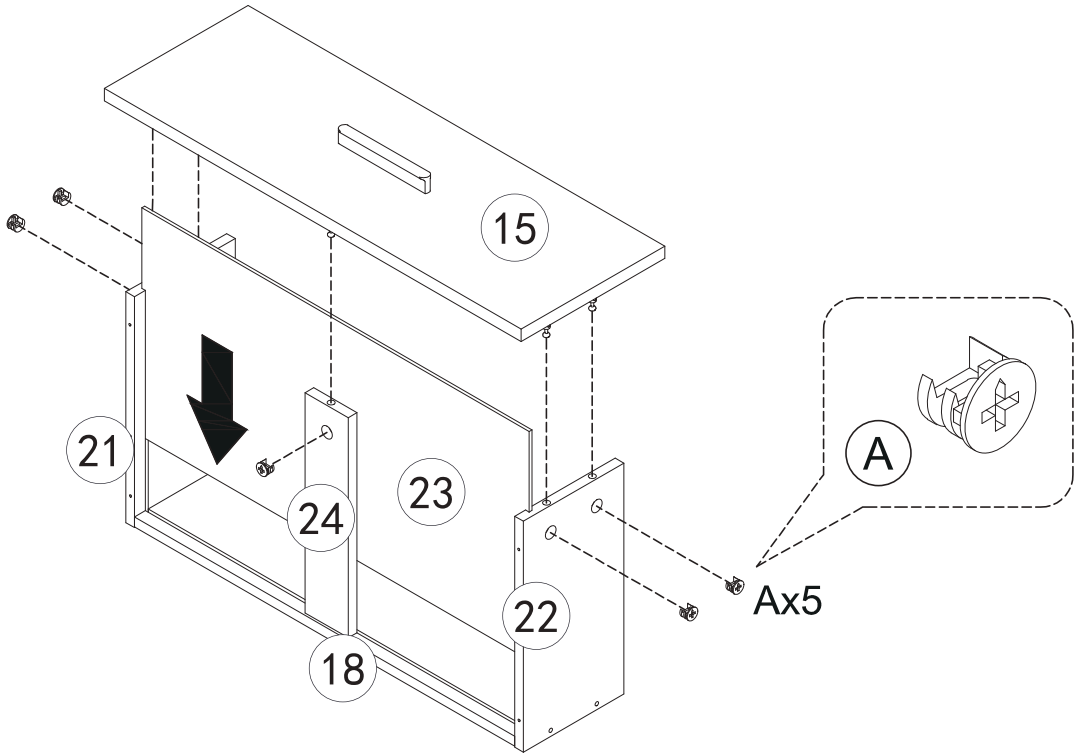
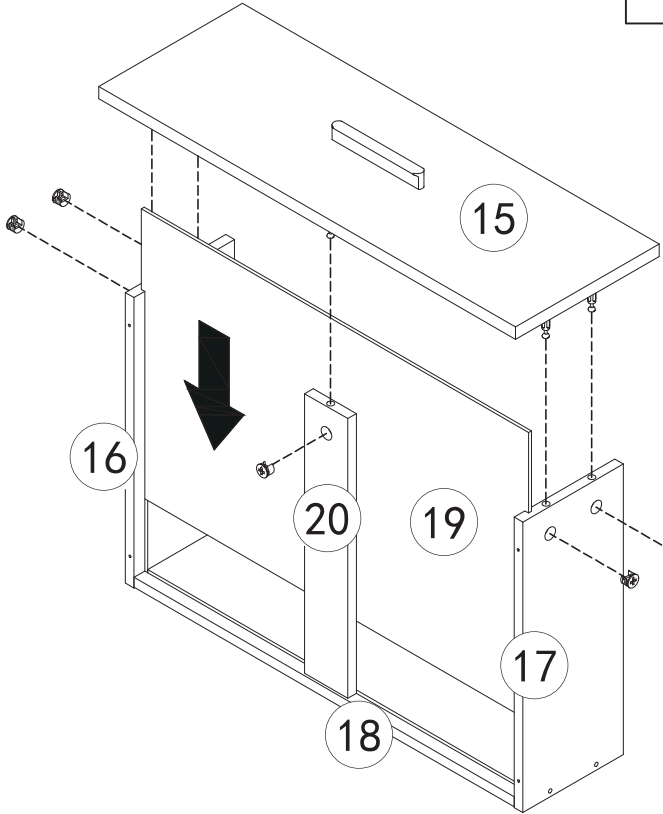
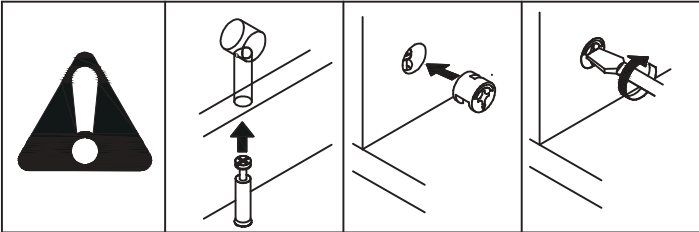
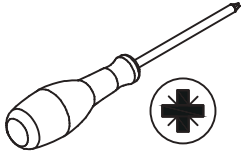

6

A x 45



Ø15 x 9.5 mm

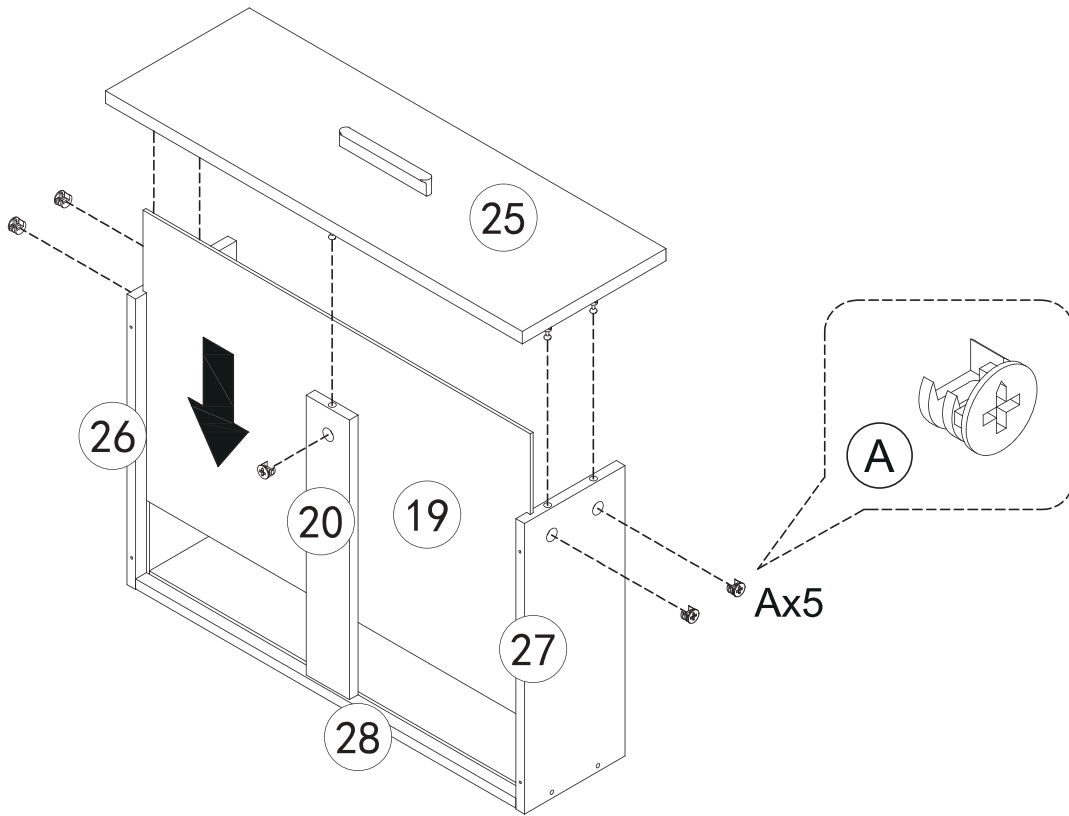
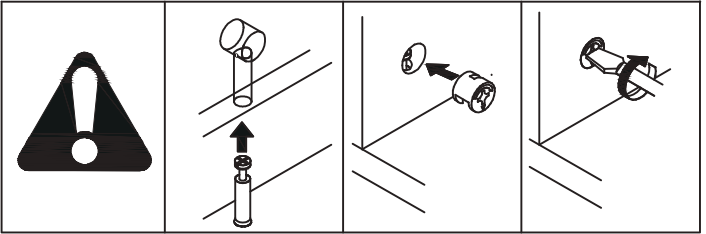
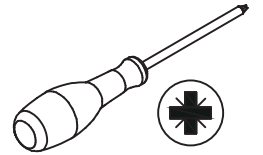

x9

7

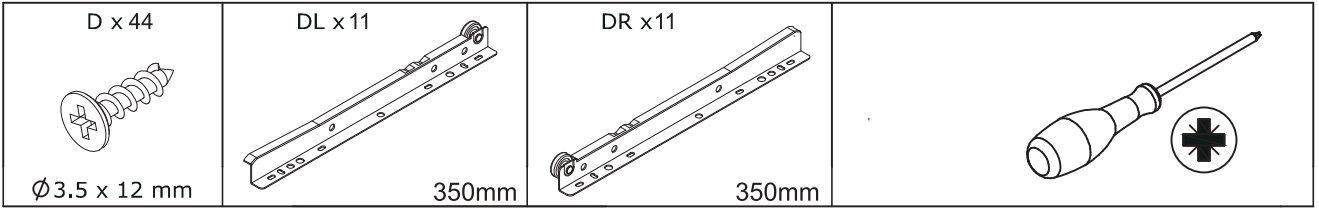

x9

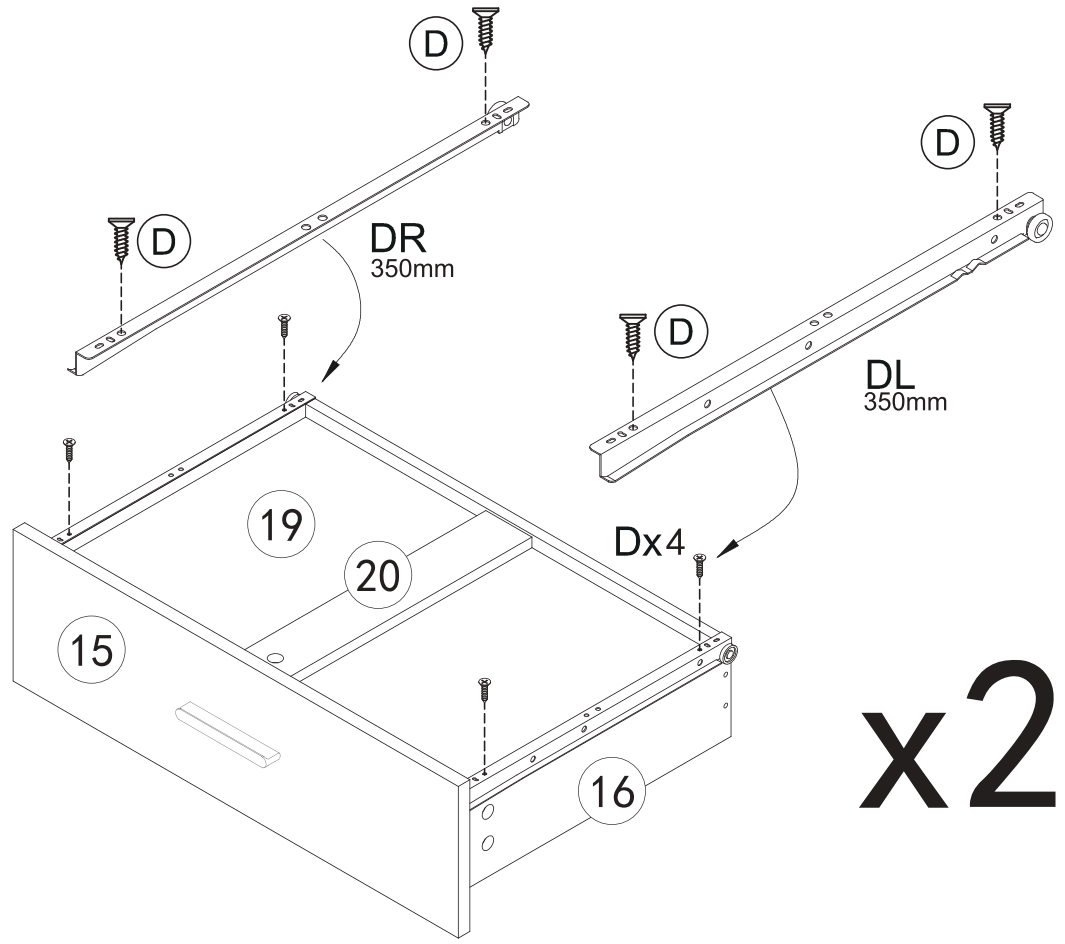
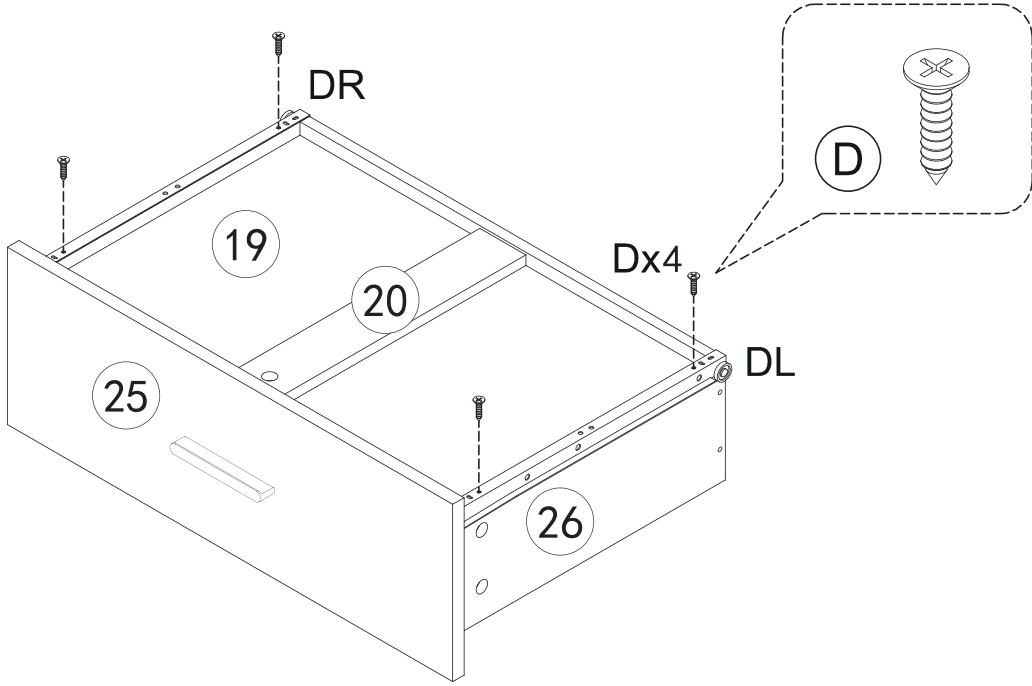

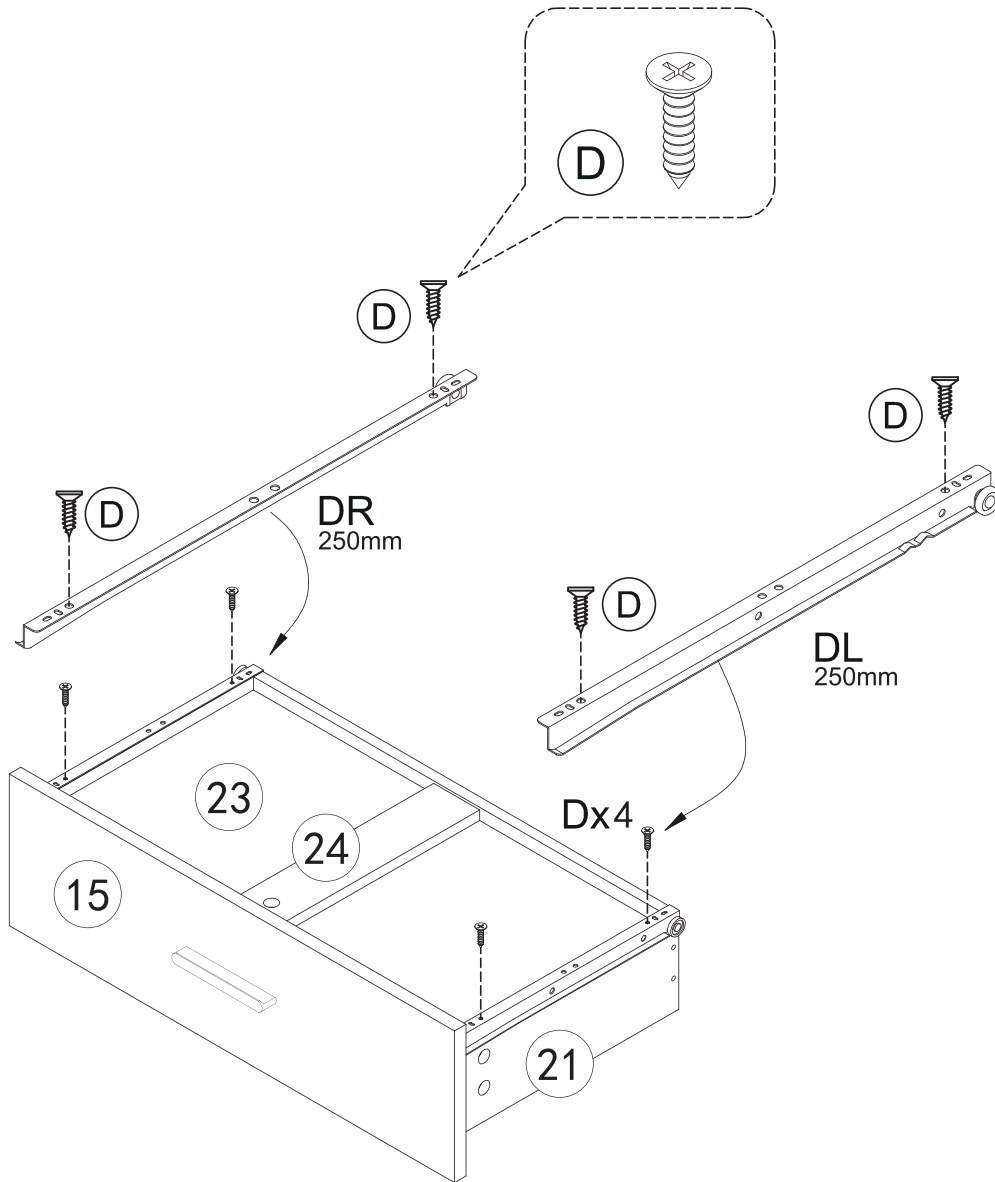
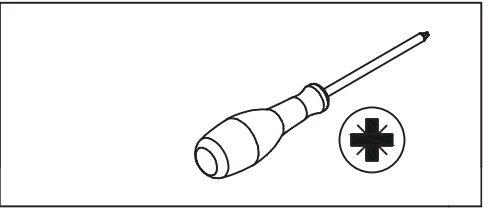
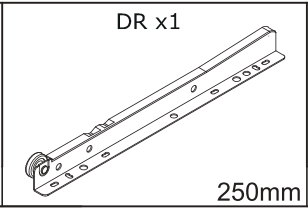
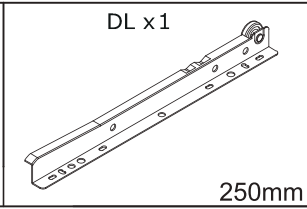
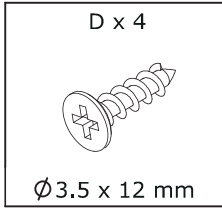

x2

8

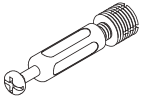

9

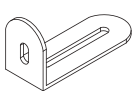
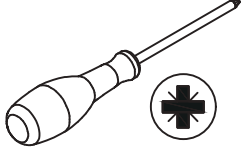
<p>B x 14</p>  <p>Ø7 x 40 mm</p>	<p>M x 1</p> <p>M - 2 x 2</p>  <p>Ø3 5 x 12 mm</p> <p>M - 1 x 2</p> 	
---	--	---

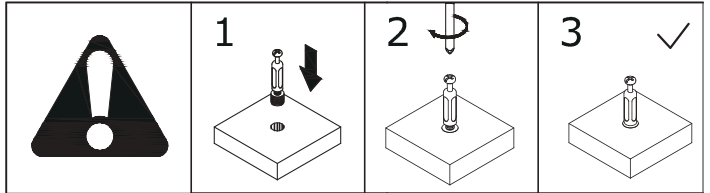
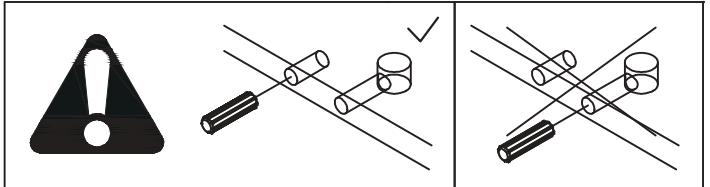

Screw M-2 can not lock too tight

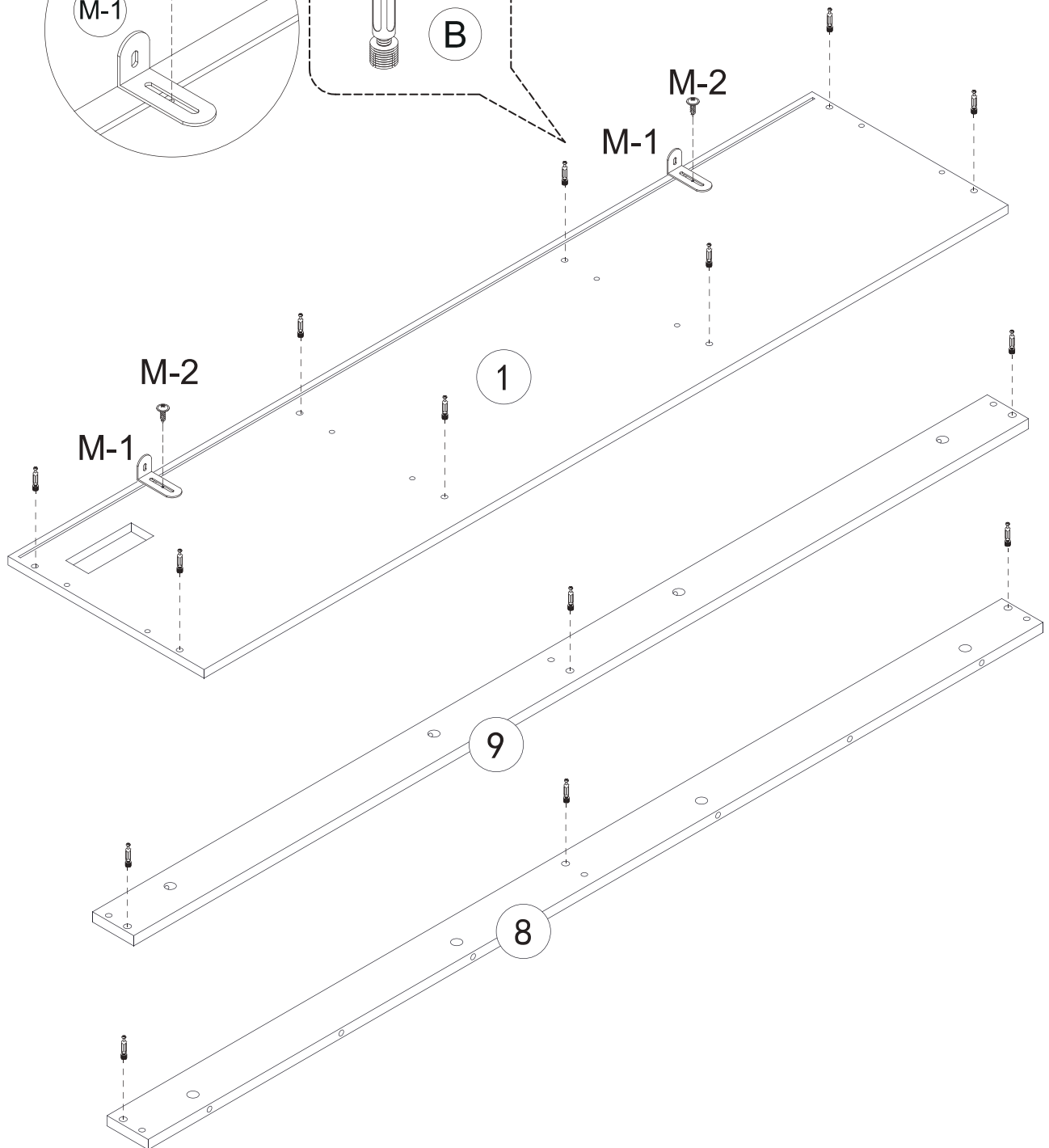
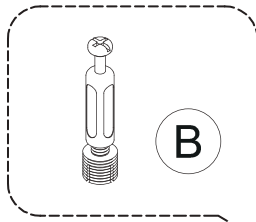
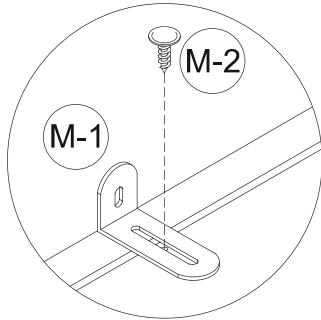

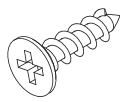
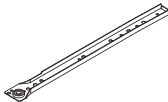
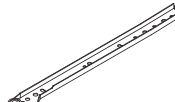
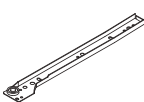
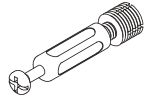
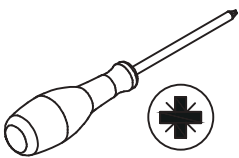

10

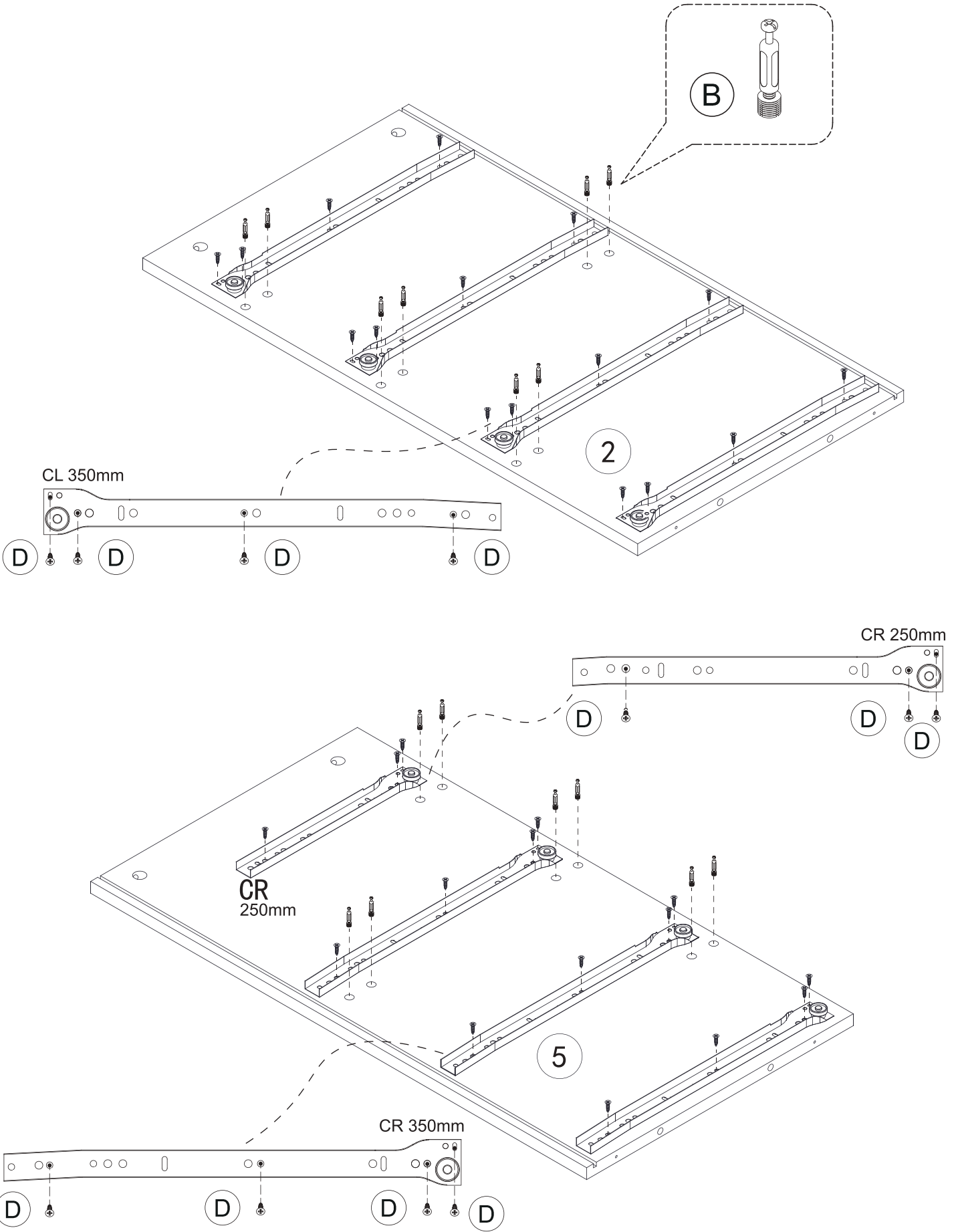
D x 31  Ø 3.5 x 12 mm	CL x 4  350mm	CR x 3  350mm	CR x 1  250mm	B x 16  Ø 7 x 40 mm	 +
--	--	--	--	--	--

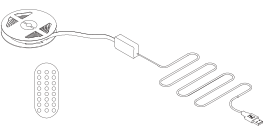
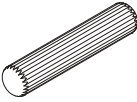
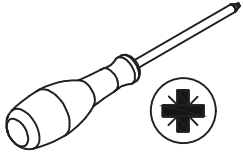

13

<p>A x 6</p>  <p>Ø 15 x 9.5mm</p>	<p>O x 1</p> 	<p>C x 6</p>  <p>Ø 8 X40mm</p>	
--	--	--	--

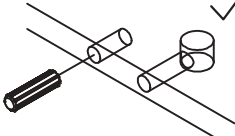
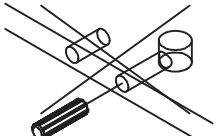
		
---	---	---

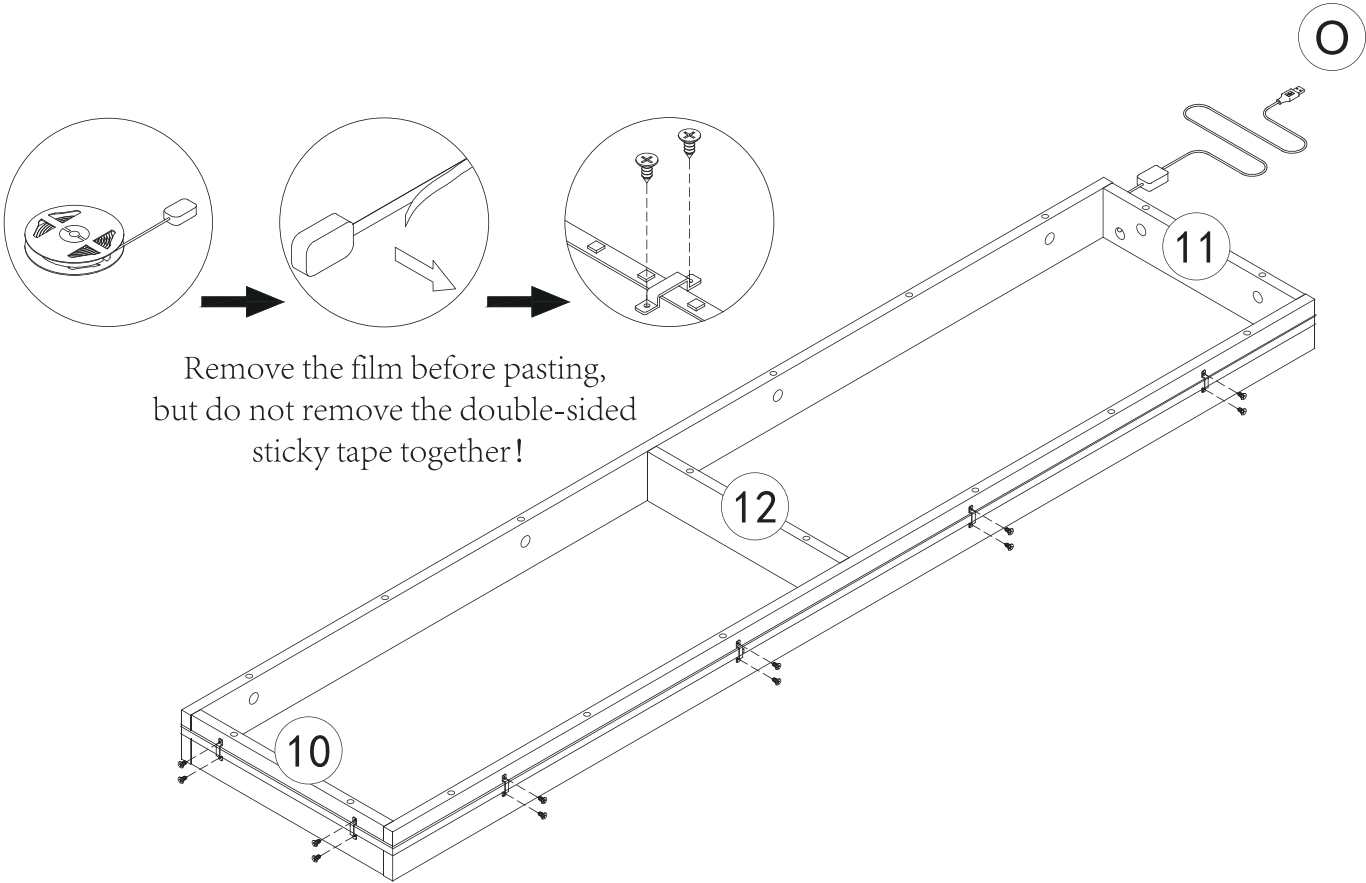
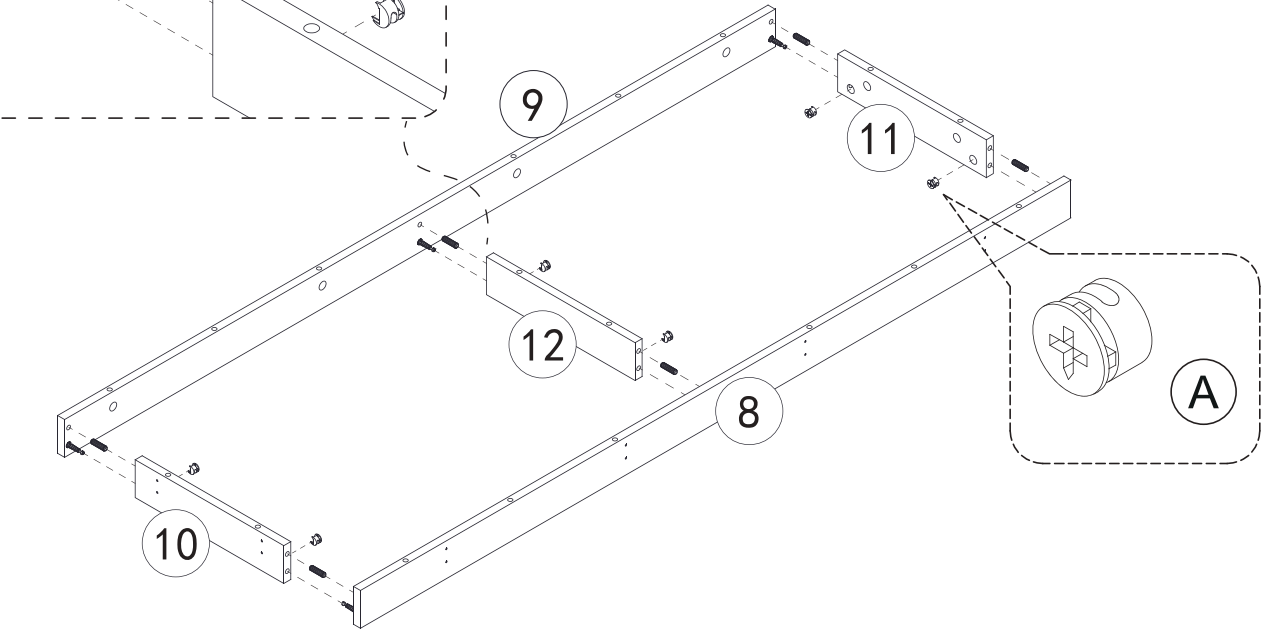
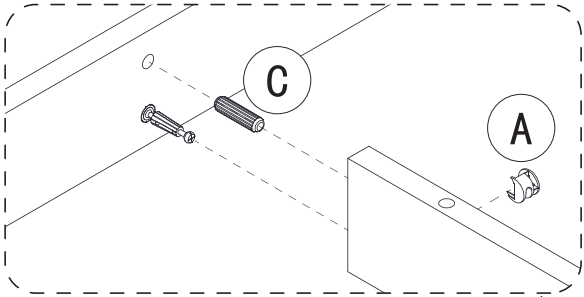

Remove the film before pasting,
but do not remove the double-sided
sticky tape together!

14

A x 48



Ø15 x 9.5 mm

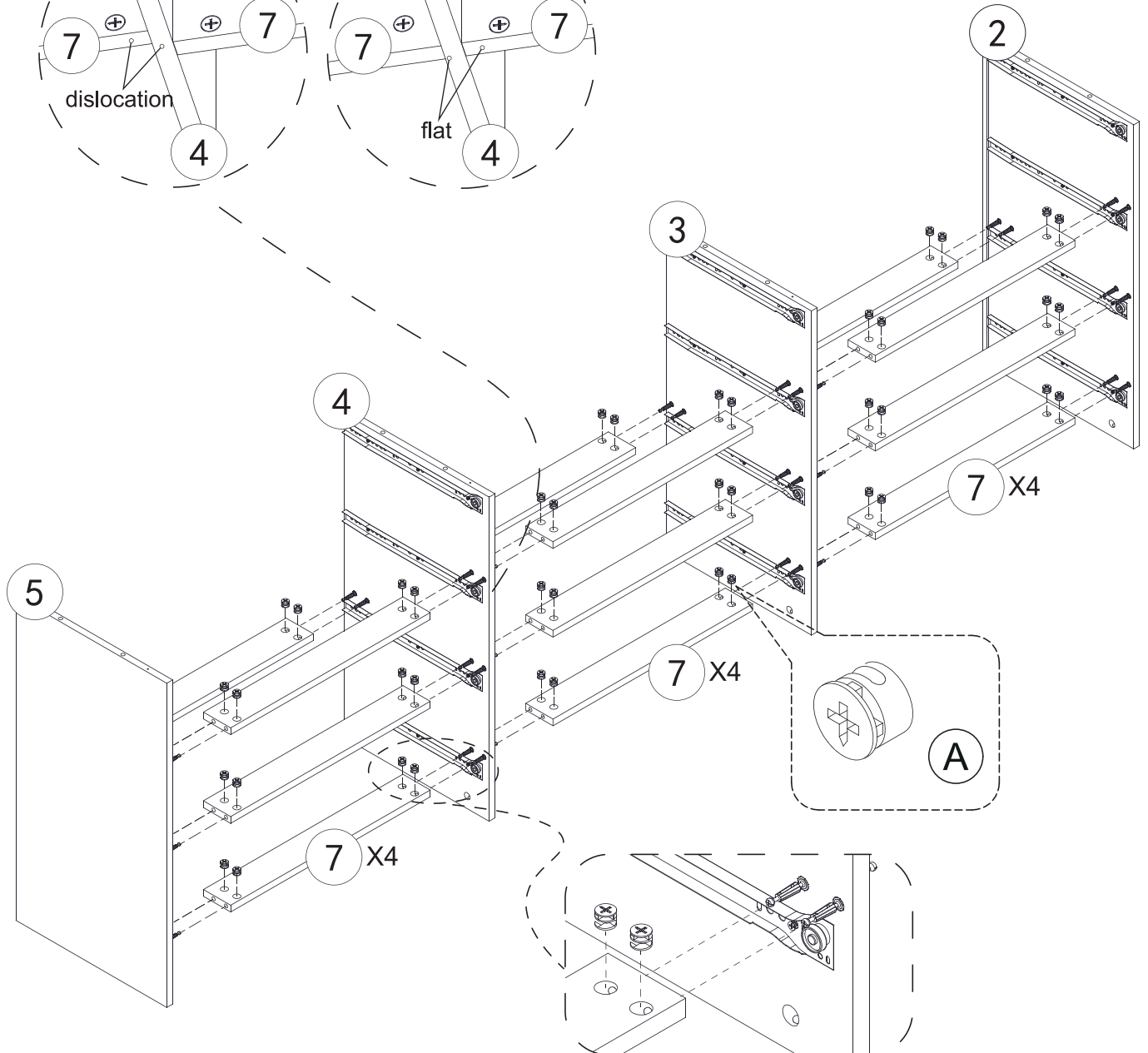
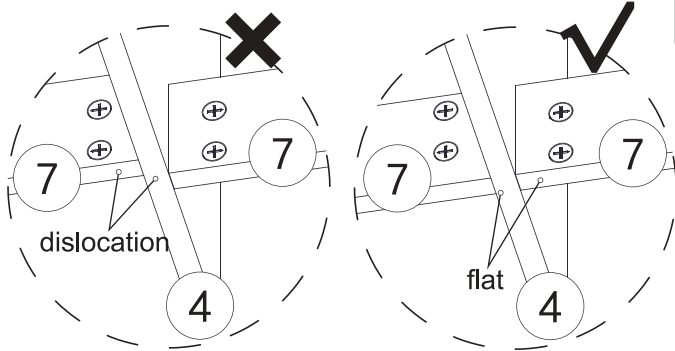
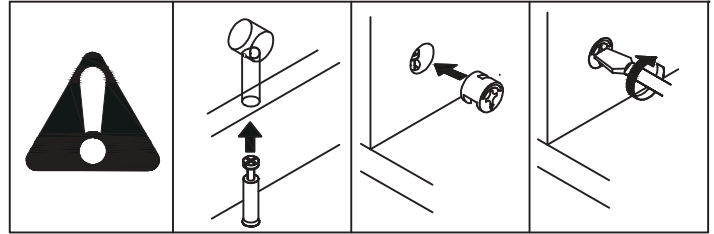
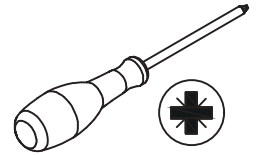

15

<p>C x 4</p>  <p>Ø 8 X40 mm</p>	<p>B x 14</p>  <p>Ø7 x 40 mm</p>	
--	---	--

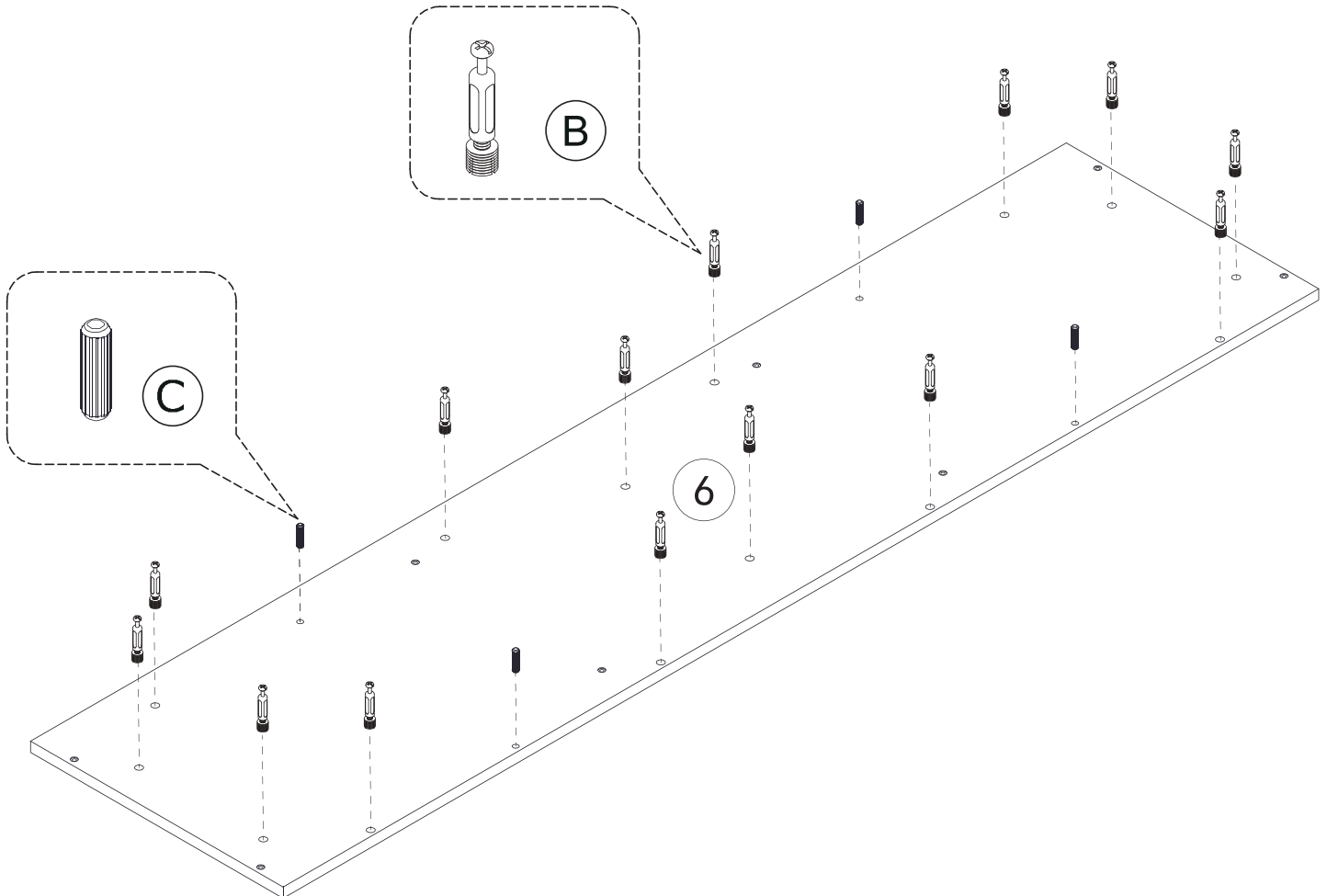
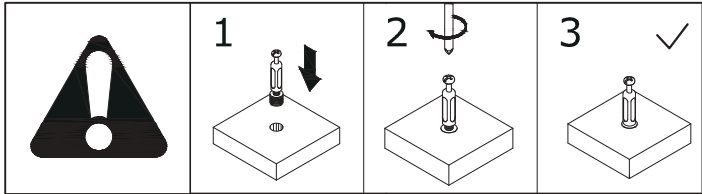
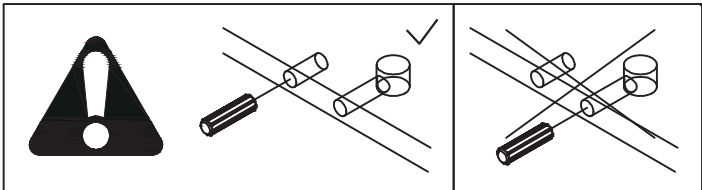

16

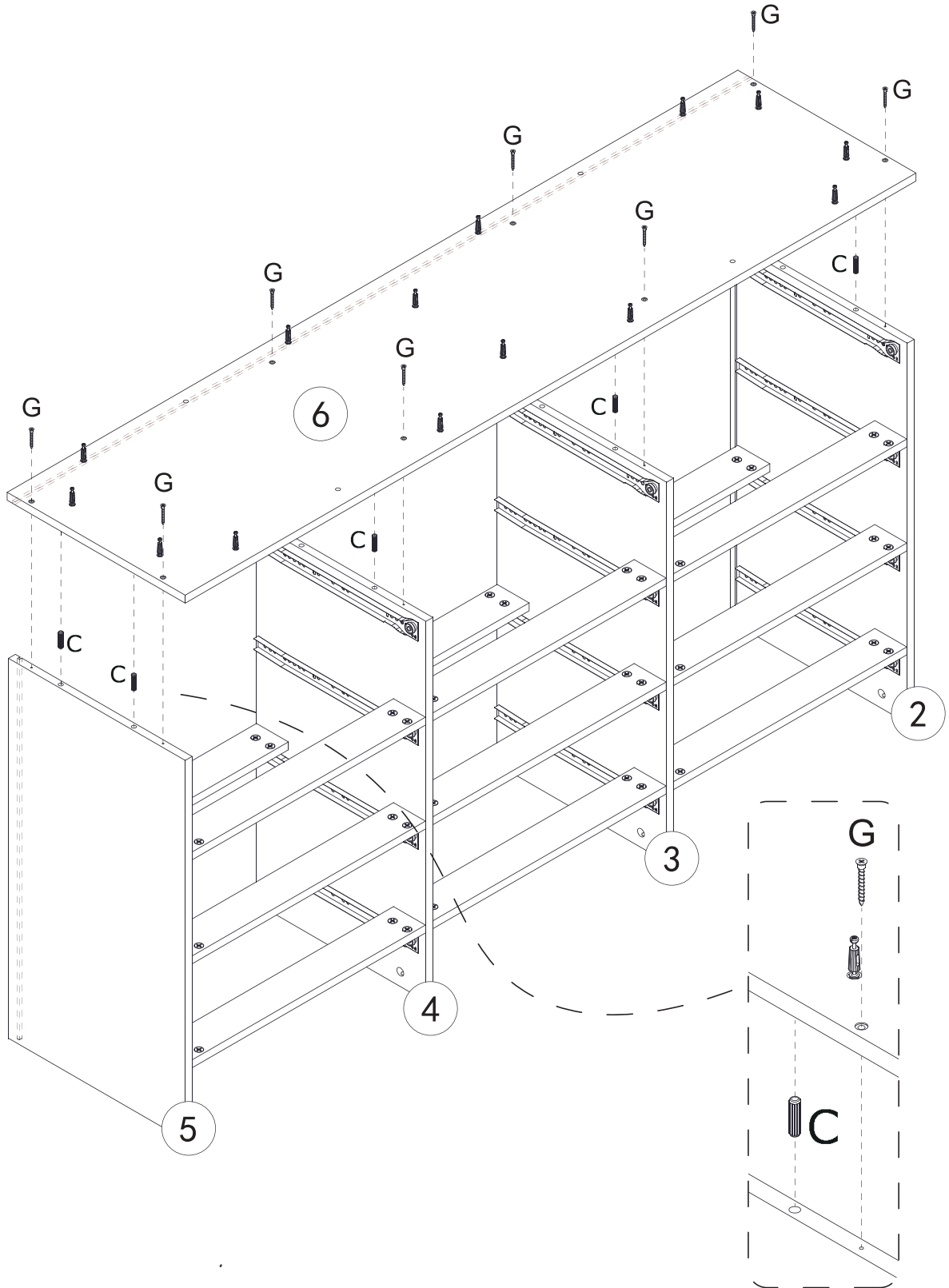
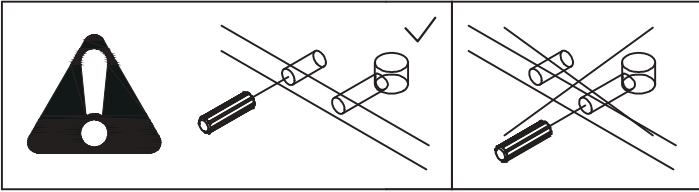
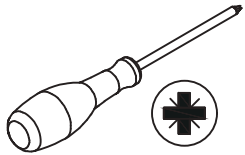
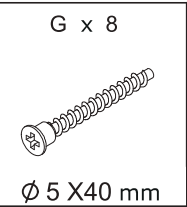
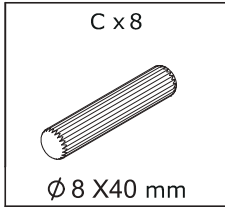

17

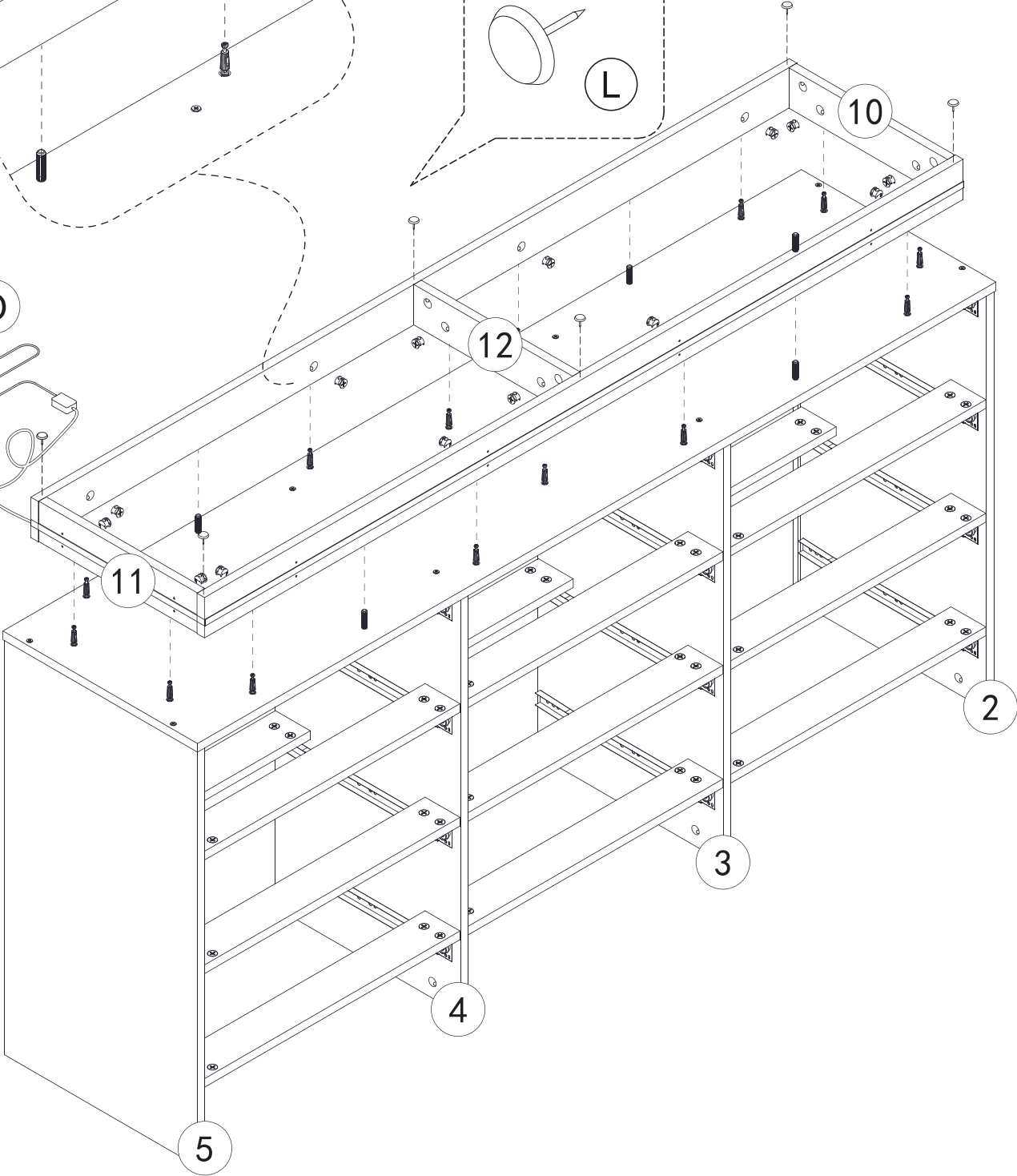
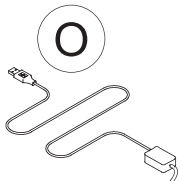
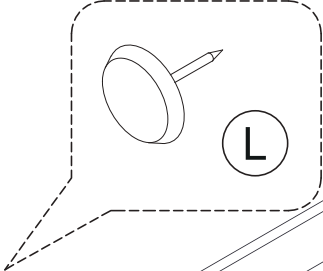
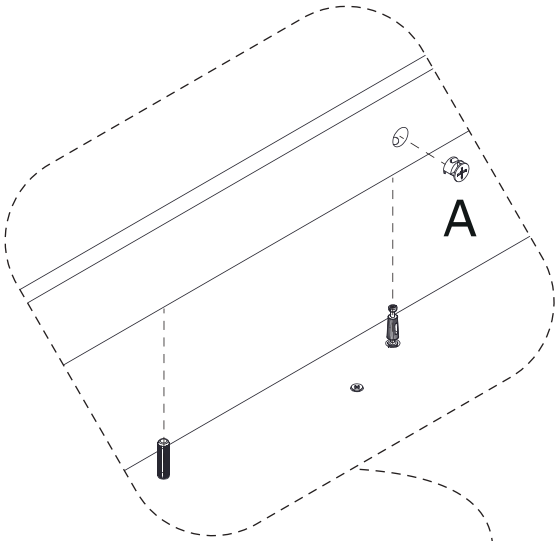
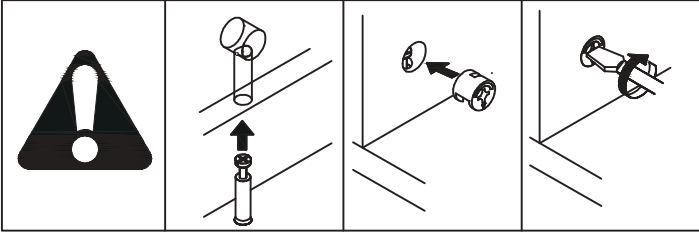
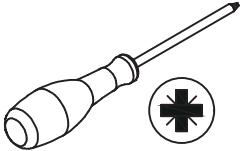
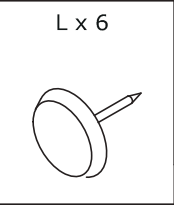
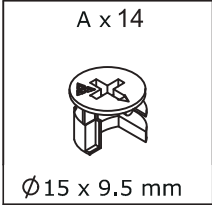

18

P x 4



Ø 4 X12 mm

Pay attention to the installation direction of the cabinet backboard!

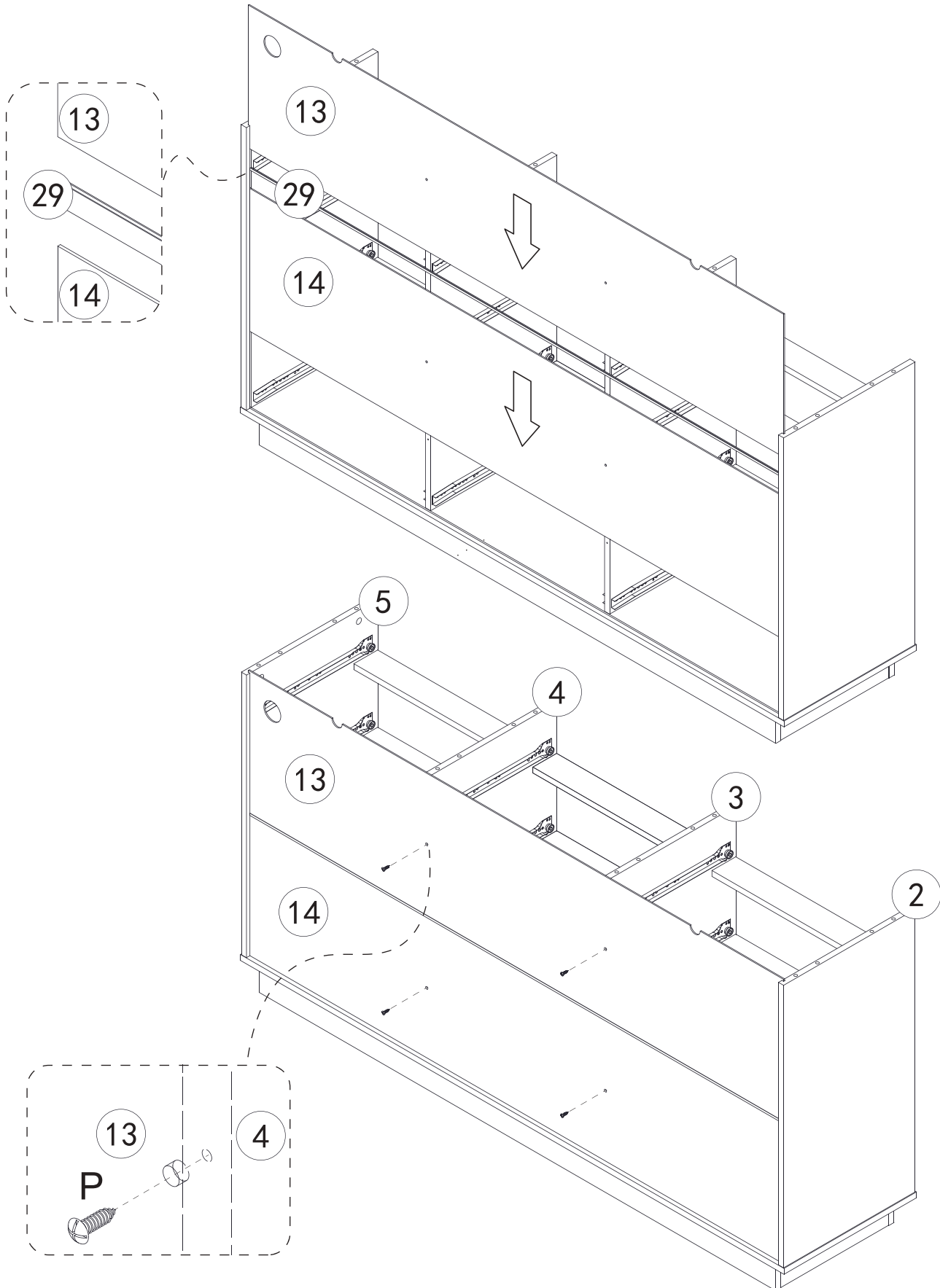

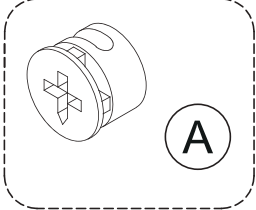
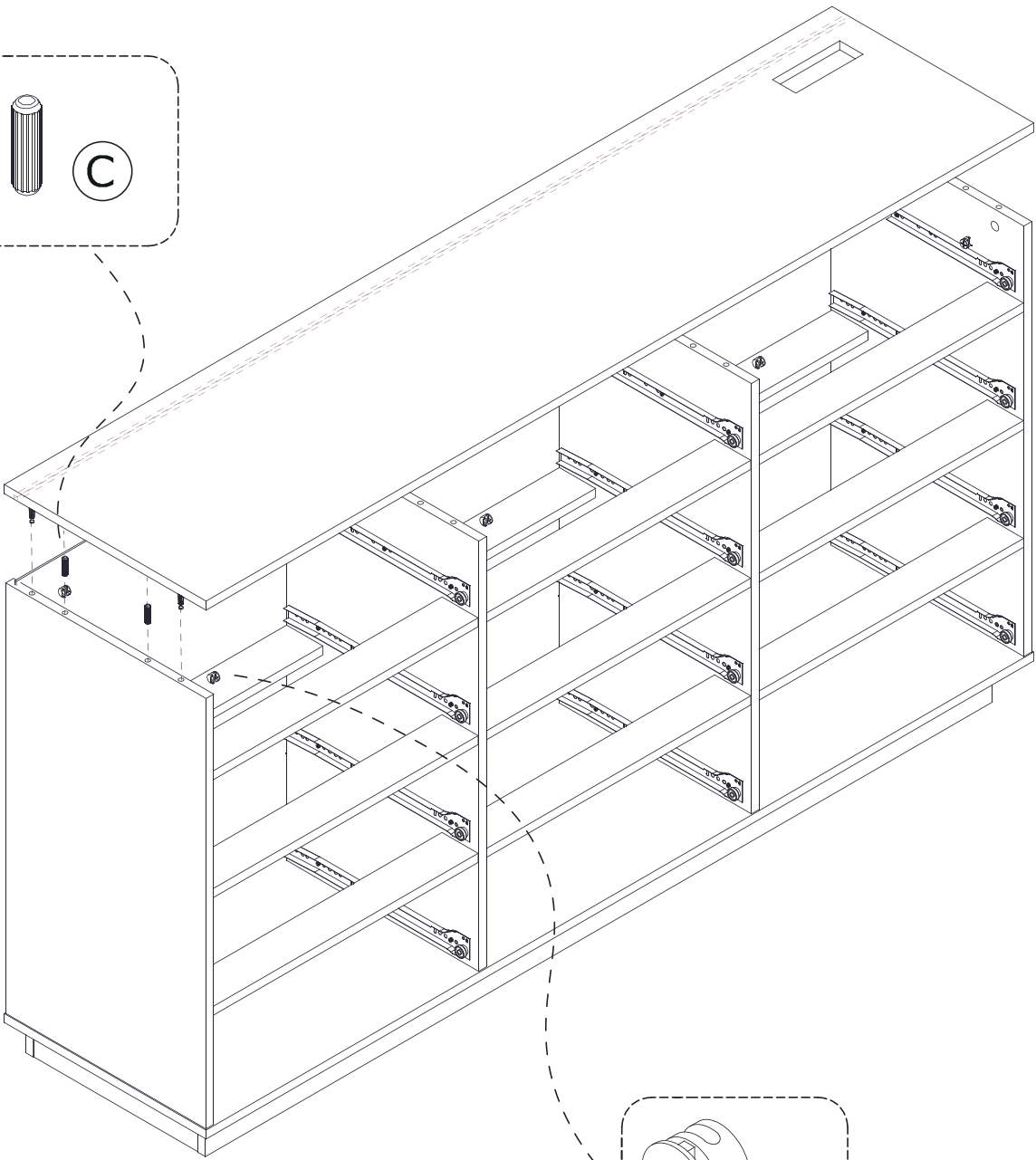
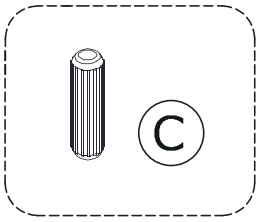

19

<p>A x 8</p>  <p>Ø 15 x 9.5 mm</p>	<p>C x 8</p>  <p>Ø 8 X 40 mm</p>	
---	---	---



20



H x 12

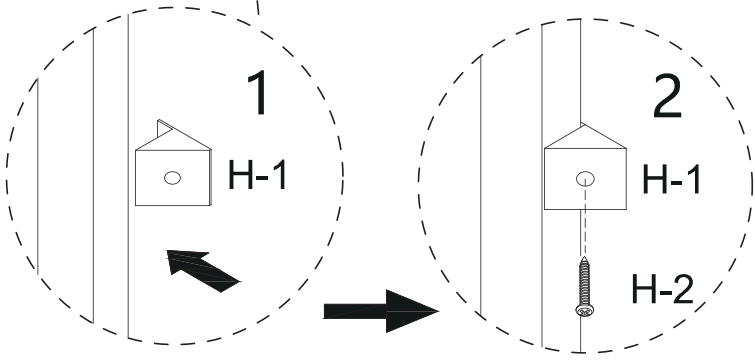
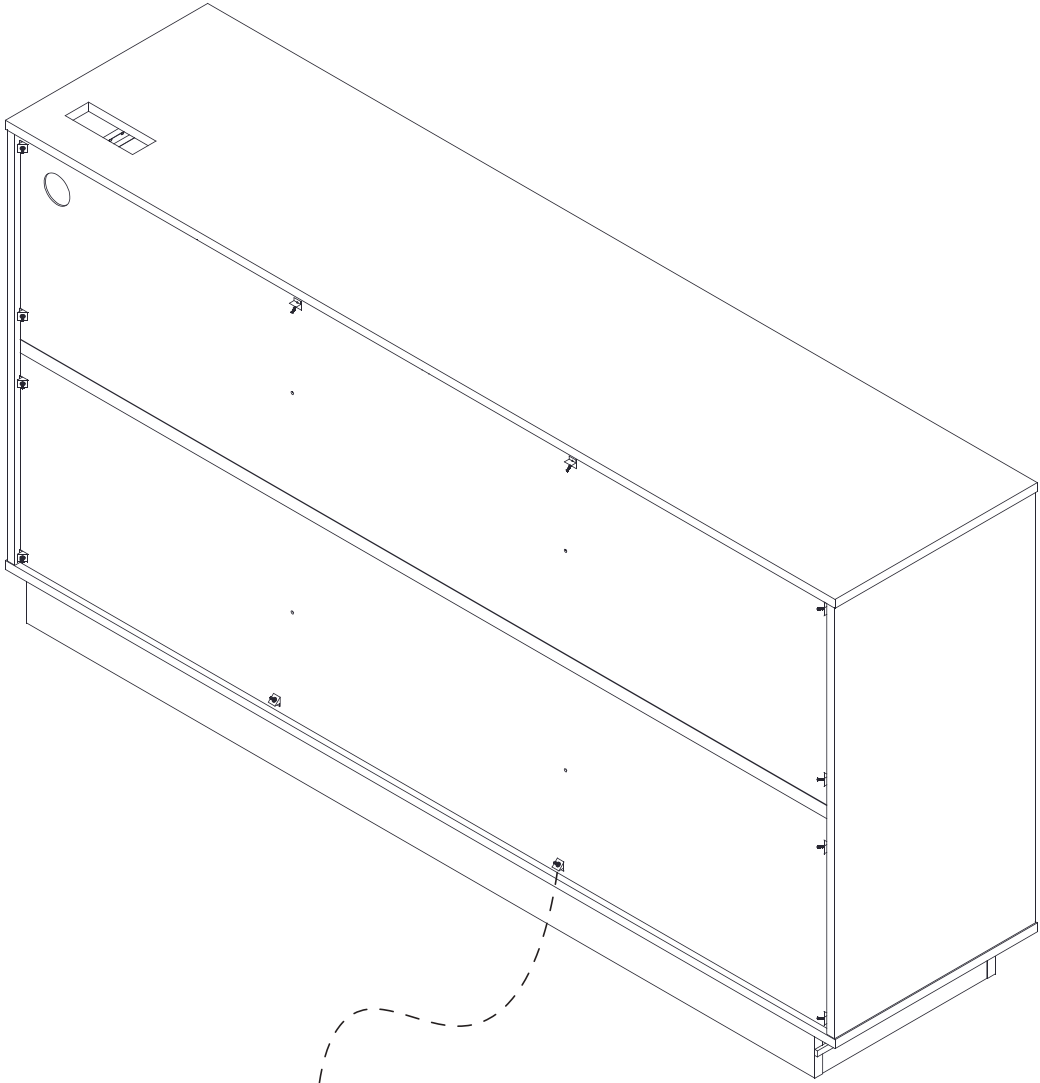
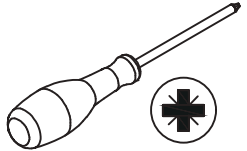

H-1 H-2

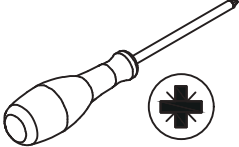

21

<p>Q x 2</p>  <p>Ø3.5 x 12 mm</p>	<p>N x 1</p> 	 
--	--	---

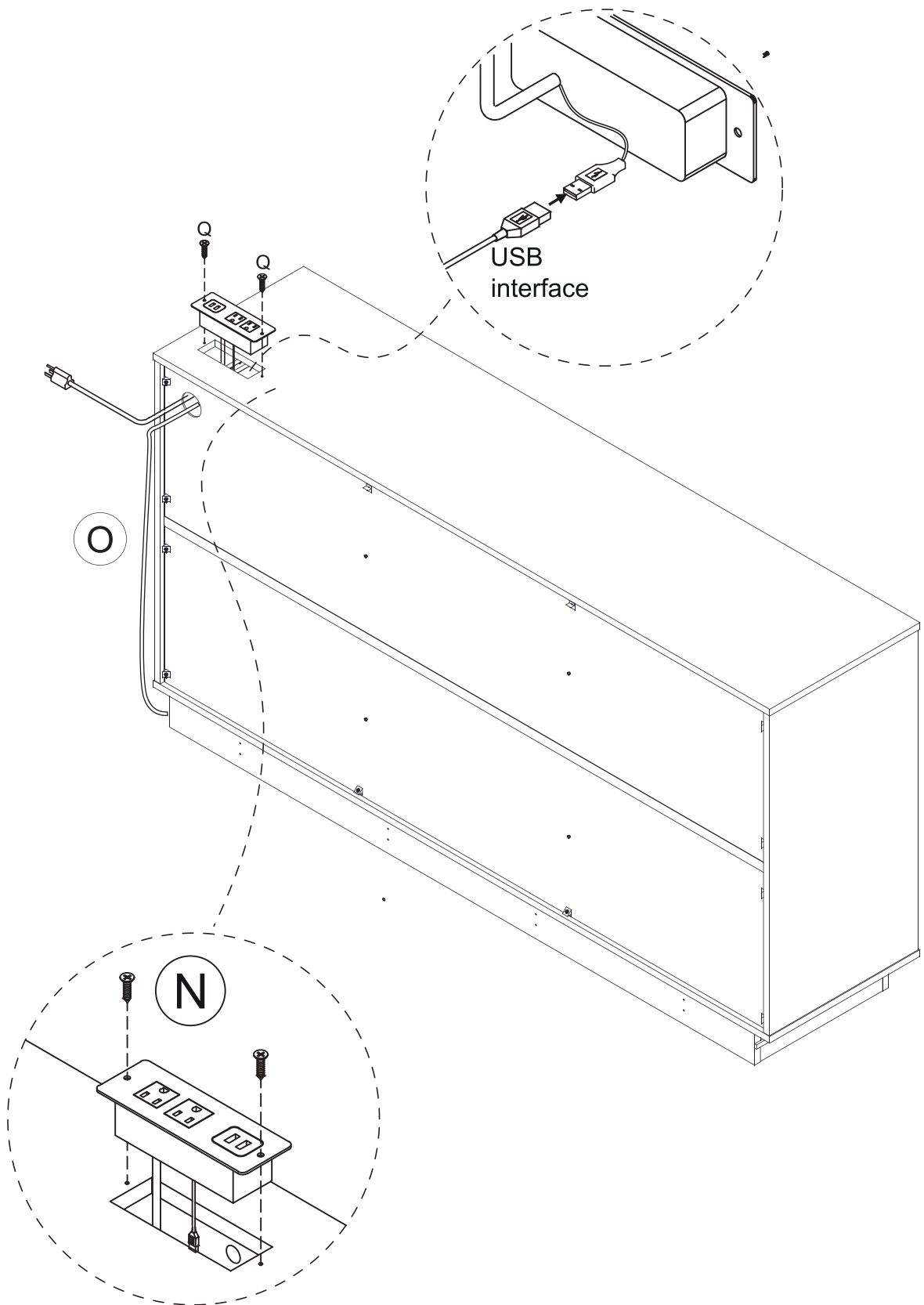

22

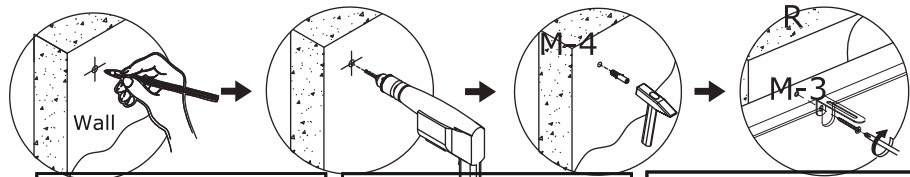

A solid wall	B cavity wall	C solid wood
\varnothing 6mm (1/4)	\varnothing 6mm (1/4)	\varnothing 3mm (1/8)

⚠ Warning: If you overturn the furniture, it may cause serious or fatal crushing injuries. We have a wall connection device attached, please use it to hold the furniture following these instructions.

1. Mark the corresponding hole positions where you want to place the furniture;
2. Use a impact drill to drill holes and pay attention to avoid wires and water pipes;
3. Knock the expansion pipes into the wall holes;
4. Place the furniture in the corresponding position and tighten the wall connection device with screws, and Lock the M-2 screw tightly.

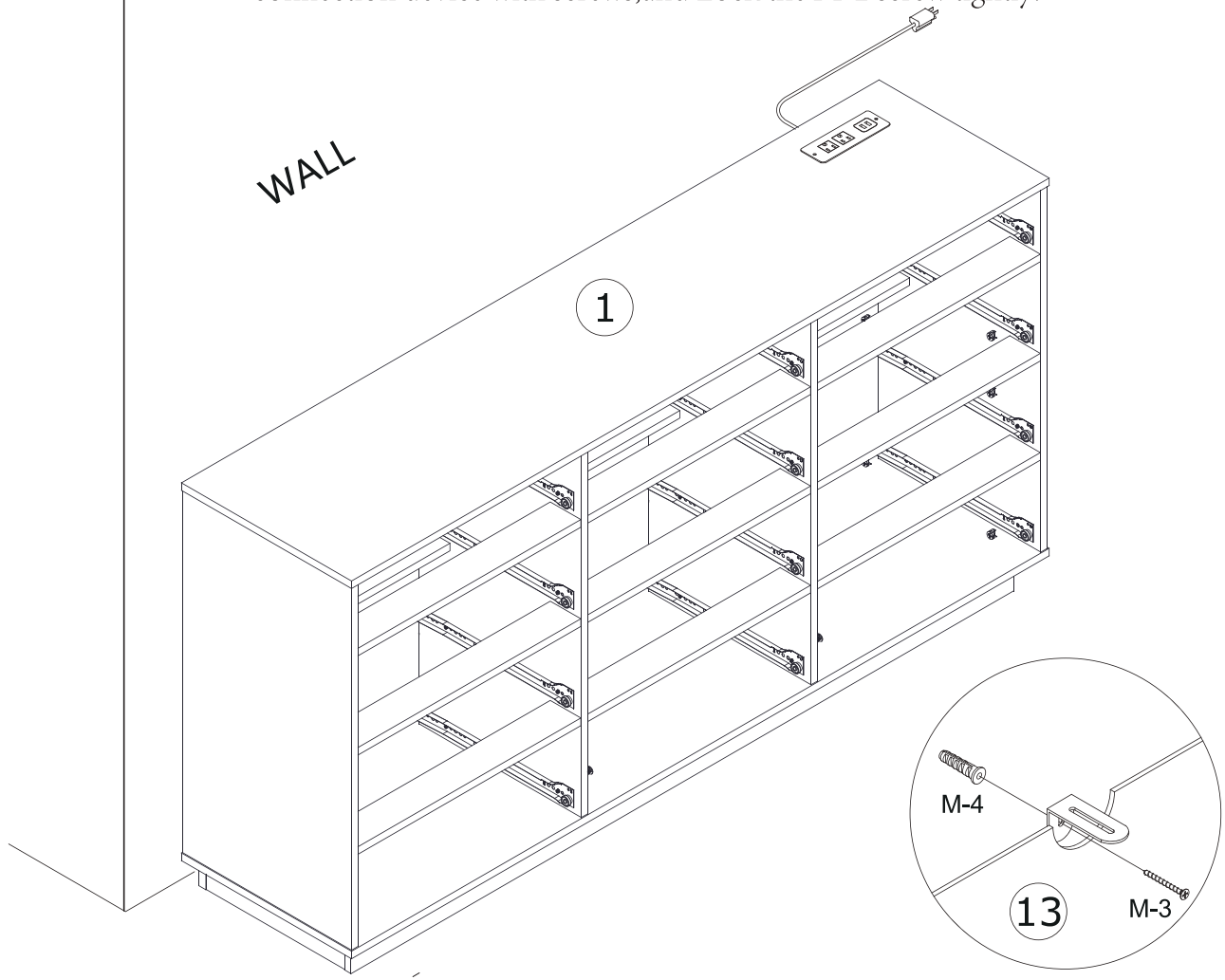

23



Cabinet Slide

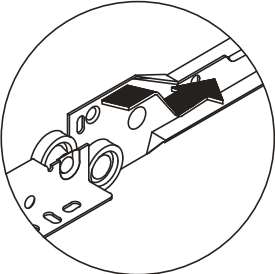

Drawer Slide

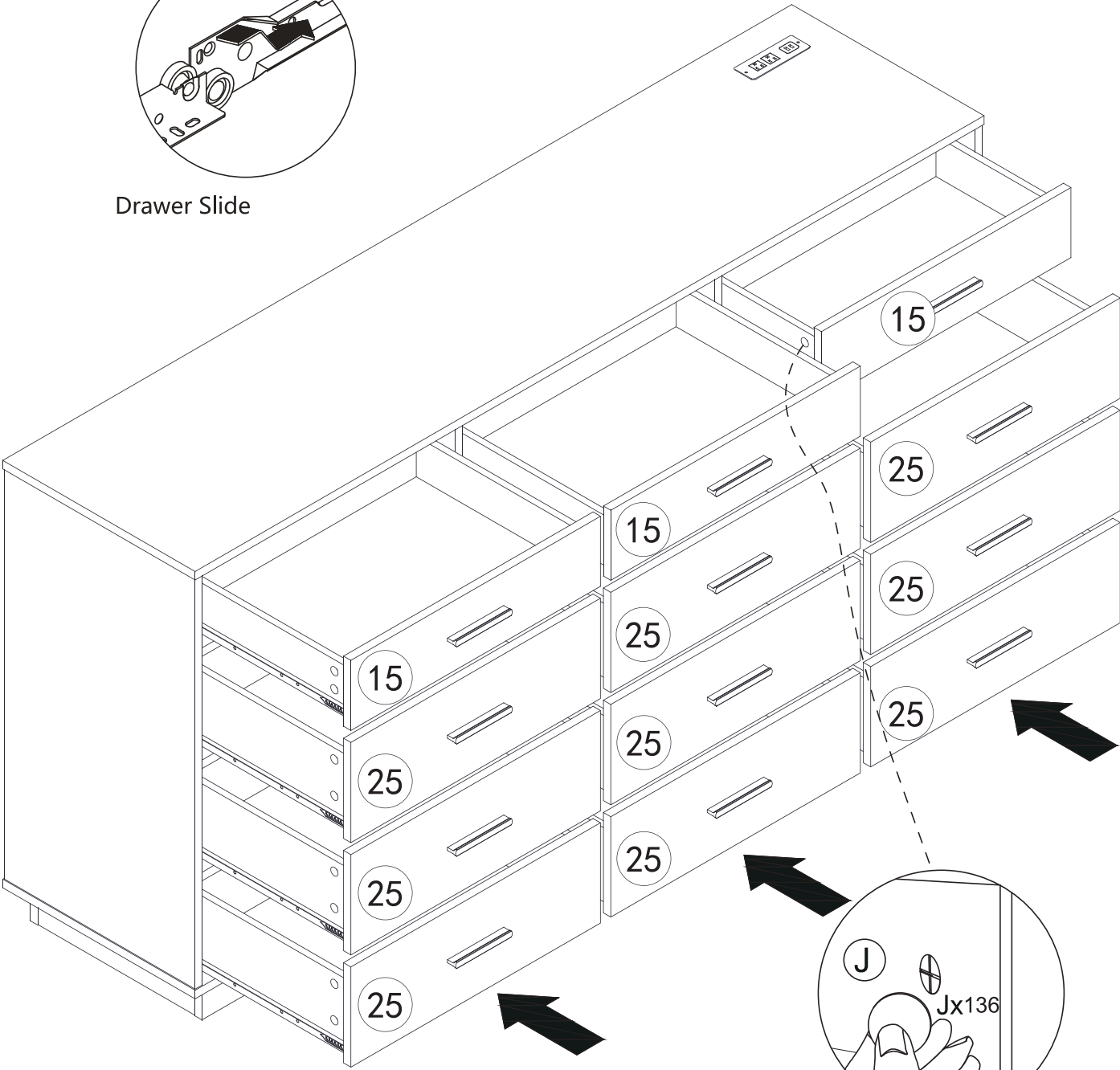

Stick the ring patch J on the lock holes

-LED lamp with effective remote control distance of 5 meters

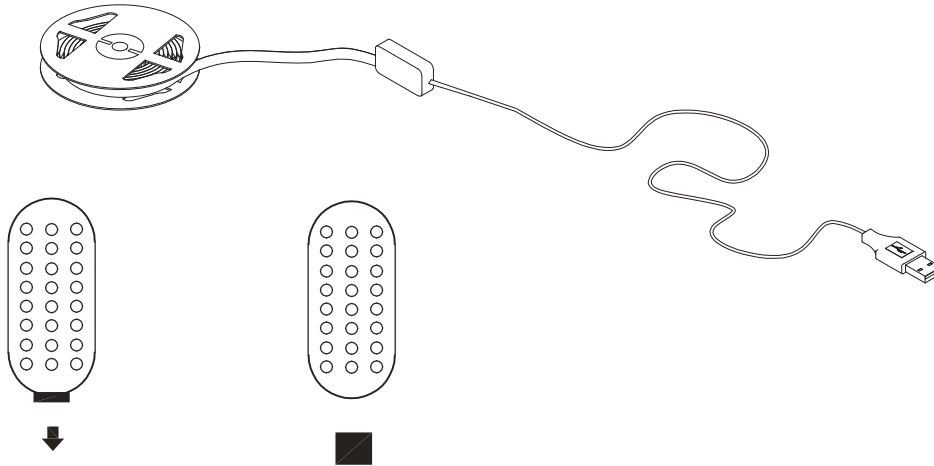

1. Take out the remote control gasket

Remote control mode

	<p>In any state press these two keys to turn on/off the light strip.</p>
	<p>When light is on, press these two keys to reduce-or increase+brightness there are 10 brightness levels for adjustment.</p>
	<p>Press relevant keys to select particular colors</p>
	<p>Press this key to switch static colors There are 16 kinds for chosen.</p>

APP PROGRAM USAGE



Scan two-dimensional code download APP

- ① Connect LED color strip and controller, power on controller
- ② Scan two-dimensional code download APP:

- ③ Start APP, search and connect controller
- ④ Enjoy the Bluetooth wireless control experience

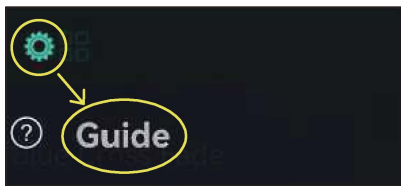

Notes:
detailed operating instructions,
enter the menu "Guide":

- Product Paramters:
- Bluetooth: BLEV4.2
 - Input Voltage:4.5~26V
 - Working Temp:-25~75°C
 - Size:43*22*11mm
 - Weight:30g
 - Max Power:144W(24V)

LED mobile phone Bluetooth controllerProduct Features

- LED Bluetooth controller is directly via mobilephone control remote distance can reach 20m without the need to set up, easy to connect open the software within 5 seconds you can automatically connect the controller
 - Flow the rhythm of the music changes
 - Group control
 - Brightness, speed addition and subtraction
 - Maximum can be 10 meters RGB(W) strip
 - The software shows that the text is based onthe language of the mobile phone set up automatic transformation of Chinese and English
- Animation Effect:
- Colorful gradient
 - All kinds of monochrome, double color gradient
 - All kinds of monochrome, double color,colorfull flashing
 - Colorful jump
 - Follow the thymh of the music chagnes