



OWNER'S GUIDE & SERVICE MANUAL

MARVEL UNDERCOUNTER REFRIGERATION



Model: MPNP415-SS81A

WELCOME

Welcome to the Marvel Experience!

Thank you for choosing our quality American-built product to add to your home. We are thrilled to welcome you to our growing community of Marvel owners, who trust in our products and our support.

The information in this guide is intended to help you install and maintain your new Marvel undercounter model to protect and prolong its lifetime. We encourage you to contact our Technical Support team at (616) 754-5601 with any questions.

Got a Marvelous Design?

We would love to see how your Marvel product looks in its new home. You can send us photos of your installed product at marketing@marvelrefrigeration.com, and we might feature your Marvel home design on our website and social media!

Bonus Third-Year Warranty Free with Product Registration

Your Marvel Professional product qualifies for a one-year extension of the two-year warranty coverage from your date of purchase, free of charge. To take advantage of this third-year warranty, be sure to register your product with Marvel within 60 days from the date of purchase at marvelrefrigeration.com and provide proof of purchase.



Thank you again for investing in Marvel for your home!

Warranty Registration

It is important you register your product warranty after taking delivery of your appliance. You can register online at www.marvelrefrigeration.com.

The following information will be required when registering your appliance:

- Serial Number
- Date of Purchase
- Dealer's name and address

Online registration available at marvelrefrigeration.com

The serial number can be found on the serial plate which is located inside the cabinet on the left side near the top.



TABLE OF CONTENTS

Tip: Click on any section below to jump directly there

Safety

Important Safety Instructions

Defrost

Remove Fan and Cover

Warranty

Installation

Unpacking Your Appliance

Electrical

Cutout & Product Dimensions

Side-by-Side & Stacking Installations

Door Reversal

Installing The Water Supply

Installing the Drain plumbing

Maintenance

Care and Cleaning

Stainless Steel Maintenance

Extended Non-Use

Operating Instructions

Using Your Electronic Control

Ice Maker Operation

Service

Obtaining Service

Troubleshooting

Wire Diagram

Product Liability

Warranty Claims

Ordering Replacement Parts

R600a Specifications

System Diagnosis Guide

Control Operation - Service

IMPORTANT SAFETY INSTRUCTIONS

Important Safety Instructions

Warnings and safety instructions appearing in this guide are not meant to cover all possible conditions and situations that may occur. Common sense, caution and care must be exercised when installing, maintaining or operating this appliance.

Recognize Safety Symbols, Words and Labels



WARNING

WARNING - You can be killed or seriously injured if you do not follow these instructions.



CAUTION

CAUTION - Hazards or unsafe practices which could result in personal injury or property/product damage.

NOTE

NOTE - Important information to help assure a problem-free installation and operation.



WARNING

State of California Proposition 65 Warning:
This product contains one or more chemicals known to the State of California to cause birth defects or other reproductive harm.



WARNING

State of California Proposition 65 Warning:
This product contains one or more chemicals known to the State of California to cause cancer.



WARNING

WARNING - This unit contains R600a (isobutane) which is a flammable hydrocarbon. It is safe for regular use. Do not use sharp objects to expedite defrosting. Do not damage refrigerant circuit.

UNPACKING YOUR APPLIANCE



WARNING

EXCESSIVE WEIGHT HAZARD

Use two or more people to move product.
Failure to do so can result in personal injury.

Remove Interior Packaging

Your appliance has been packed for shipment with all parts that could be damaged by movement securely fastened. Remove internal packing materials and any tape holding internal components in place. The getting started guide is shipped inside the product in a plastic bag along with the warranty registration card and other accessory items.

Important

Keep your carton and packaging until your appliance has been thoroughly inspected and found to be in good condition. If there is any damage, the packaging will be needed as proof of damage in transit. Afterwards, please dispose of all items responsibly.



WARNING

WARNING - Dispose of the plastic bags which can be a suffocation hazard.

Note to Customer

This merchandise was carefully packed and thoroughly inspected before leaving out facility. Responsibility for its safe delivery was assumed by the retailer upon acceptance of the shipment. Claims for loss or damage sustained in transit must be made to the retailer.

NOTE

DO NOT RETURN DAMAGED MERCHANDISE TO THE MANUFACTURER - FILE THE CLAIM WITH THE RETAILER.



CAUTION

If the appliance was shipped, handled or stored in other than an upright position for any period of time, allow the appliance to sit upright for a period of at least 24 hours before plugging in. This will assure oil returns to the compressor. Plugging the appliance in immediately may cause damage to internal parts.



WARNING

WARNING - Help Prevent Tragedies

Child entrapment and suffocation are not problems of the past. Junked or abandoned refrigerators are still dangerous, even if they sit outside for "just a few hours".

If you are getting rid of your old refrigerator, please follow the instructions below to help prevent accidents.

Before you throw away your old refrigerator or freezer:

- Take off the doors or remove the drawers.
- Leave the shelves in place so children may not easily climb inside.

ELECTRICAL

Electrical Connection

A grounded 115 volt, 15 amp dedicated circuit is required.

This product is factory equipped with a power supply cord that has a three-pronged, grounded plug. It must be plugged into a mating grounding type receptacle in accordance with the National Electrical Code and applicable local codes and ordinances. If the circuit does not have a grounding type receptacle, it is the responsibility and obligation of the customer to provide the proper power supply. The third-ground prong should not, under any circumstances, be cut or removed.

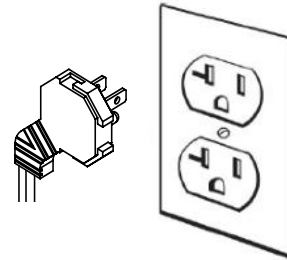
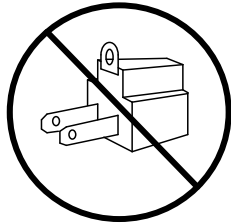
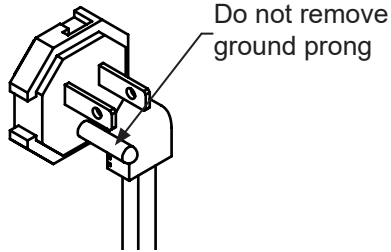

WARNING

Electrical Shock Hazard

- Do not use an extension cord with this appliance. They can be hazardous and can degrade product performance.
- This appliance should not, under any circumstances, be installed to an un-grounded electrical supply. Do not remove the grounding prong from the power cord.
- Do not use an adapter.
- Do not splash or spray water from a hose on the appliance. Doing so may cause an electrical shock, which may result in severe injury or death.

NOTE

Ground Fault Circuit Interrupters (GFCI) are prone to nuisance tripping which will cause the appliance to shut down. GFCI's are generally not used on circuits with power equipment that must run unattended for long periods of time, unless required to meet local building codes and ordinances.

CUTOUT AND PRODUCT DIMENSIONS

ROUGH-IN OPENING DIMENSIONS			CABINET DIMENSIONS					
"A"	"B"	"C"	"D"	"E"	"F"	"G"	"H"	"J"
15" (38.1 cm)	34" to 35" (86.4 cm to 88.9 cm)	24" (61 cm)	14 7/8" (37.8 cm)	33 3/4" to 34 3/4" (85.7 cm to 88.3 cm)	22 7/8" (58.1 cm)	26 3/8" (67 cm)	38 7/8" (98.7 cm)	17 1/2" (44.5 cm)

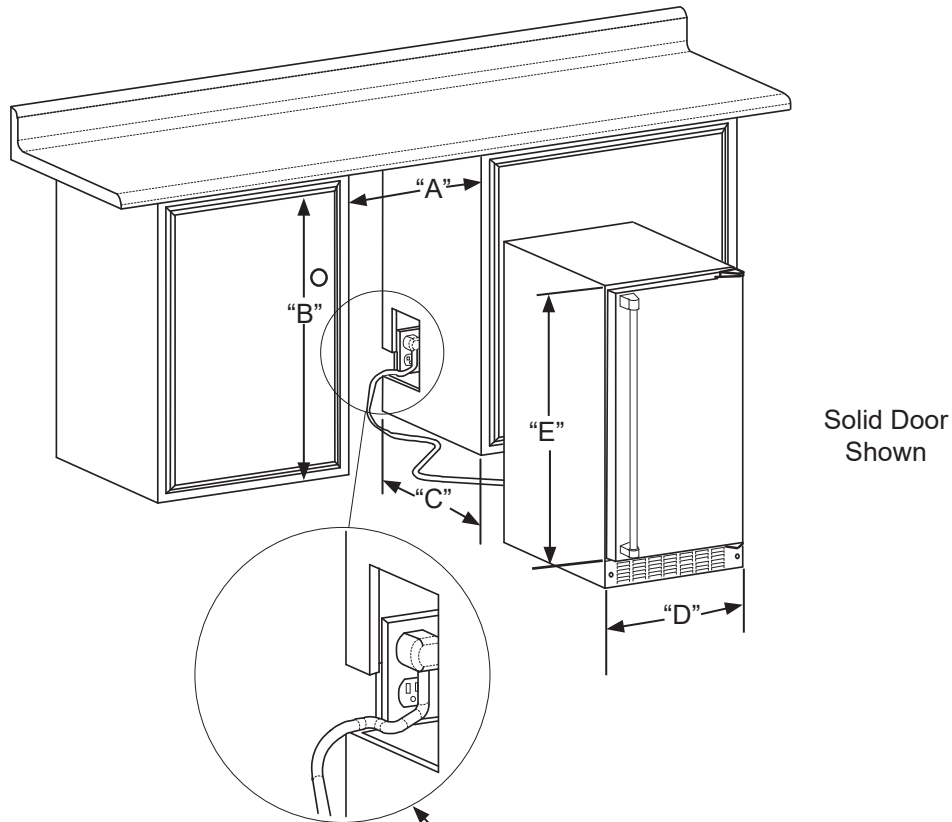

If necessary, to gain clearance inside the rough-in opening, a hole can be cut through the adjacent cabinet and the power cord routed through this hole to a power outlet. Another way to increase the available opening depth is to recess the power outlet into the rear wall to gain the thickness of the power cord plug. Not all recessed outlet boxes will work for this application as they are too narrow, but a recessed outlet box equivalent to Arlington #DVFR1W is recommended for this application.

CUTOUT AND PRODUCT DIMENSIONS

PRODUCT DATA	
ELECTRICAL REQUIREMENTS #	PRODUCT WEIGHT
115V/60Hz/15A	105 lbs (47.6 kg)

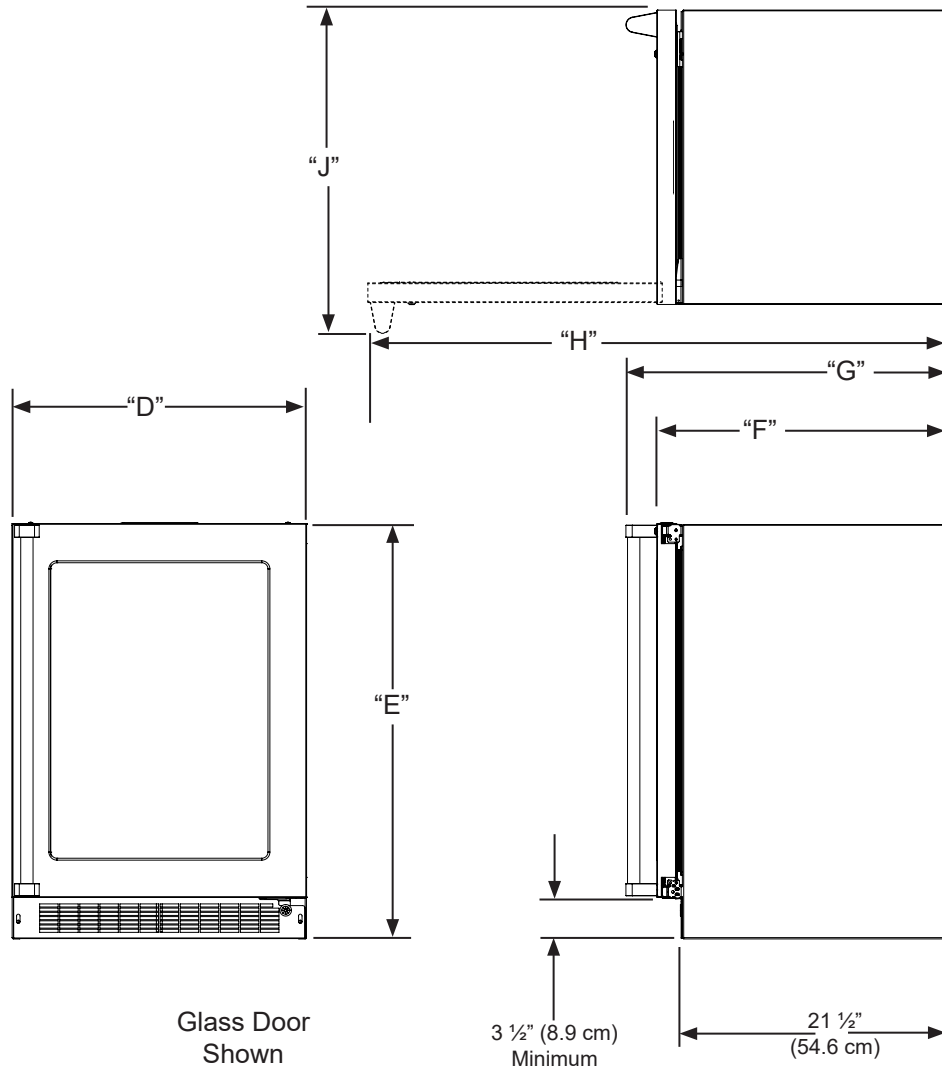

Minimum rough-in opening is required to be larger than the adjusted height of the cabinet.

A grounded 15-amp dedication circuit is required. Follow all local building codes when installing electrical and appliance.

SIDE-BY-SIDE AND STACKING INSTALLATIONS

Side-by-Side Installation

Other Site Requirements

Units must operate from separate, properly grounded electrical receptacles placed according to each unit's electrical specifications requirements.

To ensure unobstructed door swing (opening both doors at the same time), 1/4" (6.4 mm) of space needs to be maintained between the units.

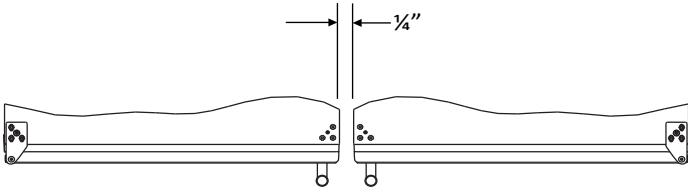

Figure 10

Hinge-by-Hinge Installation (Mullion)

When installing two units hinge-by-hinge, 13/16" (22 mm) is required for integrated models. Additional space may be needed for any knobs, pulls or handles installed.

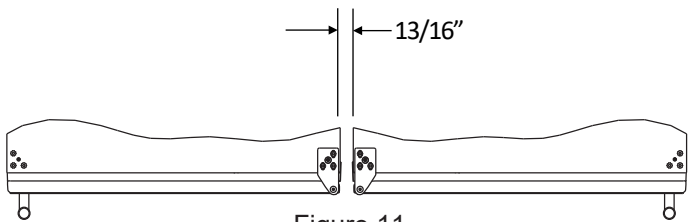

Figure 11

Stainless steel models which include the standard stainless handle will require 4-9/16" (116 mm) to allow both doors to open to 90° at the same time.

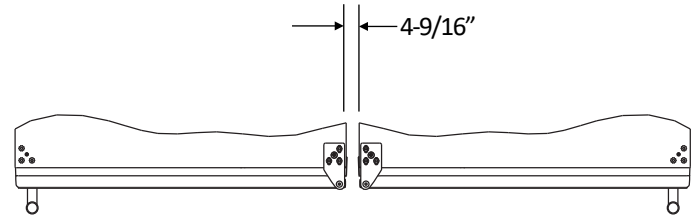

Figure 12

Hinge-by-Wall Installation

When installing a unit hinge-by-wall or adjacent cabinetry, 7/16" (11mm) is required for integrated models. Additional space may be needed for any knobs, pulls or handles installed.

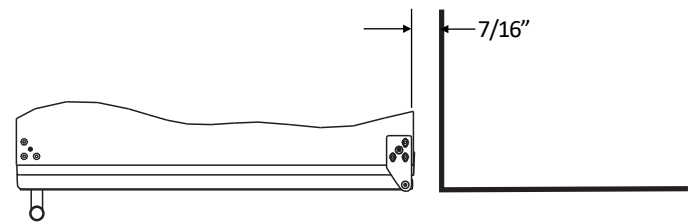

Figure 13

INSTALLING THE ANTI-TIP DEVICE

Anti-Tip Bracket

Use one of the methods below to secure the unit

Cabinet/Counter Anti-Tip Installation

(For built-in applications)

1. Slide unit out so screws on front of unit are easily accessible.
2. Remove the two screws from the front of the unit.

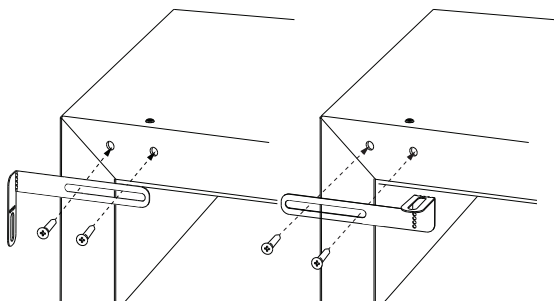

3. Bend bracket along one of the perforations to allow attachment to the desired adjoining surface.
4. Gently push unit into position. Be careful not to entangle the electrical cord or water line, if applicable.
5. Check to be sure the unit is level from front to back and side to side. Make any necessary adjustments. The unit's top surface should be approximately $\frac{1}{8}$ " (3 mm) below the countertop.
6. Secure bracket to adjoining surface.

Floor Mounted Anti-Tip Installation

(For free-standing applications)

1. Locate two anti-tip brackets included with the kit.
2. Place the unit into the area where it will be installed. Check the door, sides, and top for a proper fit. Also test to make sure the door opens and closes freely.
3. Remove grille and place a mark on the floor at the front of the unit. Also place a mark on the floor in the center of the unit.
4. Remove the unit. Using a square, extend center line "B" (see chart). This line serves as the back edge for the anti-tip brackets. From the center line, measure "A" to the left and right. This line is the outer edge of each bracket.

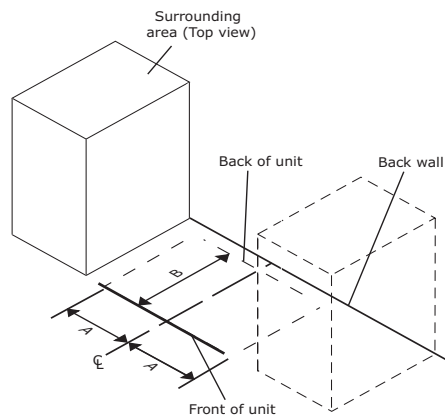

A	7 5/8"
B	22"

5. Place the anti-tip brackets on the floor against the line drawn for the outer edge. Mark spots for the screw holes.

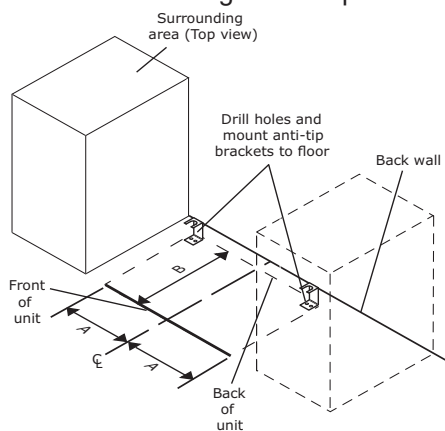

6. Use a $\frac{1}{8}$ " drill to make two starter holes and fasten the anti-tip brackets to the floor using the screws provided.
7. Place the unit back into position, making sure the feet engage the anti-tip brackets properly. Check the alignment of the lines made on the floor in step 3 with the position of the front feet to ensure proper positioning.

USING YOUR ELECTRONIC CONTROLS

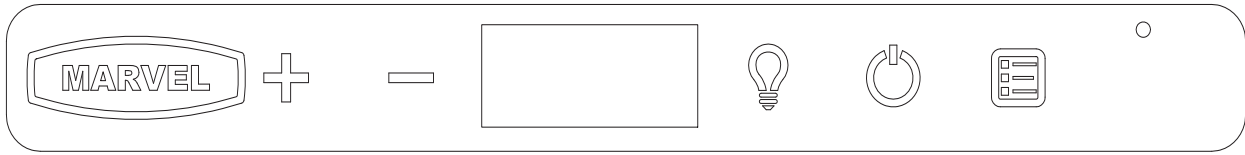

Control Function Guide

Function	Command	Notes												
ON/OFF	Press and release.	Unit will immediately turn ON or OFF.												
Adjust light color	Hold and press and release . Press to scroll through lighting options.	<table border="1"> <thead> <tr> <th>Option</th> <th>Open Door</th> <th>Closed Door</th> </tr> </thead> <tbody> <tr> <td></td> <td>White</td> <td>White</td> </tr> <tr> <td></td> <td>BrightShield™</td> <td>BrightShield™</td> </tr> <tr> <td></td> <td>(default) White</td> <td>BrightShield™</td> </tr> </tbody> </table>	Option	Open Door	Closed Door		White	White		BrightShield™	BrightShield™		(default) White	BrightShield™
Option	Open Door	Closed Door												
	White	White												
	BrightShield™	BrightShield™												
	(default) White	BrightShield™												
Toggle interior light - Door Closed	Press and release to toggle interior light option; press again to deactivate	Toggle depends on light color option above. Light output 50%												
Enable Sabbath Mode	Press and hold for 5 seconds and release	The °F / °C symbol will flash briefly after 5 seconds. Interior light and display will go dark and remain so until user resets mode - unit continues to operate												
Disable Sabbath Mode	Press and release	Display and interior light return to normal operation												
Clean Mode	Hold for 10 seconds to begin clean cycle.	Unit will return to normal operation upon completion cleaning. See "Care and Cleaning" section for more information.												
Showroom Mode	Hold and for 5 seconds	The °F / °C symbol will flash. Display will be lit and interior light will function. Unit will not cool. Repeat command to return to normal operation												

Door Alert Notification

When the door is left open for more than 30 minutes:

- A tone will sound for several seconds every minute
- will appear in display
- Close door to silence alert and reset

First Use

Initial startup requires no adjustments. When plugged in, the unit will begin operating under the factory default settings. If the unit was turned off during installation, simply press and the unit will immediately switch on. To turn the unit off, press .

USING YOUR ELECTRONIC CONTROLS

BrightShield™



This model includes BrightShield™ with Vyv™ Antimicrobial Light Technology.

BrightShield™

- Kills* and prevents the growth of viruses, bacteria, fungi, yeasts, mold, and mildew
- Provides continuous antimicrobial action to keep surfaces clean
- Is approved for continuous use around people, pets, & plants
- Reduces odors caused by bacteria, fungi, yeasts, mold, and mildew
- Creates a cleaner environment for food, beverages, & ice

* Testing on a non-enveloped virus (MS2 bacteriophage) showed a 97.12% reduction in controlled laboratory testing in 8 hours on hard surfaces. Testing on SARS-CoV-2 (enveloped virus) showed a 98.45% reduction in controlled laboratory testing in 4 hours on hard surfaces. Testing on MRSA E. coli showed 90%+ reduction in controlled laboratory testing in 24 hours on hard surfaces. Results may vary depending on the amount of light that is reaching the surfaces in the space

BrightShield™ is most effective when used continuously. Your unit is factory-set to use BrightShield™ lighting whenever the door is closed and standard bright white when the door is open. See Control Operations sections for details and other options.

For more information about BrightShield™ visit www.marvelrefrigeration.com

For more information about Vyv™ Antimicrobial Light Technology visit www.vyv.tech

INSTALLING THE WATER SUPPLY

Water Hookup



TO PREVENT DAMAGE TO YOUR ICE MACHINE AND/OR VOID YOUR WARRANTY, FOLLOW ALL WATER SUPPLY GUIDELINES AS LISTED BELOW.



Plumbing installation must observe all state and local codes. All water and drain connections **MUST BE** made by a licensed/qualified plumbing contractor. Failure to follow recommendations and instructions may result in damage and/or harm.

Water Supply

When connecting the water supply, please note the following:

- Water Mineral Content must meet the following:
 - TDS: less than 200 ppm (mg/l)
 - Hardness: Less than 200 mg/l (12 gpg)
- Water supply **MUST NOT** be from a water softener.
- A TDS meter is included with your unit
- Water Treatment Options
 - TDS level of 200 ppm or higher and/or a hardness of 12-19 gpg can be treated by Marvel's in-line water filter accessories available at marvelrefrigeration.com:
 - S41016343-ACCY — Standard
 - S41016344-ACCY — Large
 - S41016345-ACCY — Filter head 3/8" NPT, initial setup requires head & filter
 - Use bypass level 6

Measure Water TDS

Every Nugget Ice Machine comes with a TDS meter similar to the one below. The TDS meter measures the Total Dissolved Solids level that exists in the water supply; this is measured in ppm (parts per million).

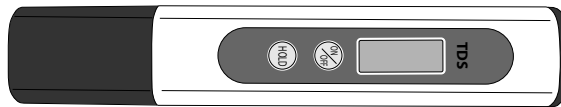

WARNING - The TDS meter does not test the toxicity of the water and is not to be used to determine potability. A TDS METER CANNOT DETECT THE TOXINS THAT MAKE WATER UNSAFE TO DRINK.

1. Turn on sink faucet and let run for 30 seconds.
2. Fill a clean glass (2 inches of water is sufficient).
3. Remove cap from meter.
4. Turn on meter and immerse meter into the water.

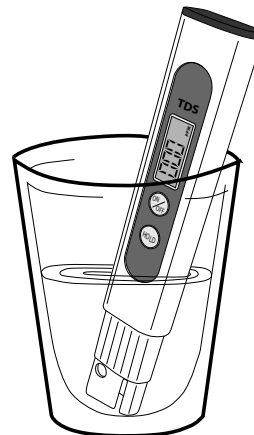

5. Leave meter immersed for 30 seconds.
6. Remove meter and check the readout for the TDS level in ppm - to save the reading, press the hold button.

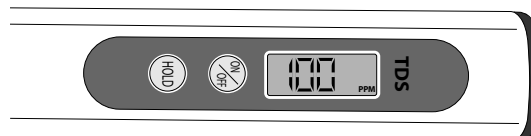

7. Turn off meter, dry off, and replace cap.

INSTALLING THE WATER SUPPLY

Based upon the TDS measurement, see the below table to determine the correct filter required to protect the ice machine.

Water Quality	1-3 Users	4+ Users
200 TDS and/or 12 gpg hardness or less	Required Standard Filter Change 1x per year	Required Large Filter Change 1x per year
201-400 TDS and/or 12-19 gpg hardness	Required Large Filter Change 1x per year	Required Large Filter Change 2x per year
400+ TDS, and/or 20+ gpg hardness	Contact your local water professional	

- The water pressure should be between 20 and 120 psi (138 and 827 kPa).
- The water line MUST have a shut-off valve in the supply line.
- The water line should be looped into 2 coils. This will allow the unit to be removed for cleaning and servicing. Make certain that the tubing is not pinched or damaged during installation.

CAUTION

Do not use any plastic water supply line. The line is under pressure at all times. Plastic may crack or rupture with age and cause damage to your home.

Do not use tape or joint compound when attaching a braided flexible water supply line that includes a rubber gasket. The gasket provides an adequate seal – other materials could cause blockage of the valve.

Failure to follow recommendations and instructions may result in damage and/or harm, flooding or void the product warranty.

Use new hose set. Do not reuse old hose set.

CAUTION

Turn off water supply and disconnect electrical supply to unit prior to installation.

Use caution when handling back panel. The edges could be sharp.

Water Hookup

1. Turn off water supply and disconnect electrical supply to product prior to attempting installation.
2. Remove the back panel.
3. Thread water line through back panel hole (with bushing).
4. Locate water valve inlet and connect to valve.

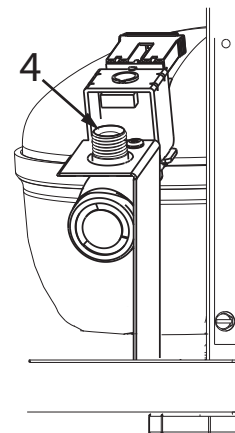
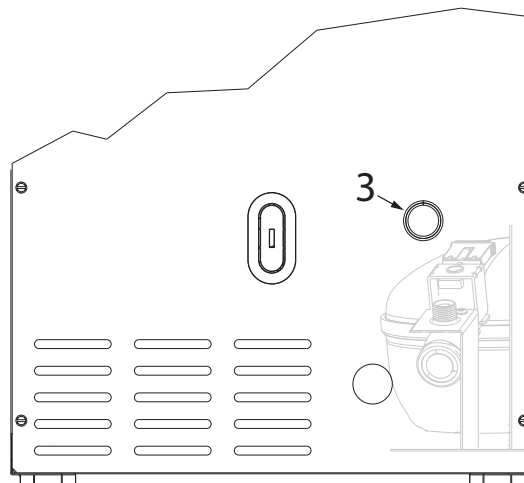

5. Turn on water supply and check for leaks.
6. Reinstall back panel.

INSTALLING THE DRAIN PLUMBING

Drain

Model numbers including “CL” or “NB” do not include a factory installed drain pump.

Model numbers including “CP” or “NP” include a factory installed drain pump.

Drain Connection

! CAUTION

If your Marvel unit did not come with a factory installed drain pump you must use a gravity style drain connection. For assistance in determining if your unit has a pump please contact Marvel. The floor drain must be large enough to accommodate drainage from all attached drains. Follow these guidelines when installing drain lines to prevent water from flowing back into the ice maker storage bin and/or potentially flowing onto the floor, which may result in personal injury or property damage

NOTE

Drain can NOT be located directly below the unit. Unit has a solid base that will not allow the unit to drain below itself. There is a possibility that hose connections may have loosened during shipment. Verify all connections and fittings are free from leaks.

! CAUTION

This equipment is to be installed with adequate backflow protection to comply with applicable federal, state and local codes.

Gravity Drain

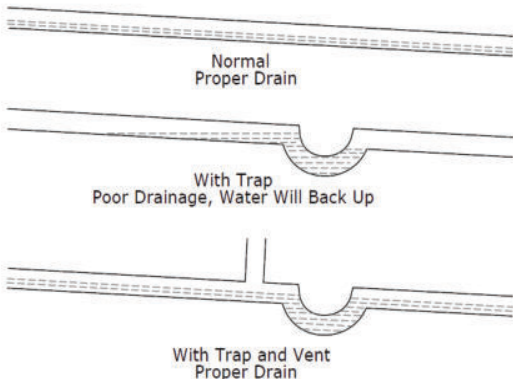

A gravity drain may be used if:

- Drain line has at least a 1” drop per 48” (approximately 2 cm drop per 100 cm) of run.
 - Drain line does not create traps and is vented per local code.
1. Cut the pre-installed drain tube to length.
 2. Connect to your local plumbing per the local code.
 3. If necessary, insulate drain line to prevent condensation.

! CAUTION

Failure to connect water supply or drain line connections properly can result in personal injury and property damage. Gravity drain connections must be routed downward from the rest of the unit at the rate of 1/4” per foot (1 cm per 50 cm).

Factory Installed Drain Pump

If your drain line will run up to a stand pipe, disposal or spigot assembly, or does not otherwise meet the requirements for a gravity drain, you may have ordered a pre-installed drain pump. If you need to install a drain pump into your unit, see Drain Pump section in the Owner’s Guide.

See next page for typical installations requiring a drain pump.

INSTALLING THE DRAIN PLUMBING

Stand Pipe
P60 Pump Required

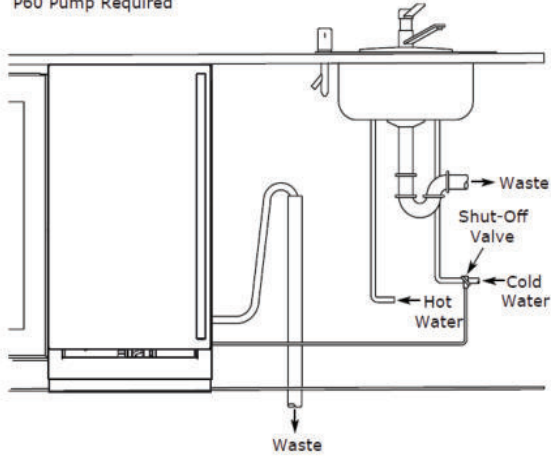

NOTE

The maximum lift for the P60 drain pump is 10 feet. This must be done as close to the rear of the unit as possible.

Disposal Assembly
P60 Pump Required

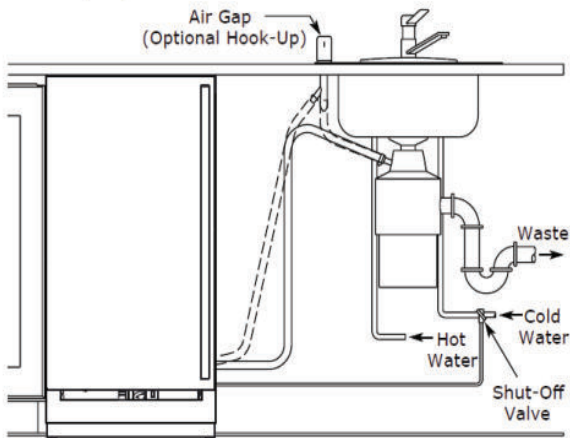

Y-Branch Tailpiece
P60 Pump Required

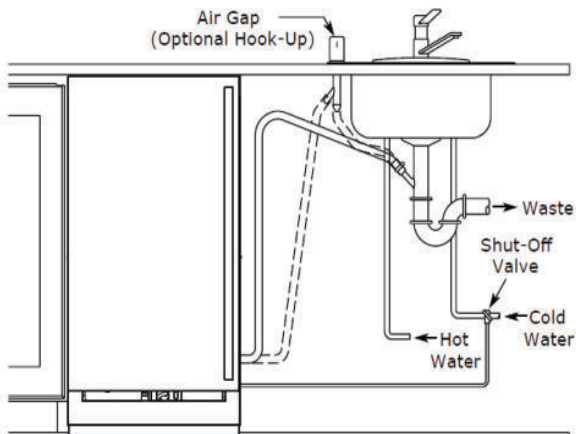

ICE MAKER OPERATION





ice

The Nugget Ice Machine produces cylindrical bits of compressed ice approximately 3/4" x 1/2".

Ice is produced until the machine senses the bin is full. As ice slowly melts in the bin, the level of ice drops and ice production resumes. This ensures a constant supply of fresh ice is always available.

The factory default ice setting is 0, which produces a firm and compact ice nugget. Marvel's ice adjustability allows you to choose five levels of density from 0 to -5. At -5 the ice is soft.

To adjust the ice density:

1. Hold  for 5 seconds - display will flash current ice setting.
2. Adjust using  or .
3. Confirm by pressing .

CARE AND CLEANING

Exterior Cleaning - Stainless Models

Stainless door panels, handles and frames can discolor when exposed to chlorine gas, pool chemicals, saltwater or cleaners with bleach.

Keep your stainless unit looking new by cleaning with a good quality all-in-one stainless steel cleaner and polish monthly. For best results use Claire® Stainless Steel Polish and Cleaner. Comparable products are acceptable. Frequent cleaning will remove surface contamination that could lead to rust. Some installations may require cleaning weekly.

CAUTION

Do not clean with steel wool pads. Do not use cleaners not specifically intended for stainless steel on stainless steel surfaces (this includes glass, tile, and counter cleaners). Do not use stainless steel cleaners or polishes on any glass surfaces. Clean any glass surfaces with a non-chlorine glass cleaner.

If any surface discoloring or rusting appears, clean it quickly with Bon-Ami® or Barkeepers Friend Cleanser® and a nonabrasive cloth. Always clean with the grain. Always finish with Claire® Stainless Steel Polish and Cleaner or comparable product to prevent further problems.

CAUTION

Using abrasive pads such as ScotchBrite™ will cause the graining in the stainless steel to become blurred. Rust not cleaned up promptly can penetrate the surface of the stainless steel and complete removal of the rust may not be possible.

Panel-Ready Models

To clean integrated panels, use household cleaner per the cabinet manufacturer's recommendations.

Interior Cleaning

Disconnect power to the unit. Clean the interior and all removed components using a mild nonabrasive detergent and warm solution applied with a soft sponge or non-abrasive cloth. Rinse the interior using a soft sponge and clean water.

CAUTION

Do not use any solvent-based or abrasive cleaners. These types of cleaners may transfer taste and/or odor to the interior products and damage or discolor the interior.

Ice Machine Cleaning Cycle

This ice machine has an automatic clean alert function. The control will indicate CL in the display, reminding you to clean your unit. When CL is displayed, ice production will continue. Depending on water conditions, more frequent cleaning may be necessary: see chart below. Cleaning removes lime scale, other mineral deposits, and sanitizes the machine. Poor ice quality and reduced ice output are signs that cleaning is necessary.

CAUTION

BEFORE RUNNING THE CLEANING CYCLE, MEASURE THE TDS (TOTAL DISSOLVED SOLIDS) LEVEL OF YOUR WATER SUPPLY.

(See Installing the Water Supply section in this guide to find instructions for using the TDS meter that was included with this ice machine.)

TDS (Total Dissolved Solids) (ppm)	Cleaning Interval
5 - 150 ppm	6 months
150 - 200 ppm	4 months

Replacement TDS meter may be ordered at marvelrefrigeration.com, part # 80-55672-00.

CARE AND CLEANING

Under normal conditions cleaning should be done when the display shows . You may initiate a cleaning cycle at any time by pressing and holding the clean button for 10 seconds. will appear in the display indicating the start of the cleaning process.

Failure to clean may reduce the quality and quantity of ice produced. Once the clean cycle begins, it can be canceled by pressing three times. Press once more to start making ice. The clean cycle will automatically cancel if user fails to activate control at steps 2, 3b, and 5b within 2 hours.

Required for cleaning:

- Hose and funnel - provided with unit
- Bucket and cleaning sponge
- Clean potable water
- SafeCLEAN Plus™ Cleaner
1-8oz. bottle - Available for purchase from Marvel

Need more cleaner? Call Marvel Customer Service at 616.754.5601.



CAUTION

Use only SafeCLEAN Plus™ Cleaner. Use of any other cleaner may damage the finish of the evaporator and will void the warranty. Follow safety and handling instructions printed on the SafeCLEAN Plus™ bottle.

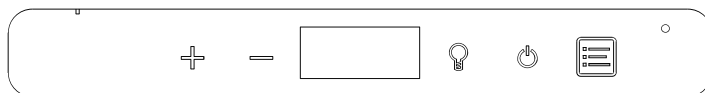

Figure 38

1. Press and Hold for 10 seconds
 - a. will appear in the display
 - b. Remove access shield
 - c. Remove all ice in bin
 - d. Remove any ice protruding from the ice dispenser tube.
2. Insert the end of the cleaning tube into the ice dispenser; slowly pour in approximately 1 quart of hot (min. 100° F) potable water. This will melt ice inside the dispenser tube. It is normal for some water to flow from the ice dispenser tube and exit from the vent tube while pouring. Omit this step if no ice is in the ice dispenser tube.

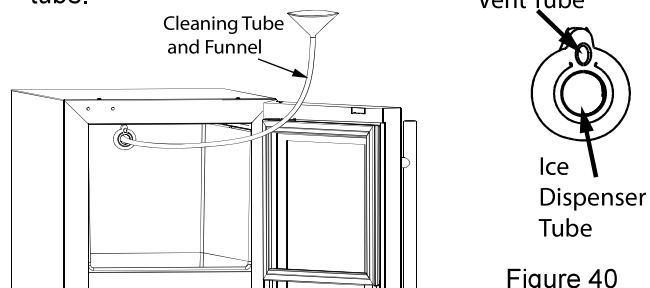

Figure 39

Figure 40

3. Press and release
 - a. will appear in the display
 - b. Mix 4 ounces of SafeCLEAN Plus™ with 2 quarts of potable water.
4. Wait until appears in the display
 - a. Using the funnel and cleaning tube, slowly pour 3/4 of the cleaning solution into the dispenser tube. Air and some water will exit the vent tube. Remove cleaning tube.
 - b. Press and release
5. will appear in the display
 - a. The machine will circulate the solution, cleaning and sanitizing the internal components, for approximately 20 minutes.
 - b. While the machine is circulating the cleaning solution, use 1/2 of the remaining cleaning solution and a sponge to wipe down the inside of the ice bin and scoop. Rinse with clean potable water.
6. When appears in the display, 3 soft tones will sound, indicating the cleaning phase is complete.
 - Using the hose and funnel, slowly pour 1.5 quarts (48 oz.) of clean potable water into the ice dispenser tube. Air and some water will exit the vent tube.

CARE AND CLEANING

7. **06** will appear in the display
 - a. Reinstall shield and close door.
 - b. The machine will circulate water and perform a series of final rinses for approximately 15 minutes.
 - c. The unit will resume making ice - indicated by 3 soft tones and **ICE** scrolling in the display.
 - d. Discard first 10 minutes of ice production.

Cleaning Condenser

INTERVAL - EVERY SIX MONTHS

To maintain operational efficiency, keep the front grille free of dust and lint, and clean the condenser when necessary. Depending on environmental conditions, more or less frequent cleaning may be necessary.



WARNING

WARNING - Connect to potable water supply only.

NOTE

DO NOT use any type of cleaner on the condenser unit. Condenser may be cleaned using a vacuum, soft brush, or compressed air.

1. Remove the grille (See GRILLE INSTALLATION).
2. Clean the condenser coil using a soft brush or vacuum cleaner.
3. Install the grille.

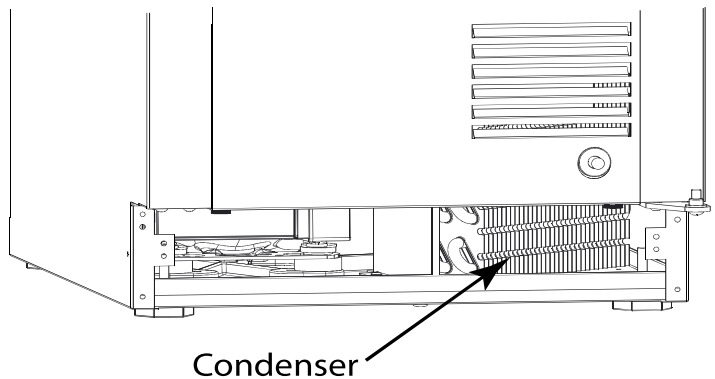

Figure 41

CARE AND CLEANING

Extended Non-Use

VACATION/HOLIDAY, PROLONGED SHUTDOWN

The following steps are recommended for periods of extended non-use:

1. Remove all consumable content from the unit.
2. Disconnect the power cord from its outlet/socket and leave it disconnected until the unit is returned to service.
3. Turn off the water supply.
4. If ice is on the evaporator, allow ice to thaw naturally.
5. Clean and dry the interior of the unit. Ensure all water has been removed from the unit.
6. Disconnect the water and drain line (if applicable) making sure all water is removed from the lines.
7. The door must remain open to prevent formation of mold and mildew. Open door a minimum of 2" (50 mm) to provide the necessary ventilation.

WINTERIZATION

If the unit will be exposed to temperatures of 40°F (5°C) or less, the steps above must be followed. In addition, P60 drain pumps must be drained according to the following procedure:

1. Remove the drain pump from the ice machine.
2. Drain the water in the pump's reservoir by turning the pump upside down and allowing the water to drain through the pump's inlet and vent tube fittings.
3. After water is drained, reinstall the drain pump and reattach all connections.

For questions regarding winterization, please call Marvel Refrigeration at 616.754.5601



Damage caused by freezing temperatures is not covered by the warranty. Do not put anti-freeze in your unit.

STAINLESS STEEL MAINTENANCE

Background

Stainless steel does not stain, corrode, or rust as easily as ordinary steel, but it is not stain or corrosion proof. Stainless steels can discolor or corrode if not maintained properly.

Stainless steels differ from ordinary carbon steels by the amount of chromium present. It is this chromium that provides an invisible protective film on the surface called chrome-oxide. This protective chrome-oxide film on the surface can be damaged or contaminated, which may result in discoloration, staining, or corrosion of the base metal.

Care & Cleaning

Routine cleaning of the stainless steel surfaces will serve to greatly extend the life of your product by removing contaminants. This is especially important in coastal areas which can expose the stainless to severe contaminants such as halide salts, (sodium chloride).

It is strongly recommended to periodically inspect and thoroughly clean crevices, weld points, under gaskets, rivets, bolt heads, and any locations where small amounts of liquid could collect, become stagnant, and concentrate contaminants. Additionally, any mounting hardware that is showing signs of corrosion should be replaced.

Frequency of cleaning will depend upon the installation location, environmental, and usage conditions.

Choosing a Cleaning Product

The choice of a proper cleaning product is ultimately that of the consumer, and there are many products from which to choose. Depending upon the type of cleaning and the degree of contamination, some products are better than others.

Typically the most effective and efficient means for routine cleaning of most stainless steel products is to give the surfaces a brisk rubbing with a soft cloth soaked in warm water and a gentle detergent, or mild mixture of ammonia. Rubbing should, to the extent possible, follow the polish lines of the steel, and always insure thorough rinsing after cleaning.

Although some products are called "stainless steel cleaners," some may contain abrasives which could scratch the surface, (compromising the protective chrome-oxide film), and some many contain chlorine bleach which will dull, tarnish or discolor the surface if not completely removed.

After the stainless surfaces have been thoroughly cleaned, a good quality car wax may be applied to help maintain the finish.

NOTE

Stainless steel products should never be installed, or stored in close proximity to chlorine chemicals.

Whichever cleaning product you chose, it should be used in strict accordance with the instructions of the cleaner manufacturer.

EXTENDED NON-USE

Extended Non-Use

Vacation/Holiday - Prolonged Shutdown

The following steps are recommended for periods of extended non-use:

1. Remove all consumable content from the unit.
2. Disconnect the power cord from its outlet/socket and leave it disconnected until the unit is returned to service.
3. Turn off the water supply.
4. If ice is on the evaporator, allow ice to thaw naturally.
5. Clean and dry the interior of the cabinet. Ensure all water has been removed from the unit.
6. Disconnect the water and drain line (if applicable) making sure all water is removed from the lines.
7. The door must remain open to prevent formation of mold and mildew. Open door a minimum of 2" (50 mm) to provide the necessary ventilation.

Winterization

If the unit will be exposed to temperatures of 40°F (5°C) or less, the steps above must be followed. In addition, P60 drain pumps in clear ice machines must be drained according to the following procedure:

1. Remove the drain pump from the ice machine.
2. Drain the water in the pump's reservoir by turning the pump upside down and allowing the water to drain through the pump's inlet and vent tube fittings.
3. After water is drained, reinstall the drain pump and reattach all connections.

For questions regarding winterization, please call Marvel at 616.754.5601.



Damage caused by freezing temperatures is not covered by the warranty. Do not put anti-freeze in your unit.

OBTAINING SERVICE

If Service is Required:

- If the product is within the first year warranty period please contact your dealer or call Marvel Customer Service at 616.754.5601 for directions on how to obtain warranty coverage in your area.
- If the product is outside the first year warranty period, Marvel Customer Service can provide recommendations of service centers in your area. A listing of authorized service centers is also available at www.marvelrefrigeration.com under the service and support section.
- In all correspondence regarding service, be sure to give the service number, serial number, and proof of purchase.
- Try to have information or description of nature of the problem, how long the appliance has been running, the room temperature, and any additional information that may be helpful in quickly solving the problem.
- Table "B" is provided for recording pertinent information regarding your product for future reference.

For Your Records	
Date of Purchase	
Dealer's name	
Dealer's Address	
Dealer's City	
Dealer's State	
Dealer's Zip Code	
Appliance Serial Number	
Appliance Service Number	
Date Warranty Card Sent (Must be within 10 days of purchase).	

Table B

Troubleshooting

BEFORE CALLING FOR SERVICE

If you think your Marvel product is malfunctioning, read the CONTROL OPERATION section to clearly understand the function of the control.

If the problem persists, read the NORMAL OPERATING SOUNDS and TROUBLESHOOTING GUIDE sections below to help you quickly identify common problems and possible causes and remedies. Most often, this will resolve the problem without the need to call for service.

If your product needs service, please go to www.marvelrefrigeration.com and navigate to the Service page to locate a Marvel Authorized servicer. If your product is in warranty please make sure to register it at www.marvelrefrigeration.com/warranty-registration. If you have any issues following this process you can contact Marvel Refrigeration by phone at +1.616.754.5601.

If you call, you will need your product Model and Serial Numbers. This information appears on the Model and Serial number plate located on the interior of your product, most often placed on the ceiling.

NORMAL OPERATING SOUNDS

All models incorporate rigid foam insulated cabinets to provide high thermal efficiency and maximum sound reduction for its internal working components. Despite this technology, your model may make sounds that are unfamiliar.

Normal operating sounds may be more noticeable because of the unit's environment. Hard surfaces such as cabinets, wood, vinyl or tiled floors and paneled walls have a tendency to reflect normal appliance operating noises.

Listed below are common refrigeration components with a brief description of the normal operating sounds they make. NOTE: Your product may not contain all the components listed.

- Compressor: The compressor makes a hum or pulsing sound that may be heard when it operates.

- Evaporator: Refrigerant flowing through an evaporator may sound like boiling liquid.
- Condenser Fan: Air moving through a condenser may be heard.
- Running Water: As your unit continues to produce ice you will hear water flowing into the collection chambers and running through the evaporator.

TROUBLESHOOTING GUIDE



ELECTROCUTION HAZARD. Never attempt to repair or perform maintenance on the unit before disconnecting the main electrical power.

Troubleshooting - What to check when problems occur:

Problem	Possible Cause and Remedy
Unit Does Not Operate. Electronic Display Blank.	No electrical supply. Plug unit in or check circuit breaker.
Display Showing Error Code.	If display shows error "dr", check to make sure door is sealing correctly. Make sure to close door completely. If sealing the door does not clear the error, contact U-Line service for more information.
Unit Develops Condensation on External Surfaces.	The unit is exposed to excessive humidity. Moisture will dissipate as humidity levels decrease.
Poor Ice Quality.	Unit may not be level. Check if unit is level. Ice maker system may be dirty. Clean the ice maker.
No Ice Production.	Ensure water is being supplied to the unit. Verify the ice making unit is turned on.
Not Enough Ice.	Ensure the condenser coil is clean and free of any dirt or lint build-up.
Water in Ice Bin.	Drain may be restricted, ensure drain is free of foreign debris.

APPENDIX

E11: Sensor in base near fan detecting water

This sensor is designed to detect water escaping the product due to any type of malfunction inside the machine. Once activated, the only way to reset this error is to completely dry the two probes and cycle power to the machine via the rocker switch or power cord. Once power is cycled, it will take 20 minutes to reactivate the error code. Only the drain pump will retain power and be able to activate under this condition.

Inspect the entire base area in front and behind the sensors.

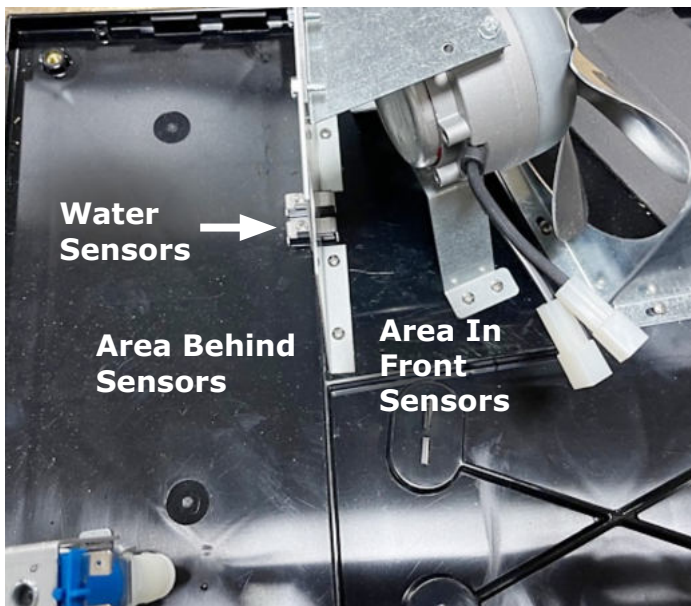

1. If the unit is equipped with a drainage pump, inspect it for leaks - check connections.
2. Remove pump and check all connections on water valves, water supply, and drain.
3. Check bolt on water reservoir. If loose, it may leak during a clean cycle when reservoir is filled to the top. Torque Spec. is 16 in-lbs.
4. Check areas around ice maker auger on both ends. If any leakage is evident, it is likely poor water quality and/or failure to clean is the cause.
 - a. Check TDS - if outside tolerance, please report to factory and advise homeowner that repairs cannot be made to unit until water quality issue is resolved. Filters available at u-line.com are able to treat TDS up to 600.

- b. If TDS is acceptable, unit must be cleaned and any leakage addressed with a seal kit. (Marvel service part # 80-55371-13)

Area in Front of Sensors (Condenser Side) is Wet

- Check connection from bin to drain.

No Water is Evident

1. Power cycle to reset error
2. Check sensors to ensure there is a gap between sensors and pan as shown.
3. If error persists, check wiring to sensors for a short.

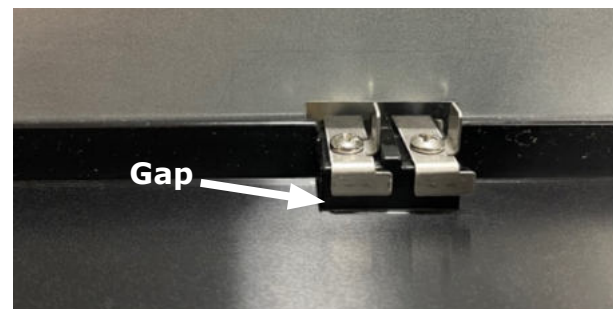

E12: Float switch in reservoir not rising

This error is designed to ensure sufficient water exists to produce ice, thus preventing permanent damage to the module. In order for this error to occur, the ice-making sequence must initiate two tries to fill the reservoir. This may take an hour or more to generate the error code.

Steps to check and correct - remember it is necessary to power cycle after making the corrections.

1. Check incoming water supply to ensure it is turned on and has sufficient pressure.
2. Verify water filter(if applicable) is in place and has been replaced on schedule.
3. If unit is a 1 Class product, enter service mode and activate relay 4 to determine if unit fills with water.
 - a. If it does not fill, check water valve for power during sequence.
 - If there is power, check valve resistance to determine if coil is shorted.
 - Check valve to ensure it is not blocked with debris.

- b. If unit fills, the float switch is malfunctioning and needs to be replaced (part # 80-55538-00).
- 4. If unit is 3 Class product, enter service mode and activate relays 1 and 4 to determine if unit fills with water.
 - a. If it does not fill, check water valve for power during sequence.
 - If there is power, check valve resistance to determine if coil is shorted.
 - Check valve to ensure it is not blocked with debris.
 - b. If unit fills, the float switch is malfunctioning and needs to be replaced (part # 80-55538-00).

E13: Float switch in reservoir not dropping quickly enough

This error is designed to detect insufficient ice product due to overheating or poor water quality. Failure to address this error can cause permanent damage not covered under warranty. The user may notice deteriorating ice quality prior to the error.

Steps to check and correct - remember it is necessary to power cycle after making the corrections.

- 1. Ice is slushy and user noticed deterioration in quality prior to the error.
 - a. Check condenser and toe kick. Fan must be operating and clear of debris.
 - b. Check TDS level. High levels of TDS will result in this error.
- 2. In more severe conditions, not covered above, the unit may run up to an hour prior to generating this error, resulting in very slushy ice or no ice production at all.
 - a. High TDS. High TDS restricts ability to produce ice and causes excessive buildup of minerals on the ice-making mechanism. A single cleaning may not resolve this condition.
 - b. General cleaning has not been performed. A single cleaning may not resolve this condition.
 - c. If customer has unit connected to a water softener, have them consult a plumber to disconnect from the softener.

- d. Check compressor operation.
 - If unit is not cooling or compressor is not operating, diagnose and fix system problem.
 - If unit is cooling, check auger for rotation. If not rotating, check the motor and electrical connections to auger.
- 3. If the ice has been solid and appears solid after a power cycle check it is possible the float switch is not operating properly and should be replaced.

P1: Drain related error

This error is designed to prevent water related issues due to a failure of the unit to drain water. In most cases this error is not related to the unit and related to improper installation or restriction of the drain line.

- 1. If the unit does not have a drain pump this error is generated by a missing jumper on the power harness. Inspect and install jumper.
- 2. If the unit does have a drain pump.
 - a. Check the installation to ensure the drain line is not restricted leaving the unit.
 - b. Inspect the drain pump to determine if the motor is operating. A slight noise should be heard if the pump is full of water.

Ice Level Issues

If there is a complaint regarding the unit filling too full with ice.

- 1. Check the thermistor to ensure it is installed properly and any holes through the rear of cabinet are completely sealed with sealing compound. Warm air that can make its way to the thermistor will give improper readings and cause the bin to overflow.
- 2. The bin thermistor offset may be changed via service mode option #5. Be careful to adjust in small increments to suit customer preferences.

42374_A

42375_A

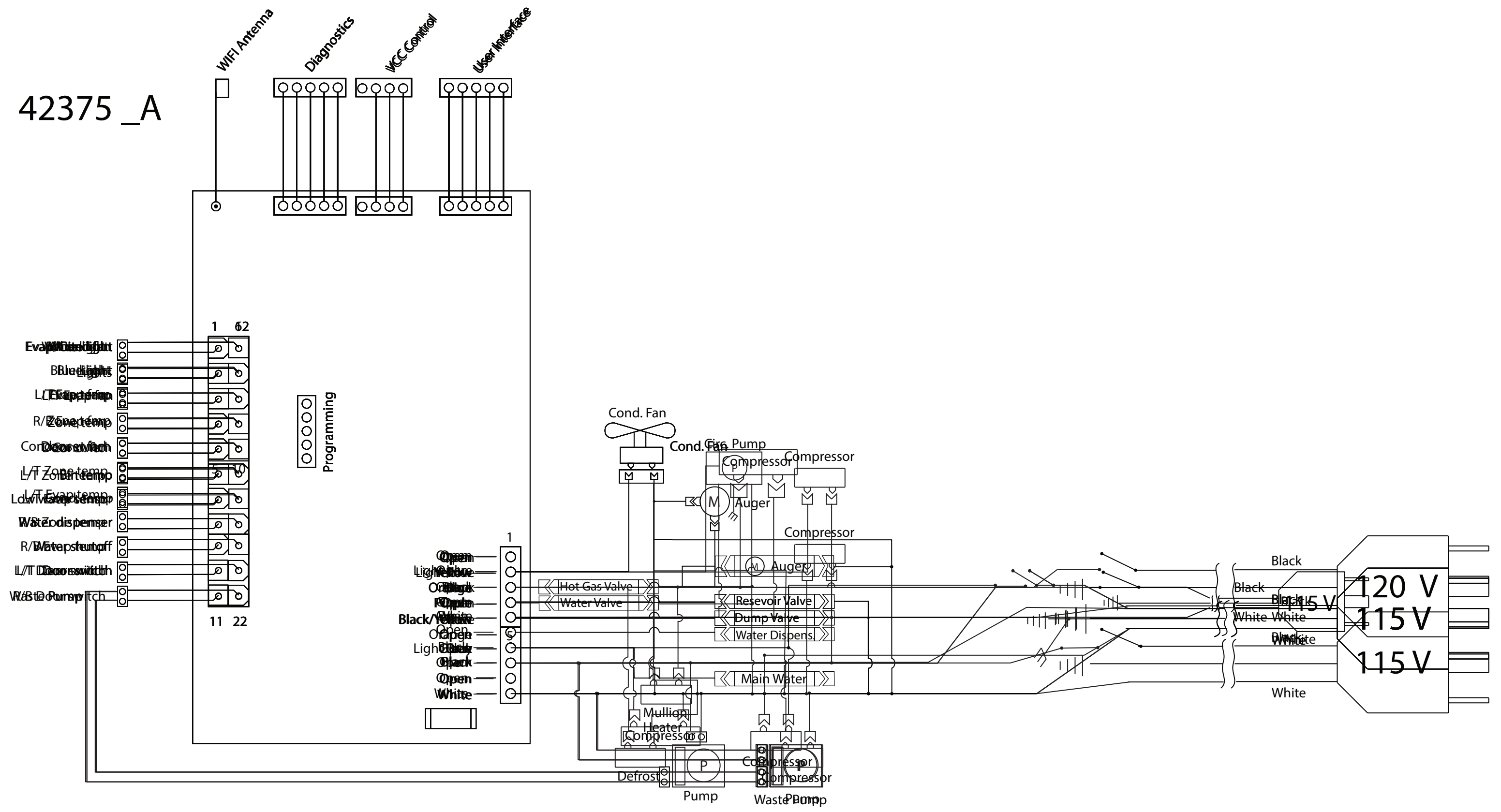

Product Liability

Field service technicians are authorized to make an initial assessment in the event of reported damages. If there are any questions about the process involved, the technician should call Marvel for further explanation.

While inspecting for defects or installation issues, photos should be taken to document any damages or issues found.

During the assessment, if the service technician is able to find the source of the damage and it can be resolved by replacement of a part, the servicer is authorized to replace the part in question. The part that caused the damage must be returned to Marvel in its entirety. The part must be clearly labeled with the serial number of the unit it was removed from, the date, and the servicer who removed the part.

If the service technician determines the damage is the result of installation issues (water connection/drain, etc.), the consumer would be notified and the issues shall be resolved at the direction of the consumer.

If damage is evident and the service technician is unable to find the source, Marvel must be contacted at 616.754.5601 for further direction.

1260 E. Van Deinse St • Greenville, MI 48838

T: +1.616.754.5601

Website: www.marvelrefrigeration.com

The original refrigeration experts since 1892.



Warranty Claims

The following information defines the parameters for filing a warranty claim:

- Valid serial number needed
- Valid model number needed
- Claims must be submitted online at www.marvelservice.com
- 60 day submittal deadline from date of completed service
- Only one repair or unit per warranty claim
- Part order numbers will be required when submitting for warranty labor

Units must be registered prior to warranty submittal. Customers may register at www.marvelrefrigeration.com. A proof of purchase is required. We also accept the following information to update warranty:

- New construction occupancy documents
- Closing paperwork
- Final billing - Remodel

Warranty parts will be shipped at no charge after Marvel confirms warranty status. Please provide the model, serial number, part number and part description. Some parts will require color or voltage information.

17 14862 05 0527

Year Month Day Factory
 use Only

Ordering Replacement Parts

Parts may be ordered online at partsformarvel.com

Or contact:

www.marvelrefrigeration.com (Servicers choose "Login" for service account).

Phone Number: (616) 754-5601

NOTICE

Use only genuine Marvel replacement parts. The use of non-Marvel parts can reduce performance, damage the unit, and void the warranty.

Warranty parts will be shipped at no charge after Marvel confirms warranty status. Please provide the model, serial number, part number and part description. Some parts will require color or voltage information.

Marvel requires the return of original parts, we will inform you when the parts order is taken. This requirement will be noted on your packing list. A prepaid shipping label will be emailed to you. Please enclose a copy of the parts packing list and be sure the model and serial numbers are legible on the paperwork. Tag the part with the reported defect.

Customers and non-authorized servicers may order non-warranty parts at www.partsformarvel.com. Authorized servicers with a servicer login may order non-warranty parts at www.marvelrefrigeration.com.

R-600A Specifications & Handling

WARNING

Flammability warnings for a pure-iso-butane refrigerant.



Gloves and Eye Protection must be used.



R-600a is considered non-toxic, but is flammable when mixed with air.

Keep a dry powder type fire extinguisher in the work area.



R-600a is heavier than air, do not allow any leakage/migration to low areas such as basements and stairs.

Never use a torch on a fully charged refrigeration system.

Never substitute Marvel OEM replacement parts or methods of construction.

R-600a must be stored and transported in approved containers.

⚠ WARNING

Only skilled and well trained service technicians permitted to service R-600a equipped products.

All tools and equipment must be approved for use with R-600a refrigerant.

Local, state and federal laws, standards must be observed along with proper certification and licensing.

Ventilation is required during servicing.

No conversions to R-600a from any other refrigerants. OEM R-600a equipped unit only.

Service area must be free of ignition sources.

No smoking is allowed in the service area.

All replacement electrical components must be OEM and installed properly (sealed and covered).

If the evaporator is cold prior to service, it must be thawed prior to service.

When using a vacuum pump, start pump before opening refrigeration system.

Vacuum pump and recovery equipment should be at least 10 feet from the work area.

It is recommended that a simple LPG gas detector is on site during service.

Ensure that all R-600a is removed from the system prior to brazing any part of the sealed system.

Only a clean, dry leak free system should be charged with R-600a.

R-600A SPECIFICATIONS/LABELING

R-600a equipped products are labeled (both the unit and the compressor).

R-600a is colorless and odorless.

R-600a is considered non-toxic, but is flammable when mixed with air.

Do not remove or alter any R-600a labeling on the product.

Use only a refrigerant grade R-600a from a properly labeled container.

RECOVERING/RECLAIMING R-600A

(R-600a has been exempted from recovery/reclaiming requirements by the US EPA)

Recovery/Reclaiming equipment must be approved for use with R-600a.

Ensure the evaporator is at room temperature prior to recovery/reclaiming R-600a.

Use a common piercing pliers or piercing valve to remove R-600a from the compressor process tube. (Note: Piercing devices must not be left on the system and must be replaced with a Schrader type valve.)

Evacuate/reclaim via the piecing pliers to ensure the system is empty of R-600a before any system work is performed.



The recovery cylinder must be evacuated (no air inside) prior to accepting R-600a.

The recovery cylinder must not be filled more than 45% safe fill level and refrigerants must not be mixed.

The recovery cylinder must be clearly marked with R-600a and Flammable Warning labels.

Ensure proper ventilation during recovery/reclaiming of R-600a.

Start vacuum pump/recovery pump prior to piercing the compressor process tube.

Follow recovery/reclaim OEM instructions for the specific equipment used.

SYSTEM REPAIR

Ensure no residual R-600a refrigerant is left within the system prior to repair (simple venting is not sufficient).

Evacuate and charge with dry nitrogen for leak checks.

Repair leaks or replace system parts as required.

When re-brazing, the system must be purged with dry nitrogen and at least one access point open to the atmosphere.

When re-brazing, proper ventilation is required along with constant monitoring for the presence of R600a refrigerant.

The filter dryer must be replaced any time the sealed system is serviced.

No system should be open to the atmosphere for longer than 15 minutes to avoid moisture migration into the system components.

LEAK DETECTION

After removal of the R-600a, the unit can be charged with dry nitrogen or helium.

Electronic leak detection or soap solution can be used to check for nitrogen/helium leaks.



Never use a halide torch or lighted match to check the system for leaks at any time.

The high side of the refrigeration system (compressor discharge to outlet of drier) must be leak tested with the compressor running.

The low side of the refrigeration system (evaporator, compressor and suction line) must be leak tested with the compressor off (equalized pressure).

RECHARGING

No air is ever to be allowed inside the refrigeration system (R-600a refrigerant or dry nitrogen only).

Never use a torch on a fully charged refrigeration system.

Install a Schrader Type access port on the compressor process stub.



Evacuate the system to 100 microns prior to charging.

Weigh in the R-600a charge using a refrigerant scale. (run compressor an extra two minutes to clear the charging hoses).

Seal the Schrader Type access port, a proper cap and seal must be used to close the system.



SUMMARY

Safely handling R-600a requires proper procedures and training.

R-600a approved service tools must be used.

R-600a labeling must not be removed or altered.

Proper ventilation during service is required.

Never apply a torch to a charged R-600a refrigeration system.

Use OEM replacement service parts and do not alter the construction of the unit.

System Diagnosis Guide

REGRIGERATION SYSTEM DIAGNOSIS GUIDE

System Condition	Suction Pressure	Suction Line	Compressor Discharge	Condenser	Capillary Tube	Evaporator	Wattage
Normal	Normal	Slightly below room temperature	Very hot	Very hot	Warm	Cold	Normal
Overcharge	Higher than normal	Very cold may frost heavily	Slightly warm to hot	Hot to warm	Cool	Cold	Higher than normal
Undercharge	Lower than normal	Warm-near room temperature	Hot	Warm	Warm	Extremely cold near inlet - Outlet below room temperature	Lower than normal
Partial Restriction	Somewhat lower than normal vacuum	Warm-near room temperature	Very hot	Top passes warm - Lower passes cool (near room temperature) due to liquid	Room temperature (cool) or colder	Extremely cold near inlet - Outlet below room temperature backing up	Lower than normal
Complete Restriction	In deep vacuum	Room temperature (cool)	Room temperature (cool)	Room temperature (cool)	Room temperature (cool)	No refrigeration	Lower than normal
No Gas	0 PSIG to 25"	Room temperature (cool)	Cool to hot	Room temperature (cool)	Room temperature (cool)	No refrigeration	Lower than normal

Control Operation-Service

UI BUTTON LAYOUT



1. **Hidden Button**
 -Access Service Menu
 -No LED directly above. All LEDs turn on with button
2. **Up Button**
 -Increases temperature
 -Navigates through service menu
3. **Down Button**
 -Decreases temperature
 -Navigates through service menu
4. **Light Button**
 -Activates light for 3 hours on select models
 -Used to select items in service menu
5. **Power Button**
 -Turns unit off/on
6. **Clean Button**
 -Activates Clean Cycle on select models
 -Toggles between zones in Dual-Zone models

CONTROL FUNCTION GUIDE

FUNCTION	COMMAND	DISPLAY/OPTIONS
ON/OFF	Press and release	Unit will immediately turn ON or OFF
Sabbath Mode	See "Sabbath Mode" section	

SHOWROOM MODE

This mode is designed to show units in a display environment. When in this mode the only functions will be the control and cabinet lights. The compressor, fans, etc. will not operate. To enter/exit this mode hold the light key and the power key for 5 seconds. The display will flash once and beep and the degree symbol will begin to flash. When the degree symbol is flashing the unit will allow the use of the control for demonstrations. The unit can be left in this mode indefinitely.

SERVICE MODE

This mode has options available for service diagnostics. To enter the mode hold the hidden key for 10 seconds. The display will show "0." When in this mode use the up and down arrows to select the desired option. The LIGHT key is the ENTER key and will initiate the function. If changing a setting, you must press the LIGHT key again to retain the changed setting. To exit the service mode scroll to option "0" and press the LIGHT key. After five minutes of not touching any keys the mode will also exit automatically.

Defrost

This unit defrosts every 4 hours of compressor runtime for 45 minutes. If you have verified that the unit does not have an ambient air leak, utilize the **Control Operation - Service** section and adjust unit to defrost every 3 hours for 60 minutes. Also, adjust the #2 thermistor to -4 instead of 0.

Remove Fan and Cover

CONVECTION COOLING

This unit is equipped with an advanced convection cooling system. Convection cooling stabilizes cabinet temperature, cools product faster and increases energy efficiency.

Evaporator Fan

The evaporator fan is responsible for circulating warm air from the refrigeration zone, past the evaporator and back into the refrigerated zone.

The evaporator fan is factory set to have a 1 minute delay at the beginning of a cooling cycle. This delay gives the evaporator time to cool properly before warm air is passed over it. The fan will continue to run for an additional 2 minutes at the end of a cooling cycle. Fan delay times can be modified through the service menu.

Evaporator fan operation is also determined by door switch state. If the door switch circuit opens, the fan will stop. When the door switch circuit is closed the fan will either continue running with the cooling cycle, or if not currently cooling, the fan will run for 1 minute to circulate air and clear any condensation that may have appeared on glass doors and shelves.

Note: If the unit is set to sabbath mode, the evaporator fan will no longer respond to the state of the door switch.

In order to operate efficiently, the evaporator fan blade and vents should be unobstructed and free of any dust buildup.

Evaporator Fan Replacement

Should the evaporator fan need to be replaced follow the steps below.

1. Remove any product from the unit.
2. Remove unit from cabinetry to access rear.
3. Disconnect power to the unit.
4. Remove back panel from unit.
5. Disconnect fan electrical connection at rear of unit.

6. Remove insulating foam from refrigerant line pass-through hole as needed to gain clearance for fan plug.
7. Remove internal shelving.
8. Remove evaporator cover screws.

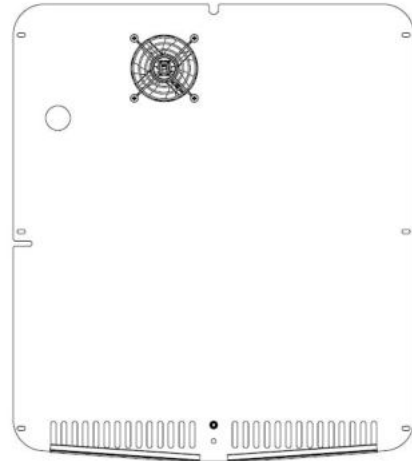

9. Grasp evaporator cover, pull forward and up as bottom of cover is installed behind the front edge of the drain trough.
10. While pulling the evaporator cover clear of the unit, it may be necessary to use your free hand to manipulate the fan plug end through the pass-through hole.
11. Remove the 4 screws mounting the fan shroud to the evaporator plate.

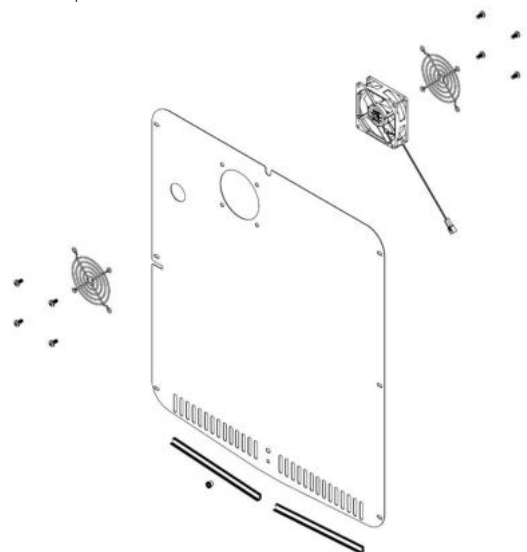

12. Remove and replace fan. Take special care to properly route fan wire.

NOTICE

Fan must be oriented to pull air in through lower evaporator cover vents and push air out at fan mounting location.

13. Installation is the reverse of removal.
14. Care must be taken to assure the bottom of the evaporator cover is reinstalled behind the front edge of the train trough.
15. Use sealant gum to seal any openings at rear of unit before replacing rear cover.
16. Reinstall unit taking care to level, space and secure as found.

HOUSEHOLD PRODUCT WARRANTY

Marvel Refrigeration (Marvel) Limited Warranty

ONE YEAR LIMITED PARTS & LABOR WARRANTY

For one year from the date of original purchase, this warranty covers all parts and labor to repair or replace any part of the product that proves to be defective in materials or workmanship. For products installed and used for normal residential use, material cosmetic defects are included in this warranty, with coverage limited to 60 days from the date of original purchase. All service provided by Marvel under the above warranty must be performed by a Marvel factory authorized servicer, unless otherwise specified by Marvel. Service provided during normal business hours.

TWO YEAR LIMITED PARTS & LABOR WARRANTY (MARVEL PROFESSIONAL PRODUCTS)

For two years from the date of original purchase, this warranty covers all parts and labor to repair or replace any part of the product that proves to be defective in materials or workmanship. For products installed and used for normal residential use, material cosmetic defects are included in this warranty, with coverage limited to 60 days from the date of original purchase. All service provided by Marvel under the above warranty must be performed by a Marvel factory authorized servicer, unless otherwise specified by Marvel. Service provided during normal business hours.

AVAILABLE THIRD YEAR LIMITED WARRANTY (MARVEL PROFESSIONAL PRODUCTS)

For designated Marvel Professional product, Marvel offers a one year extension of the two year warranty coverage from the date of purchase, free of charge. To take advantage of this third year warranty, you must register your product with Marvel within 60 days from the date of purchase at marvelrefrigeration.com and provide proof of purchase. Nugget Ice Machine proof of purchase must include the purchase of an in-line water filter and filter head to qualify for this additional limited warranty.

LIMITED FIVE YEAR SEALED SYSTEM WARRANTY

For five years from the date of original purchase, Marvel will repair or replace the following parts, labor not included, that prove to be defective in materials or workmanship: compressor, condenser, evaporator, drier, and all connecting tubing. All service provided by Marvel under the above warranty must be performed by a Marvel factory authorized servicer, unless otherwise specified by Marvel. Service provided during normal business hours.

WARRANTY TERMS

These warranties apply only to products installed in any one of the fifty states of the United States, the District of Columbia, or the ten provinces of Canada. The warranties do not cover any parts or labor to correct any defect caused by negligence, accident or improper use, maintenance, installation, service, repair, acts of God, fire, flood or other natural disasters. The product must be installed, operated, and maintained in accordance with the Marvel User Guide.

The remedies described above for each warranty are the only ones that Marvel will provide, either under these warranties or under any warranty arising by operation of law. Marvel will not be responsible for any consequential or incidental damages arising from the breach of these warranties or any other warranty, whether express, implied, or statutory. Some states do not allow the exclusion or limitation of incidental or consequential damages, so the above limitation or exclusion may not apply to you. These warranties give you specific legal rights, and you may also have other rights which vary from state to state.

Any warranty that may be implied in connection with your purchase or use of the product, including any warranty of merchantability or any warranty fit for a particular purpose is limited to the duration of these warranties, and only extends to five years in duration for the parts described in the section related to the five year limited warranty above. Some states do not allow limitations on how long an implied warranty lasts, so the above limitations may not apply to you.

- The warranties only apply to the original purchaser and are non-transferable.
- These warranties cover products installed and used for normal residential use only.
- The warranties apply to units operated outside only if designed for outdoor use by model and serial number.
- Replacement water filters, light bulbs, and other consumable parts are not covered by these warranties.
- The start of Marvel's obligation is limited to four years after the shipment date from Marvel.
- In-home instruction on how to use your product is not covered by these warranties.
- Food, beverage, and medicine loss are not covered by these warranties.
- If the product is located in an area where Marvel factory authorized service is not available, you may be responsible for a trip charge or you may be required to bring the product to a Marvel factory authorized service location at your own cost and expense.
- Units purchased after use as floor displays, and/or certified reconditioned units, are covered by the limited one year warranty only and no coverage is provided for cosmetic defects.
- Signal issues related to Wi-Fi connectivity are not covered by these warranties.

For parts and service assistance, or to find Marvel factory authorized service near you, contact Marvel Refrigeration:

MarvelRefrigeration.com • techsupport@MarvelRefrigeration.com • +616.754.5601

1260 E. Van Deine St., Greenville, MI 48838



www.marvelrefrigeration.com

Marvel Refrigeration

1260 E. Van Deinse St.
Greenville MI 48838

616.754.5601

41015651 Rev A
12/14/20

All specifications and product designs subject to change without notice. Such revisions do not entitle the buyer to corresponding changes, improvements, additions, replacements or compensation for previously purchased products.