

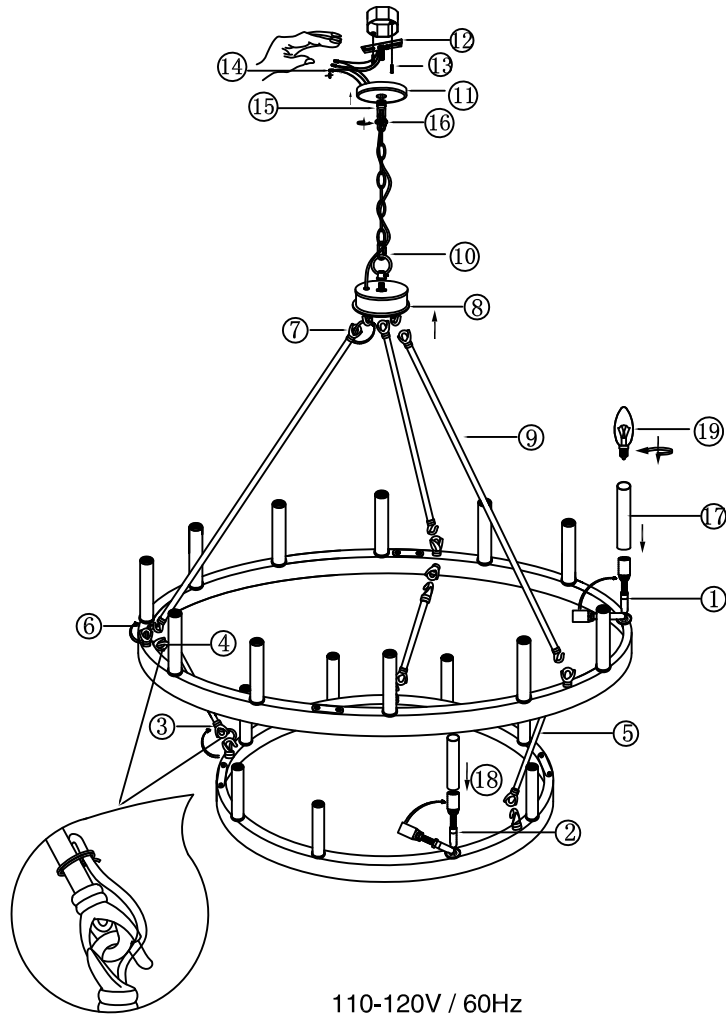







FIXTURE ASSEMBLY STEPS:

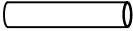

110-120V / 60Hz
 E12 (12+8)*MAX 60W TYPE B
 (Do not contain light bulb)

DESCRIPTION	PICTURE	CODE	QTY
Mounting Plate		12	1 SET
Mounting Screw		13	2 PCS
P3 Wiring cap		14	3 PCS
Drivepipe		17	20 PCS
Canopy		11	1 PCS
Black Cable tie			3 PCS
Chain +Flying rings + movable chain link		10 / 15 / 16	1 SET
Derrick Part (A#)		9	2 PCS
Derrick Part (B#)		5	2 PCS
Lamp Body		1 / 2 / 3 / 4 / 6 / 7 / 8	1 SET
			
			

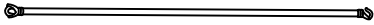
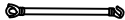
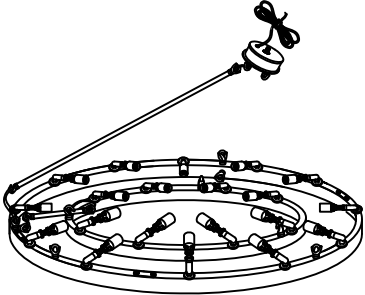
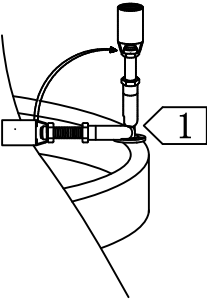
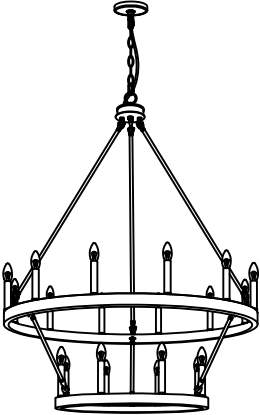
WARNING - if any Special Control Devices are used with this Fixture, Follow the instructions Carefully to assure fun compliance With N.E.C. requirements. if there are any questions, contact a Qualified Electrical Contractor.
CAUTION - All glass is fragile, use care when handling Glass component(s) and or Lamp(s).
WARNING - This product contains chemicals known to the State of California to cause cancer, birth defects and /or other reproductive harm. Thoroughly wash hands after installing. handling. cleaning, or otherwise touching this product

CANOPY MOUNTING & WIRE CONNECTION ASSEMBLY STEPS:

Attach(N),(P) to achieve overall desired length.
 Una (N),(P) para lograr la longitud deseada.
 Joignez(N),(P) pour obtenir la Longueur voulue.

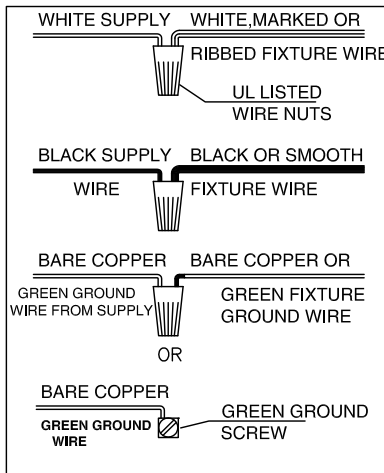

FIXTURE ASSEMBLY STEPS:

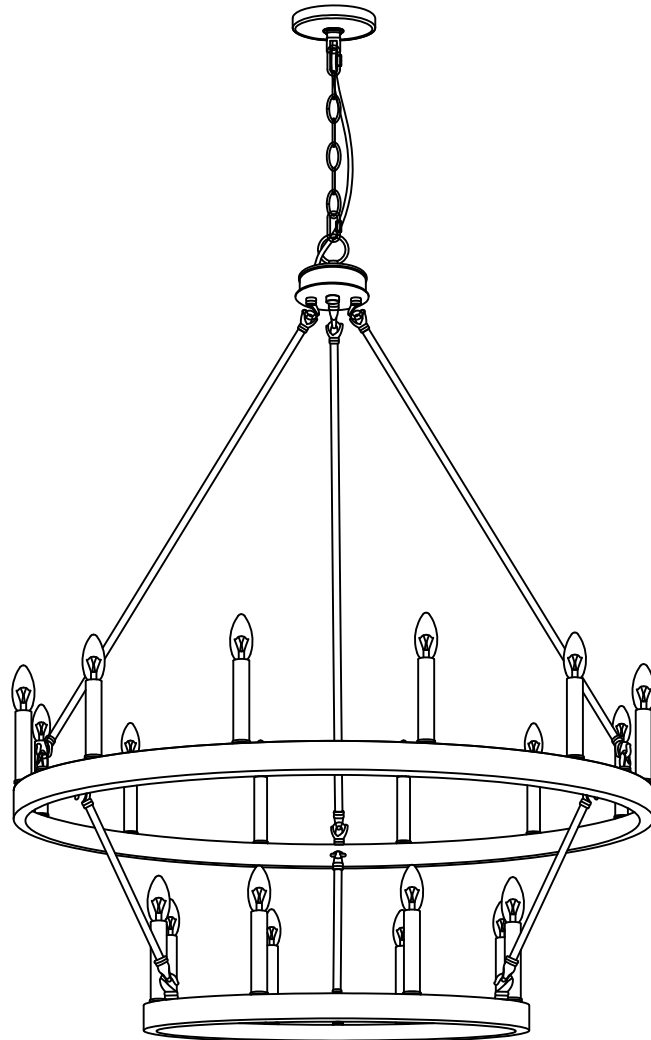

110-120V / 60Hz
 E12 (12+8)*MAX 60W TYPE B
 (Do not contain light bulb)

1. AC110~120V,50~60Hz.The Max lamps power is 60W TYPE B Bulb.
2. Avoid to scratch the surface of lighting and the wires when install it.
3. Connect the live wire with the white wire, the natural wire with the parti-colored one, the earth one with the earth symbol (L-L,N-N).
4. Don't install it to the ceiling before it's completely dry, the surrounding around must be ventilated and dry.
5. Keep away from the acid, basicity objects and gases, clean with soft cloth, water washing is not allowed.
6. Be careful when you install glass lamp shade
7. The lighting must be installed by professional electrician and used indoor only.
8. Please keep attention to cut off the power supply when installing, cleaning, and replacing bulb.

FIXTURE ASSEMBLY STEPS:

