

CHICKEN COOP

2.75X4 M
9X13 FT

ASSEMBLY INSTRUCTIONS

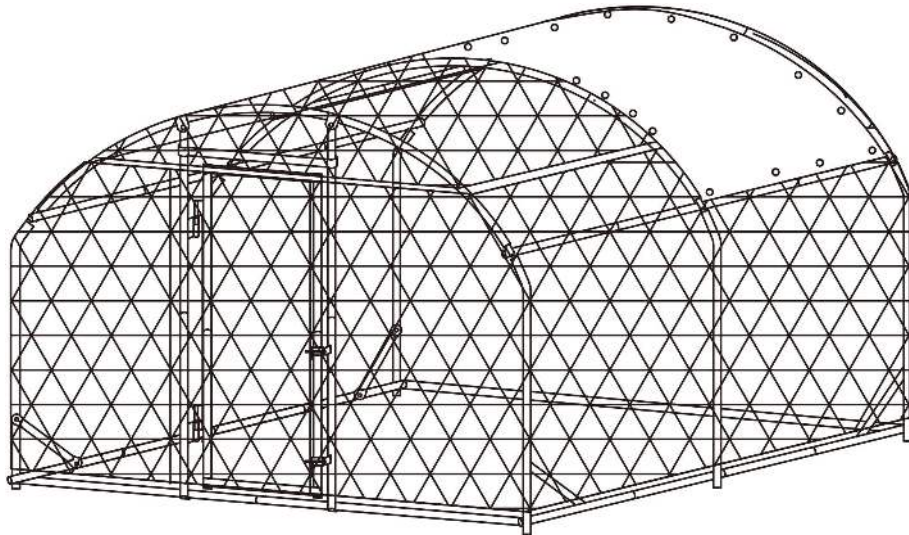

TOOLS RECOMMENDED

*NOTE: The recommended tools are not included in boxes and need to be prepared by yourself.



DRILL



RUBBER Mallet



STEPLADDER
(6.5Ft Or More)



SAFETY HAT



GLOVES



SAFETY GOGGLES

⚠ ATTENTIONS



Two or more people are required for assembly



To better align the screws for practical situations, do not fully tighten screws initially



Please reinforced the Gazebo and do not use in heavy winds or inclement weather



Make sure all screws are tightened before use and check all screws, buckles and straps every 90 days











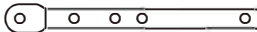

Since it is easy to lose many small accessories during the installation, please collect all the screw accessories before the assembly is completed

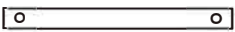
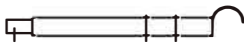
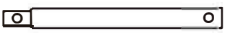
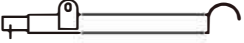
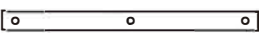
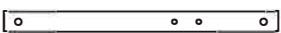
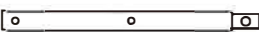





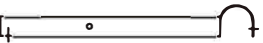





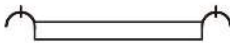



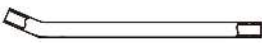

Please clear the snow off the roof in time for the heavy snowfall and do not use it

ACCESSORY CATALOGUE

BOX

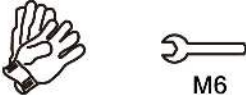
Item no.	Reference Image	Qty.	Item no.	Reference Image	Qty.
1		3	5		1
1A		3	5A		1
2		3	6		1
2A		13	6A		1
2B		2	7		1
2C		2	7A		1
3		4	8		1
4		2	8A		1
4A		2	10		1

ACCESSORY CATALOGUE

Item no.	Reference Image	Qty.	Item no.	Reference Image	Qty.
11		2	I		1
12		4	J		4
12A		2	K		4
D		2	L		12
E		22	M	 M6X55mm	11
F		200	N	 M6X30mm	26
G	 M6	2	O	 M6X25mm	2
H		2	P	 M6X55mm	4

STEP 1

Parts required

 **2** 3pcs

 **2C** 2pcs

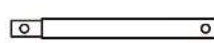

 **2A** 13pcs

 **2B** 2pcs

N 10pcs

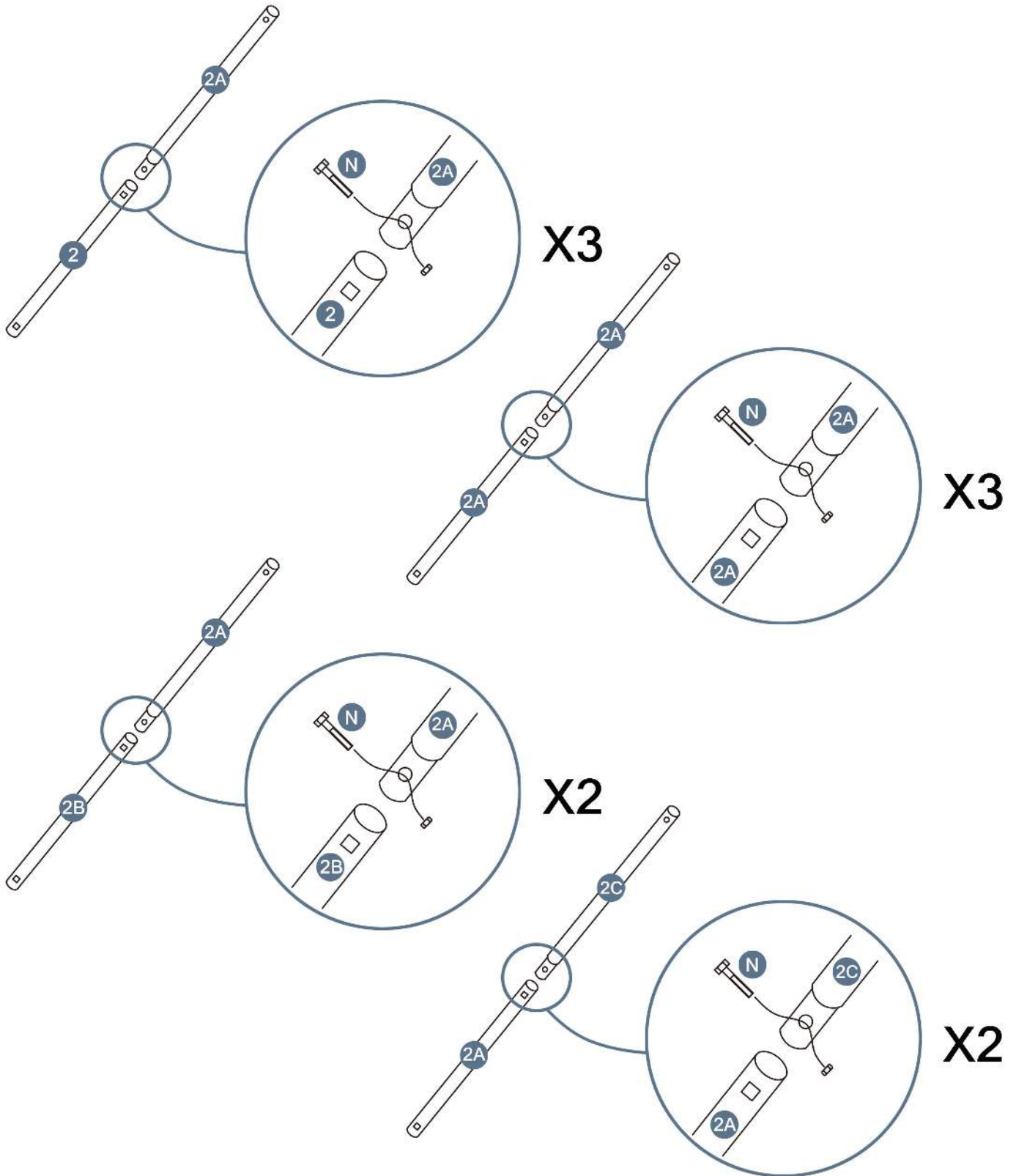

STEP 2

Parts required



1 3pcs

1A 3pcs



M 3pcs

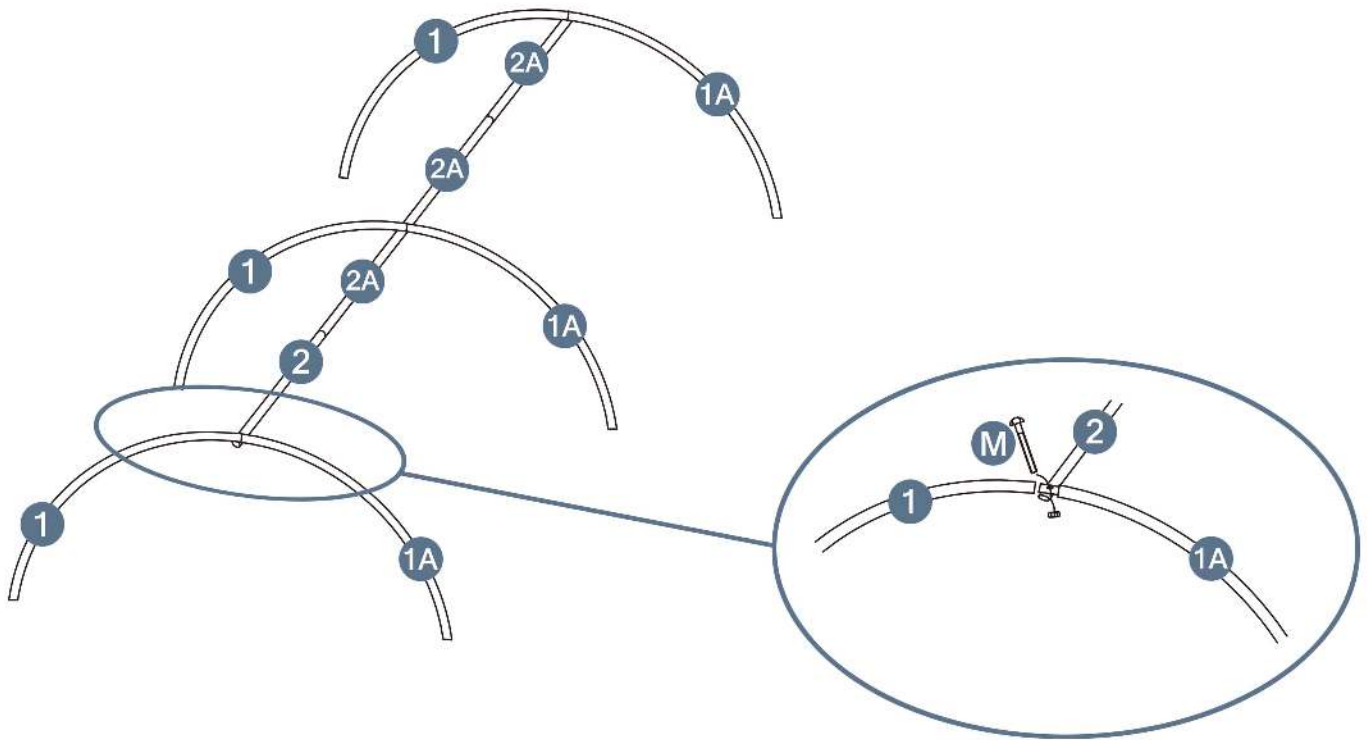

STEP 3

Parts required

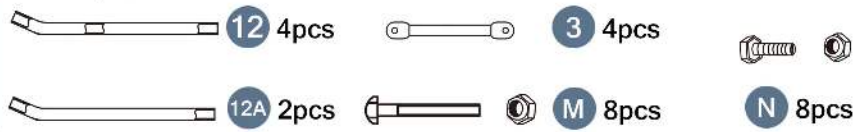

⚠ Pay attention to the differences in screws.

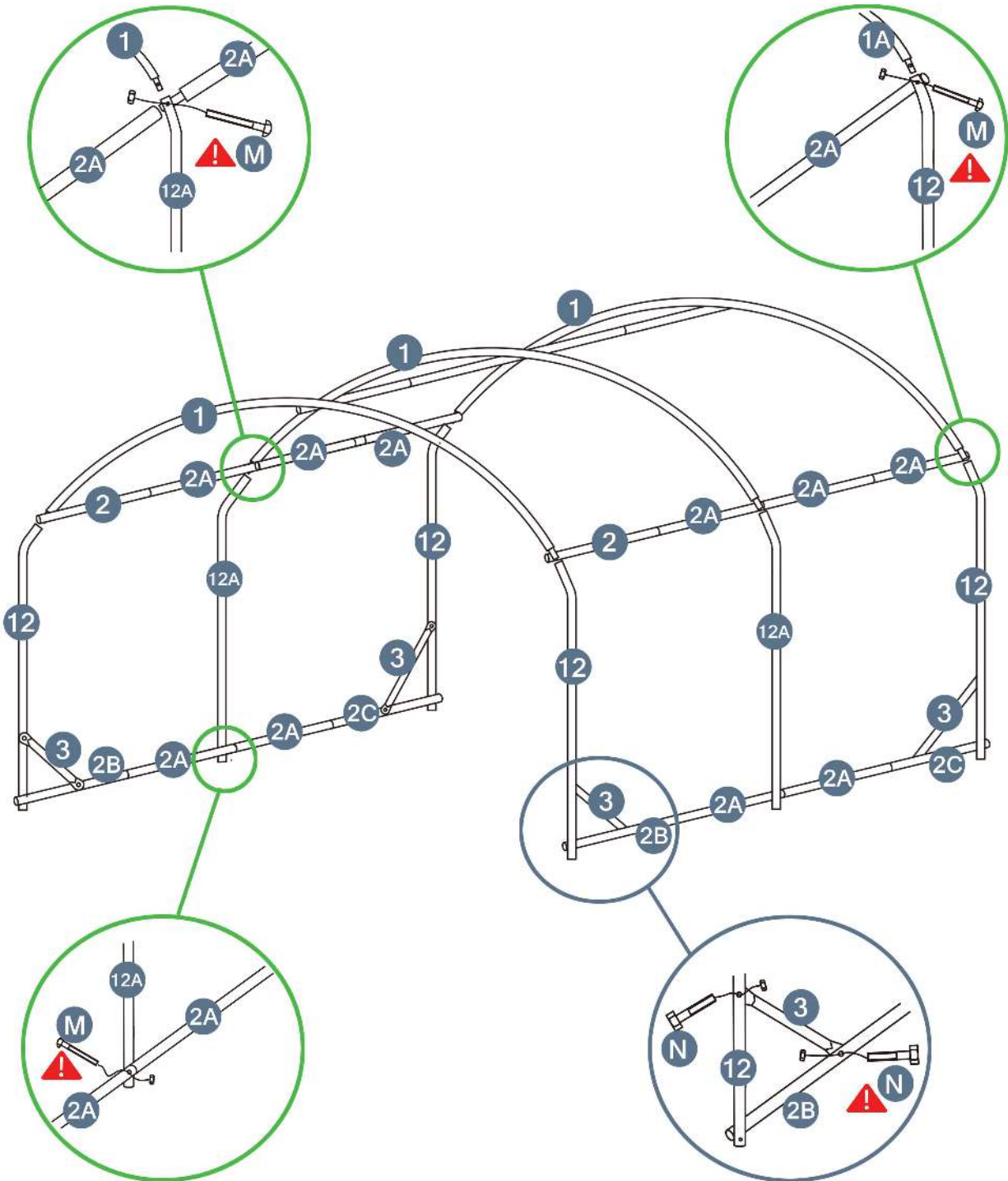

STEP 4

Parts required

 4 2pcs

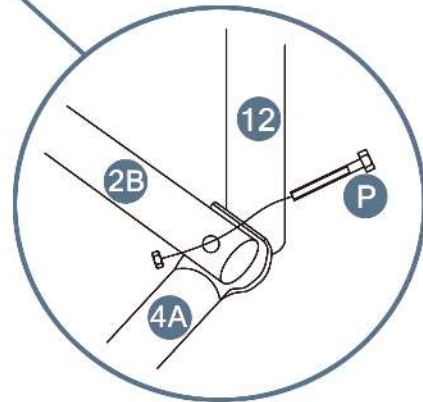
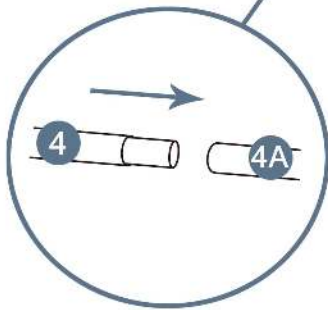
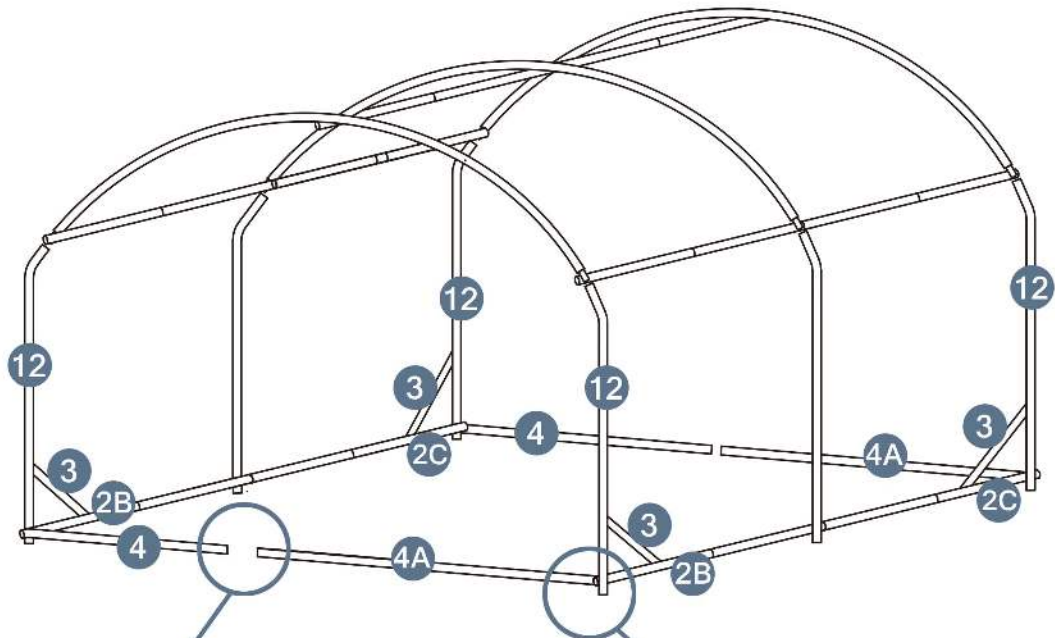

 4A 2pcs

 P 4pcs



STEP 5

Parts required

- 7 1pcs 11 2pcs 8A 1pcs
7A 1pcs 8 1pcs   N 4pcs

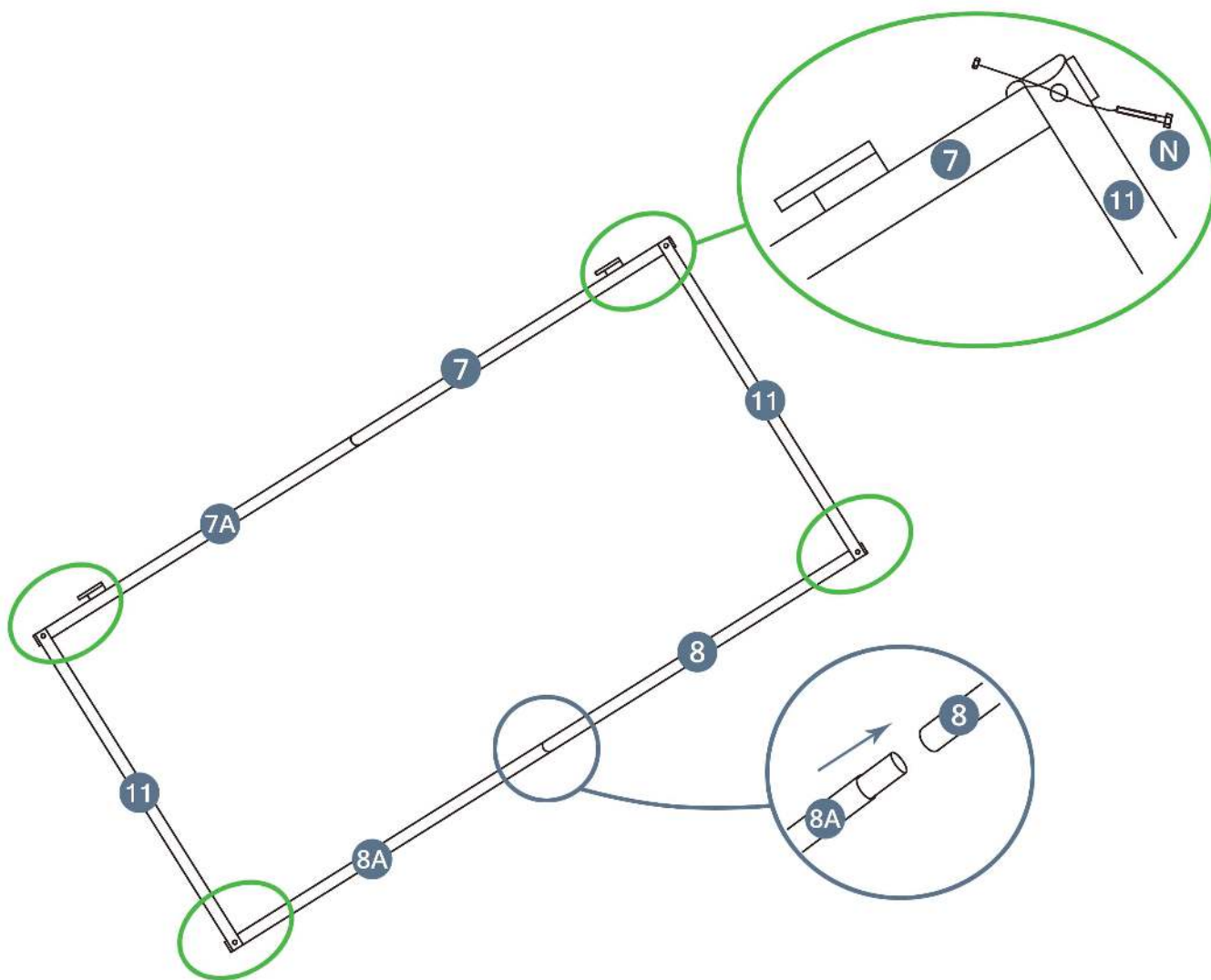

STEP 6

Parts required

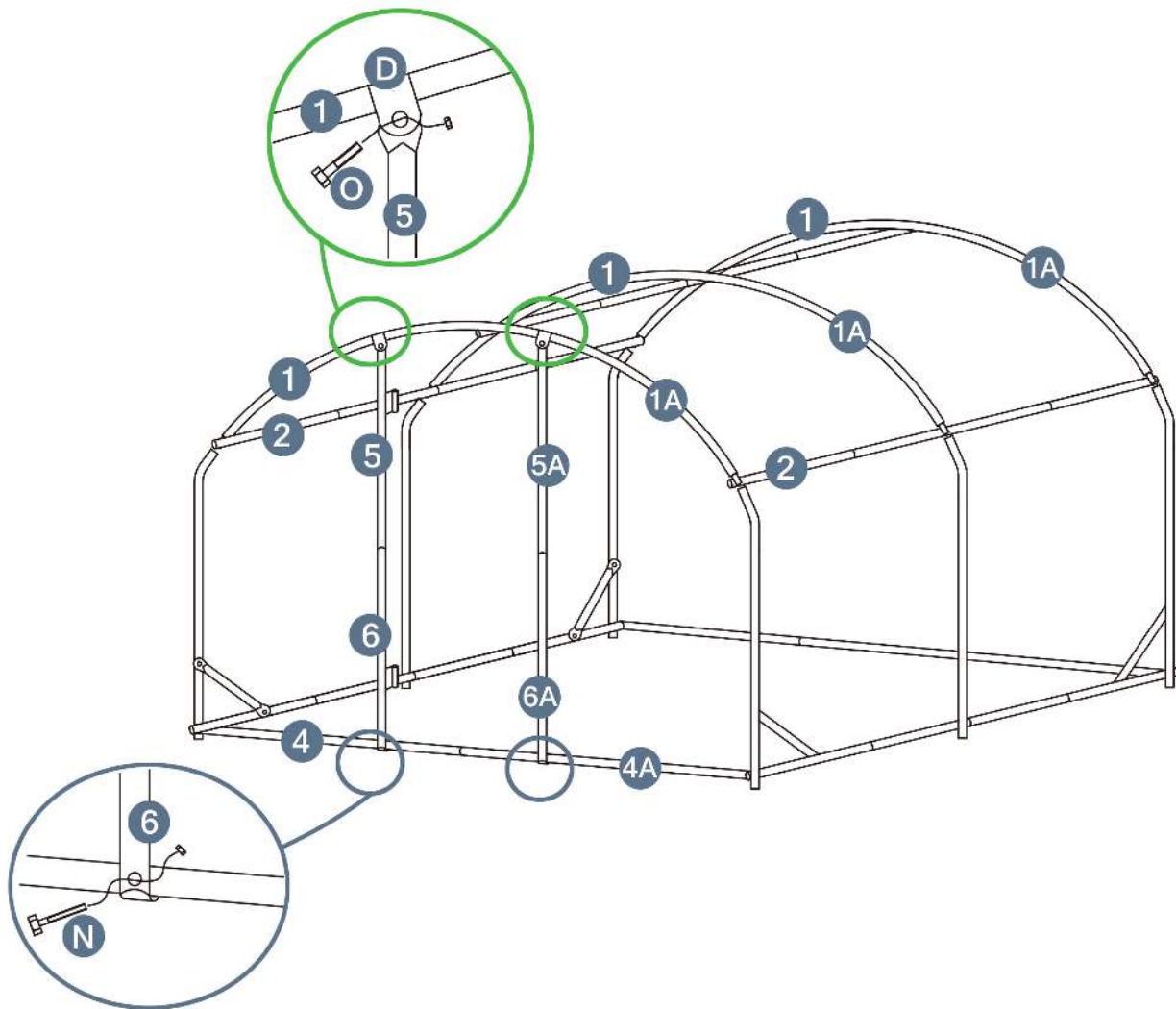
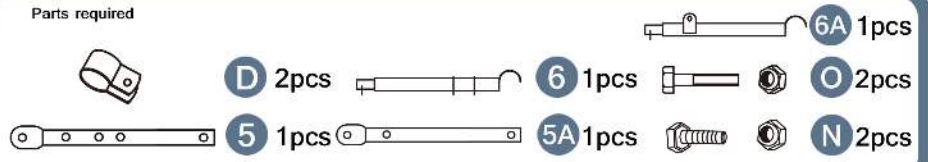

STEP 7

Parts required

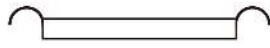

10 1pcs



N 2pcs

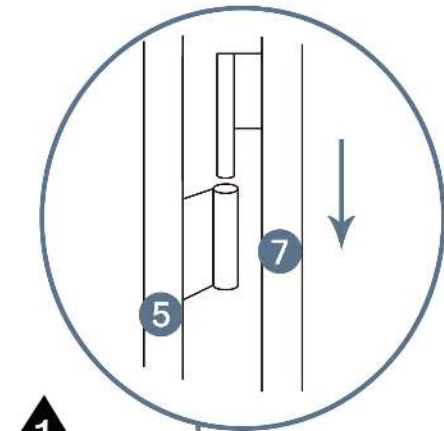

1

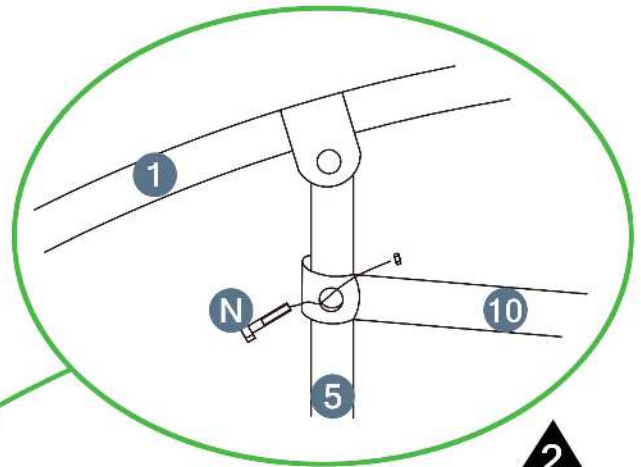

2

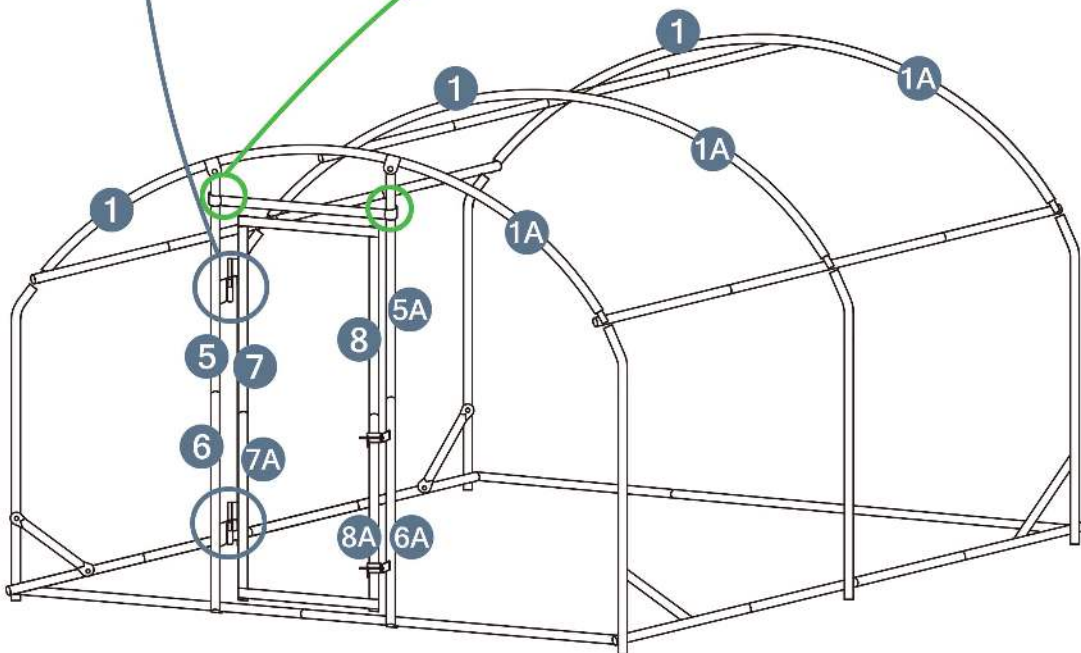

STEP 8

Parts required



H 1pcs



F 100pcs

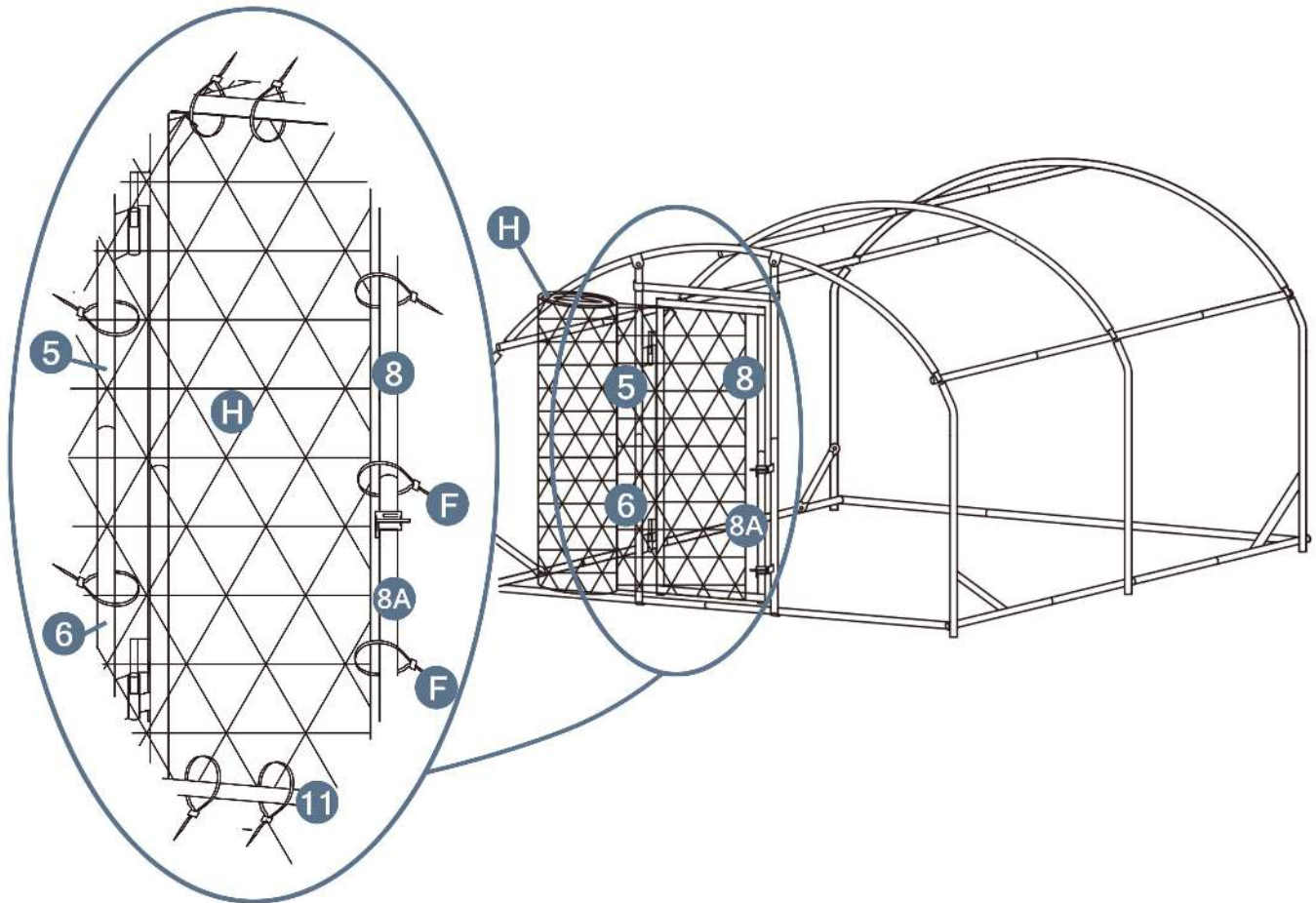

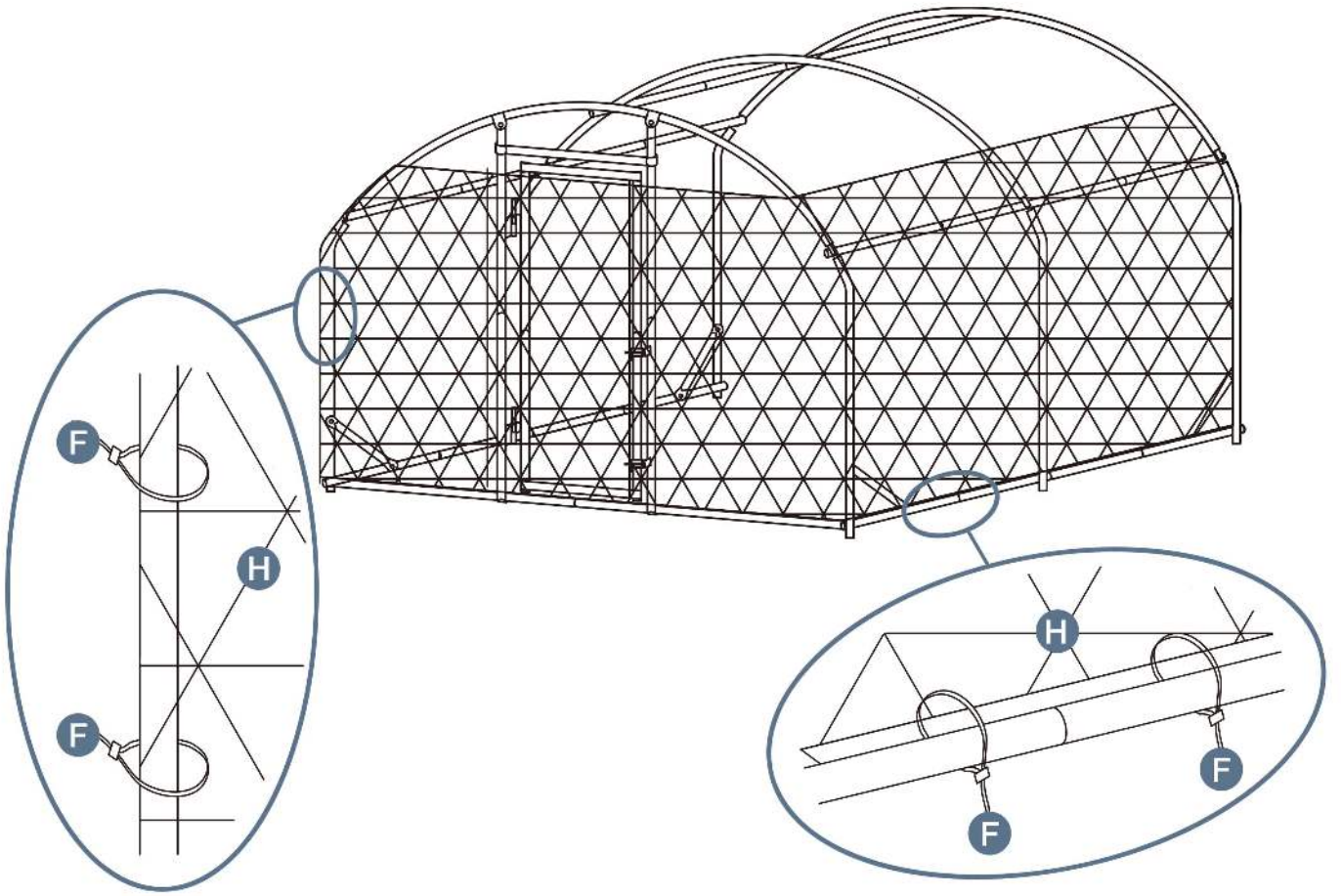

STEP 9

Parts required

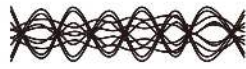

H 1pcs



F 100pcs

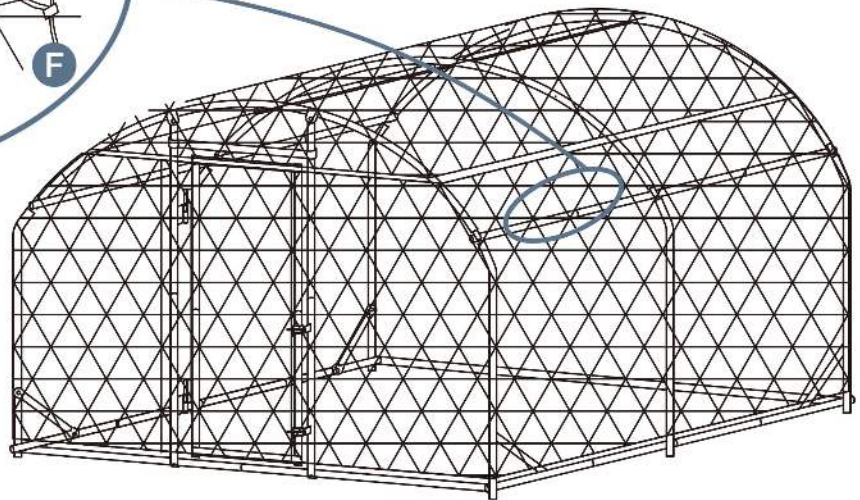
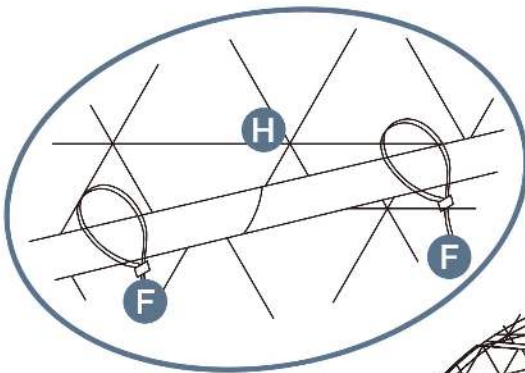
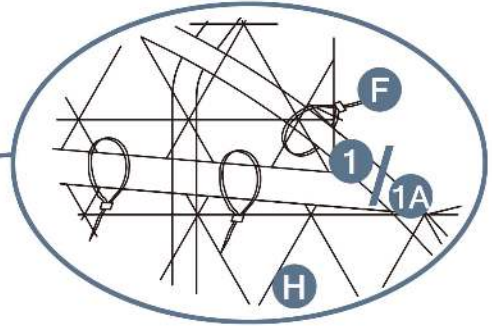
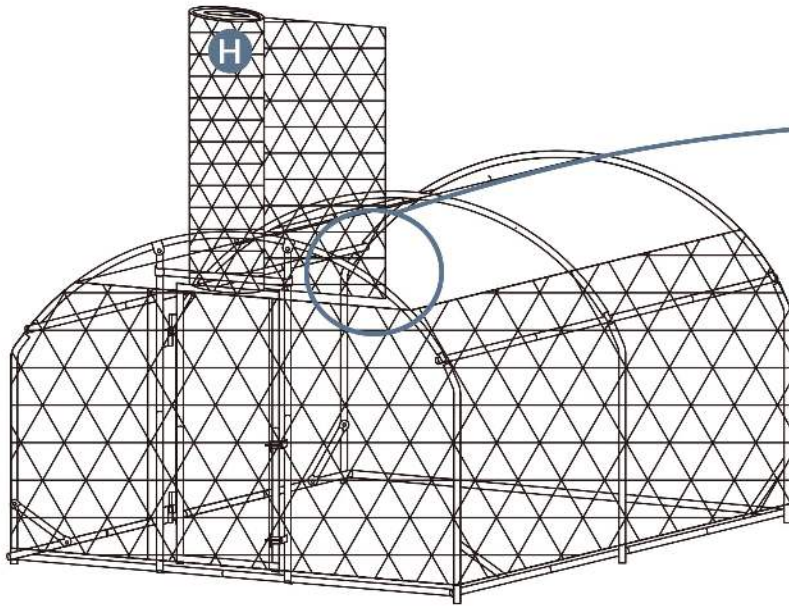

STEP 10

Parts required



I 1pcs



E 22pcs

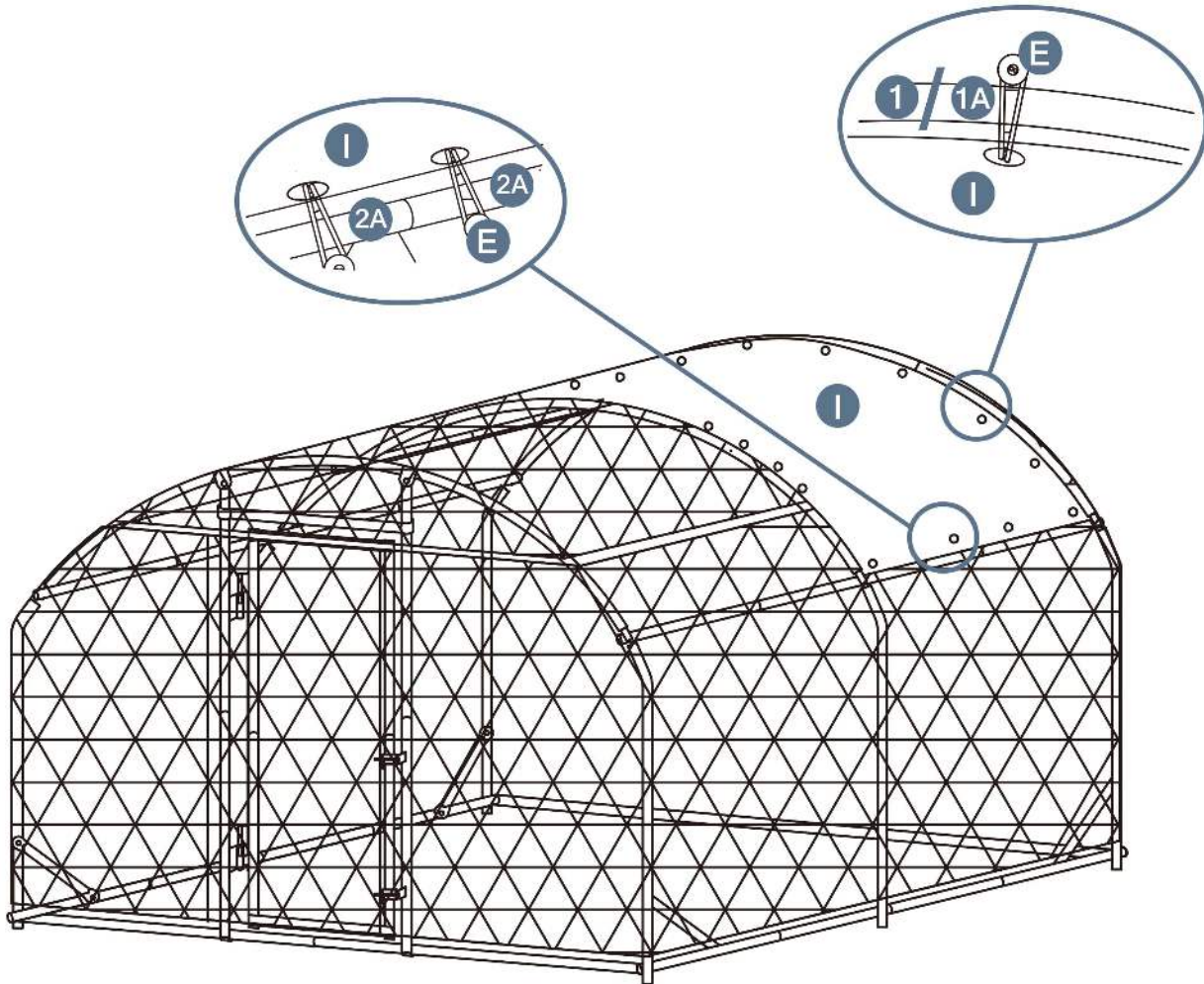

STEP 11

Parts required

 **K** 4pcs  **J** 4pcs  **L** 12pcs

