

# Installation Manual

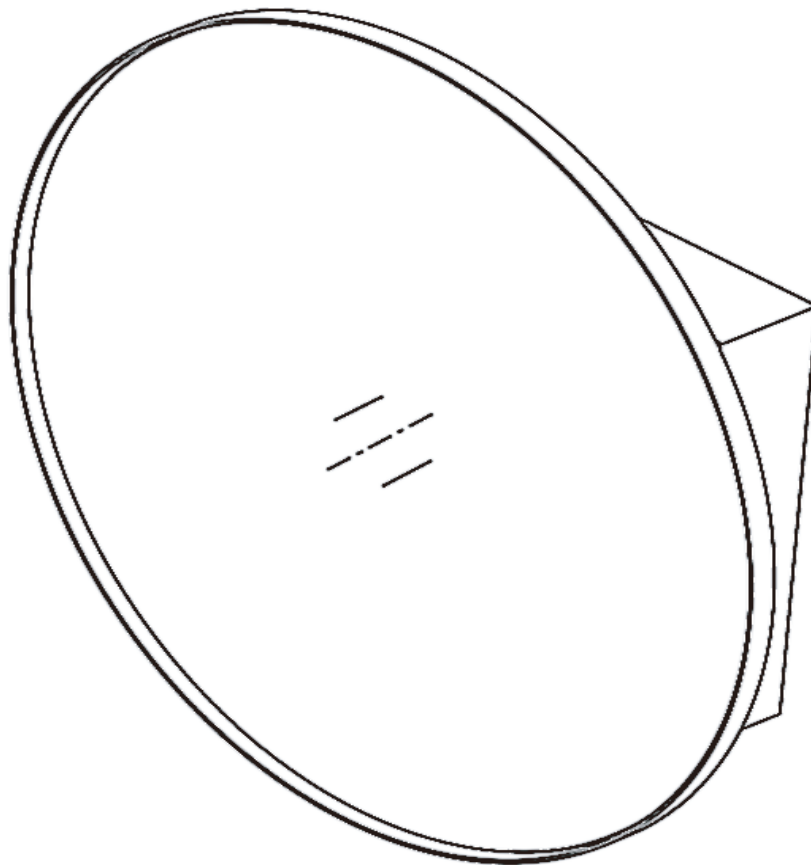



## **Medicine Cabinet with Mirror**

# INDEX

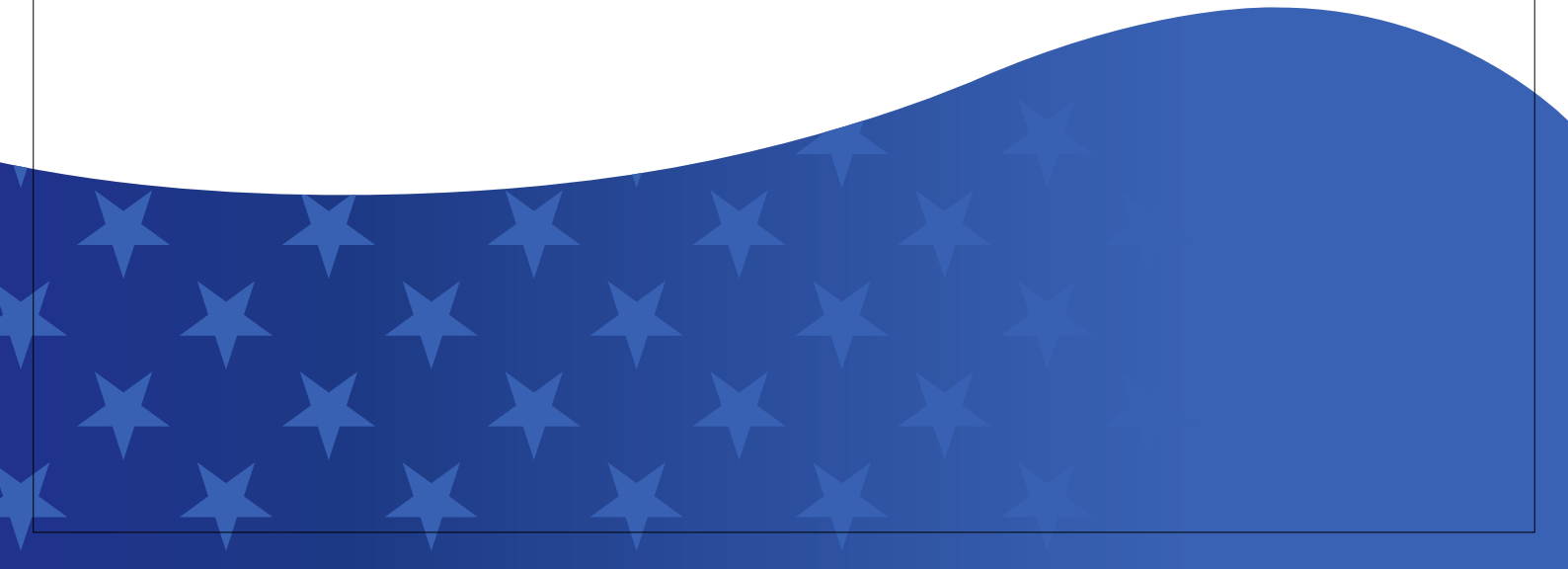
1. Installation Preparation .....	P01
2. Installation Instruction .....	P02-03

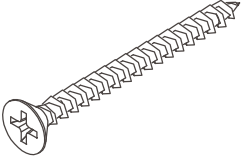
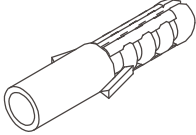
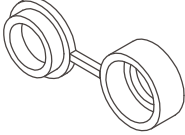

# List of Parts

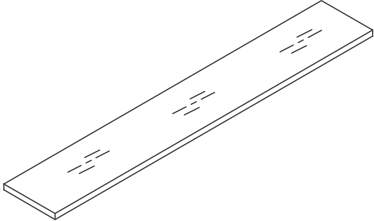
<p>A <span style="float: right;">4pcs</span></p>  <p style="text-align: center;">Screws</p>	<p>B <span style="float: right;">4pcs</span></p>  <p style="text-align: center;">Rubber plug screws</p>	<p>C <span style="float: right;">4pcs</span></p>  <p style="text-align: center;">Screw cover</p>
<p>D <span style="float: right;">4pcs</span></p>  <p style="text-align: center;">Screw washers</p>	<p>E <span style="float: right;">4pcs</span></p>  <p style="text-align: center;">Rubber mat</p>	<p>F <span style="float: right;">2pcs</span></p>  <p style="text-align: center;">Glass shelf</p>

Please make sure all the parts are included.  
 Missing parts? Reach out to Contact us for free replacement

## Additional Tools Required

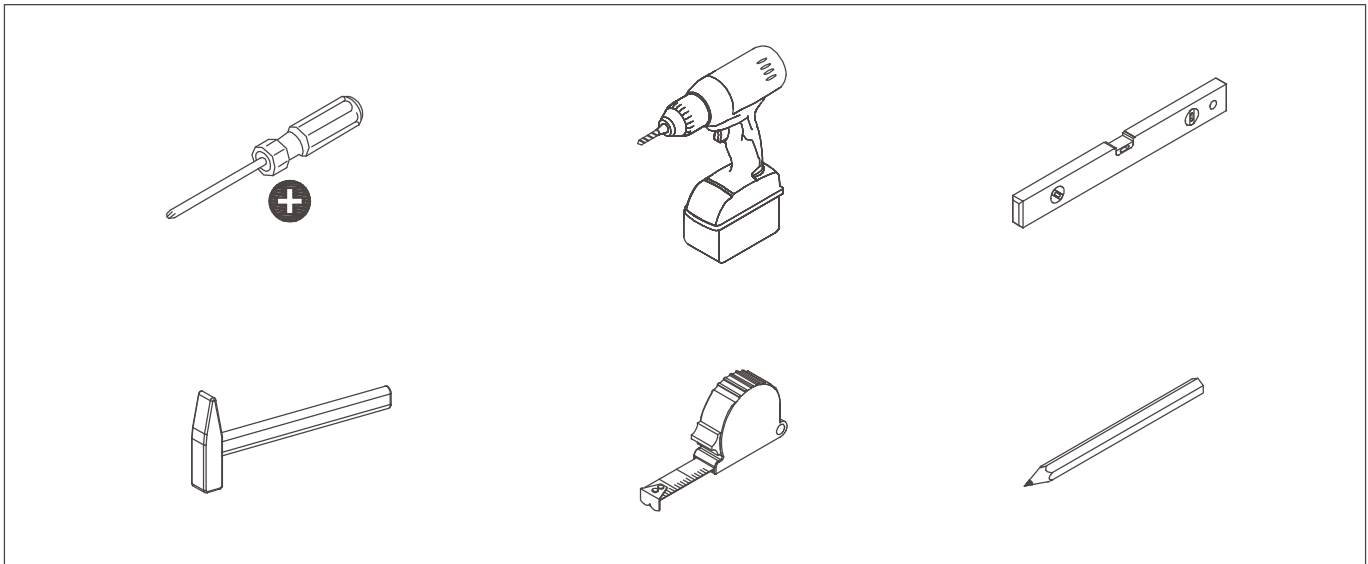

# Surface installation

Mark four (4) mounting holes on the wall corresponding to the pre-drilled hole locations in the mounting bars on the inside back panel of the cabinet.

