

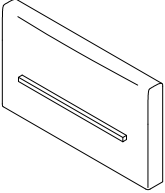

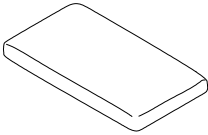

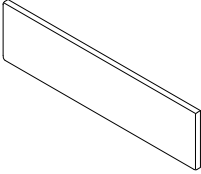
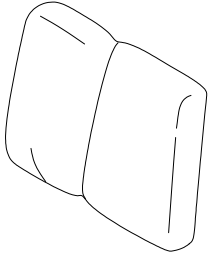
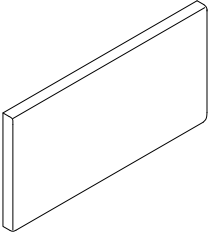
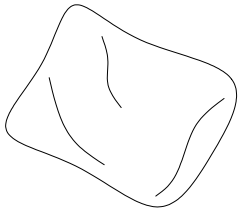
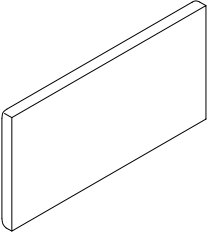
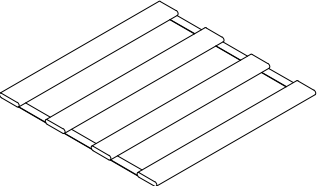
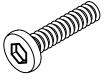

Y201G

Item no. Nr. N.º d'article Articolo No. Artículo No.	Reference Image Referenzbild Image de reference Immagine di riferimento Imagen de referencia	Qty. Menge Qte. Qta Cant.	Item no. Nr. N.º d'article Articolo No. Artículo No.	Reference Image Referenzbild Image de reference Immagine di riferimento Imagen de referencia	Qty. Menge Qte. Qta Cant.
1		X1	6		X1
2		X1	7		X2
3		X1	8		X1
4		X1			
5		X2			

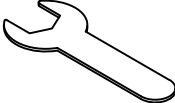
Item no. Nr. N.º d'article Articolo No. Articulo No.	Reference Image Referenzbild Image de reference Immagine di riferimento Imagen de referencia	Qty. Menge Qte. Qta Cant.	Item no. Nr. N.º d'article Articolo No. Articulo No.	Reference Image Referenzbild Image de reference Immagine di riferimento Imagen de referencia	Qty. Menge Qte. Qta Cant.
<b>A</b>	 M6*20	X26	<b>J</b>	 4mm	X1
<b>B</b>	 M8	X2	<b>K</b>		X1
<b>C</b>		X28			
<b>D</b>		X4			
<b>E</b>		X4			
<b>F</b>		X2			
<b>G</b>		X2			
<b>H</b>	 5*20	X2			

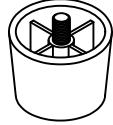
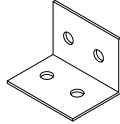

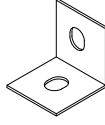
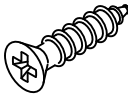
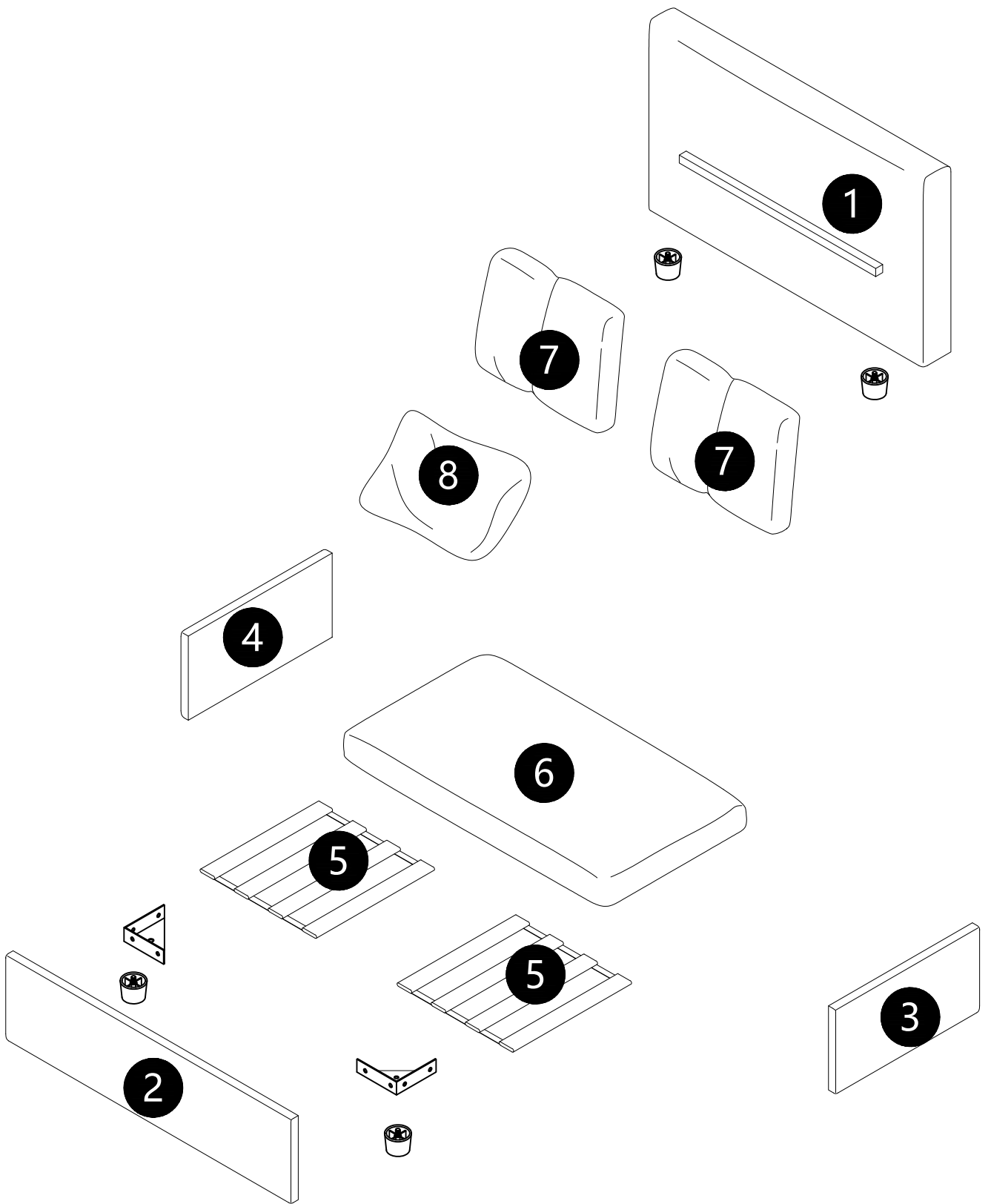
1

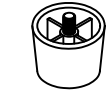

D x 2

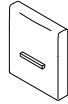

1 x 1

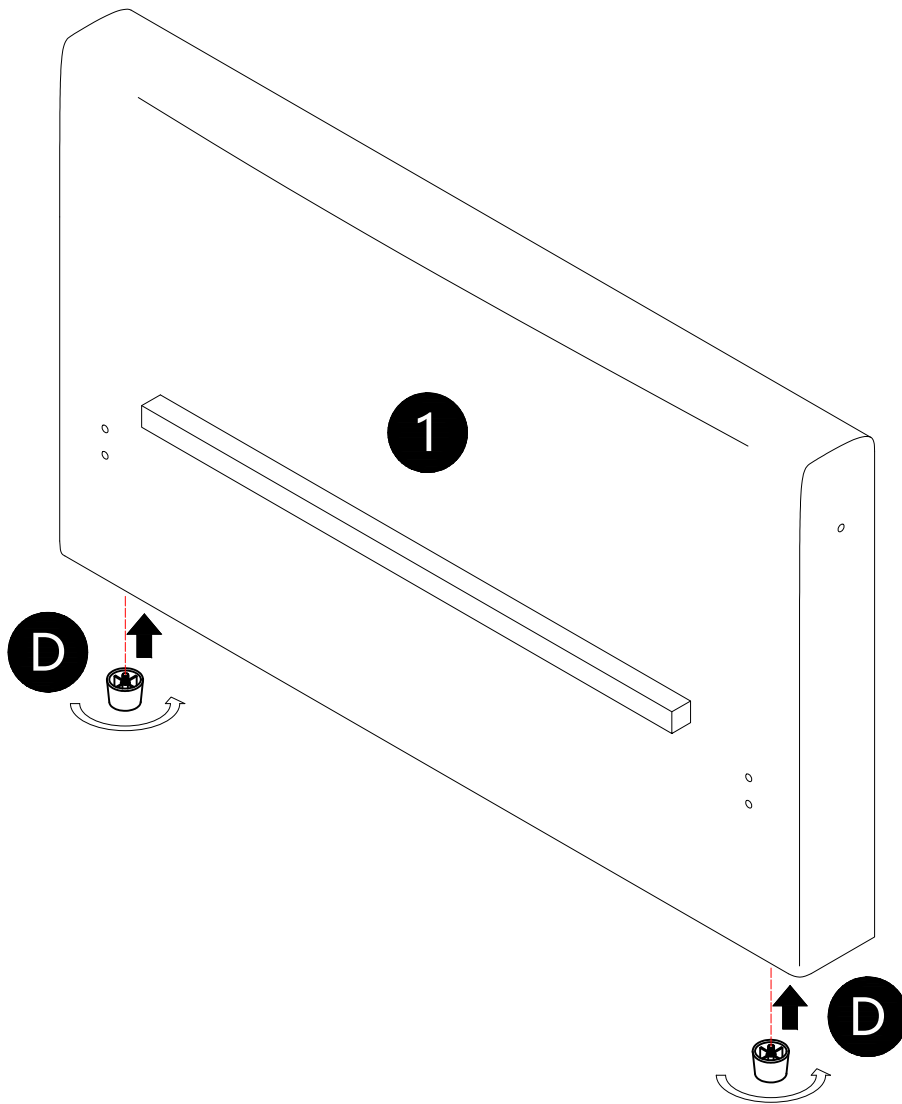

# 2

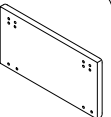
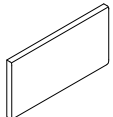
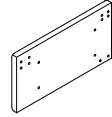
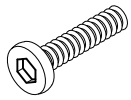

A x 16

B x 2

C x 16

D x 2

E x 2

J x 1

F x 2

3 x 1

4 x 1

2 x 1

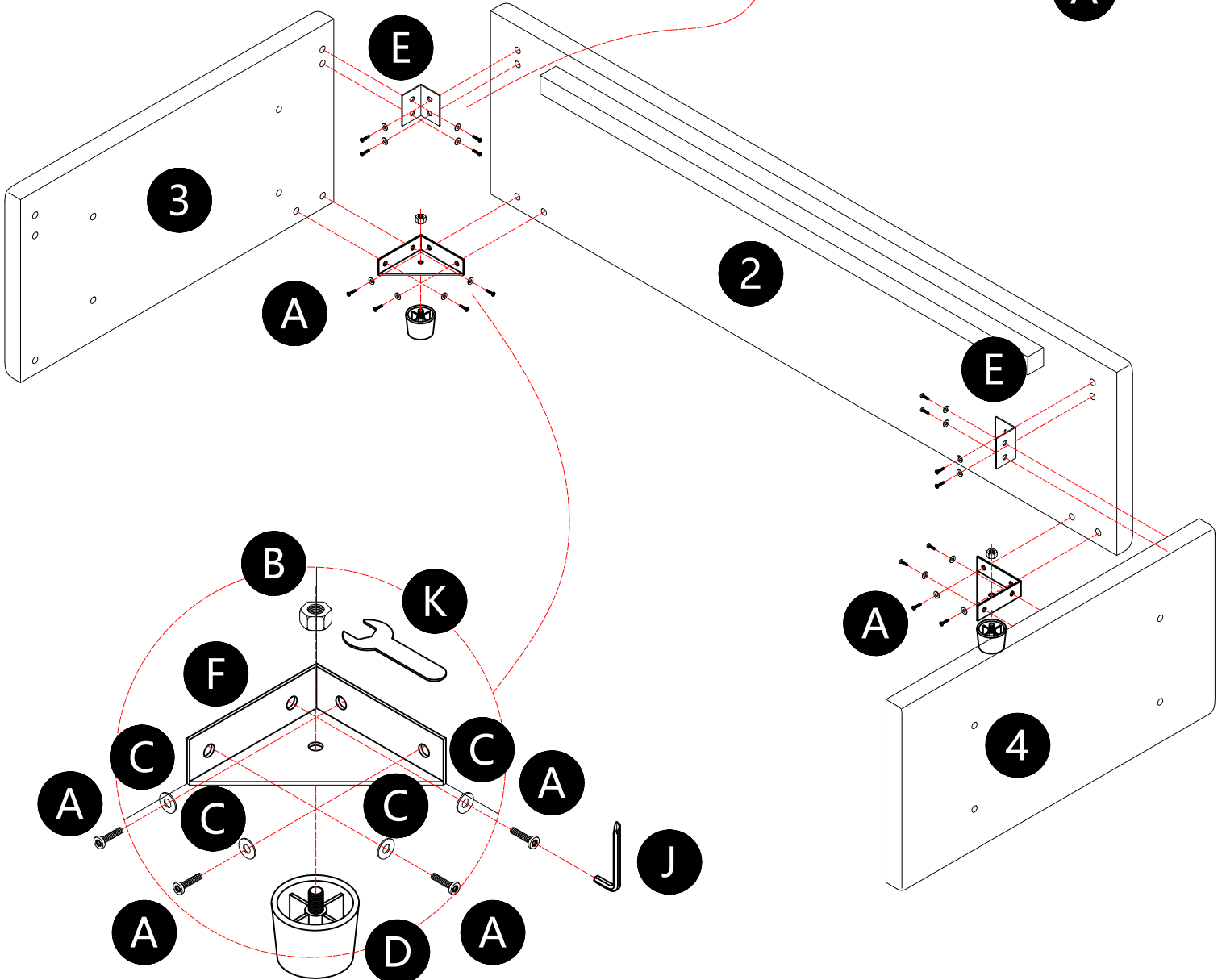
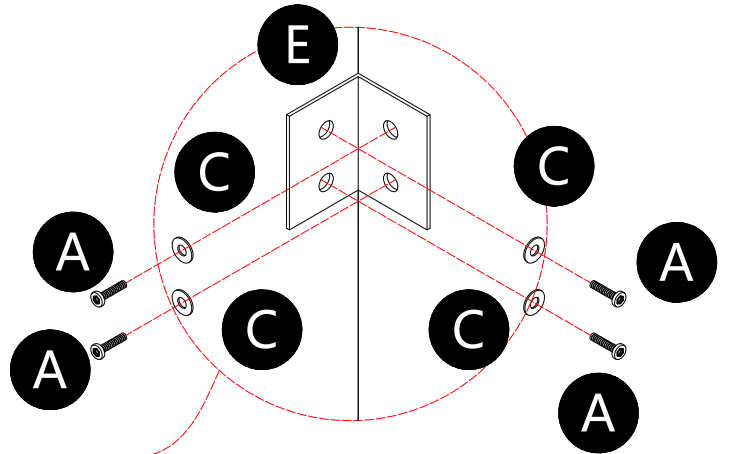

# 3

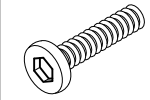

A x 10



C x 12



E x 2



G x 2



J x 1



H x 2

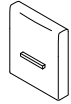

1 x 1

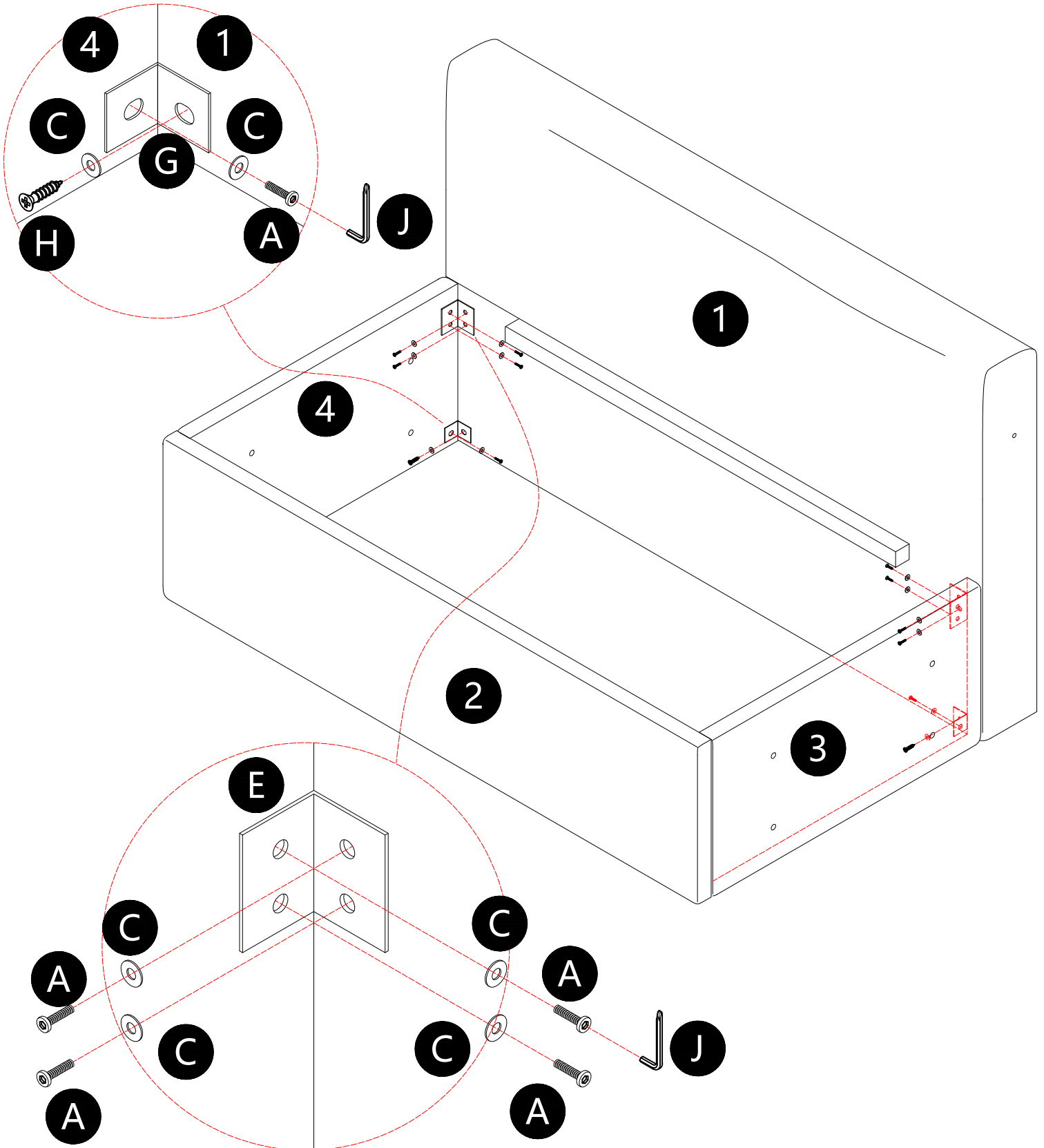

4

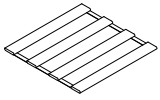

5 x 2

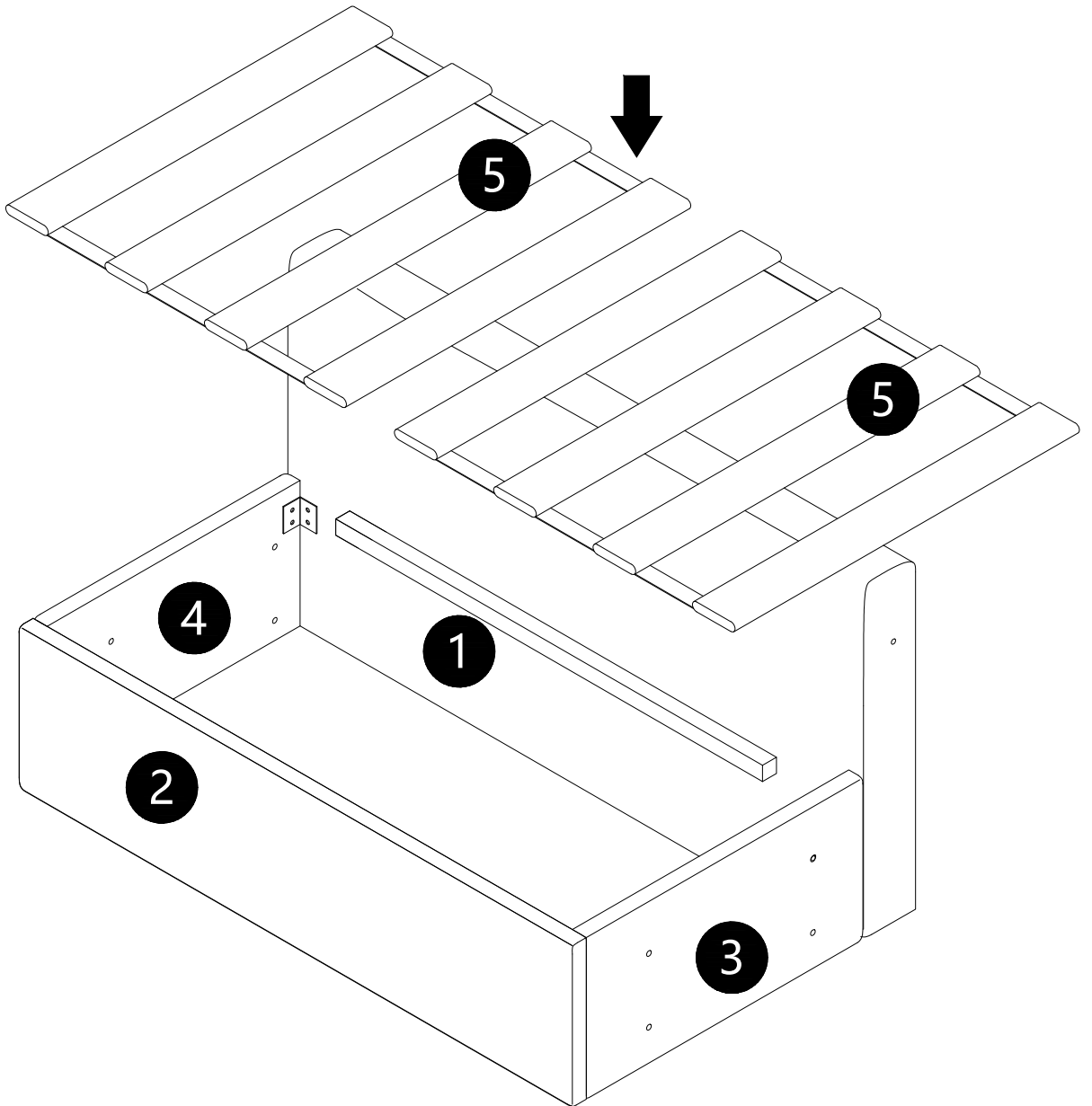

5

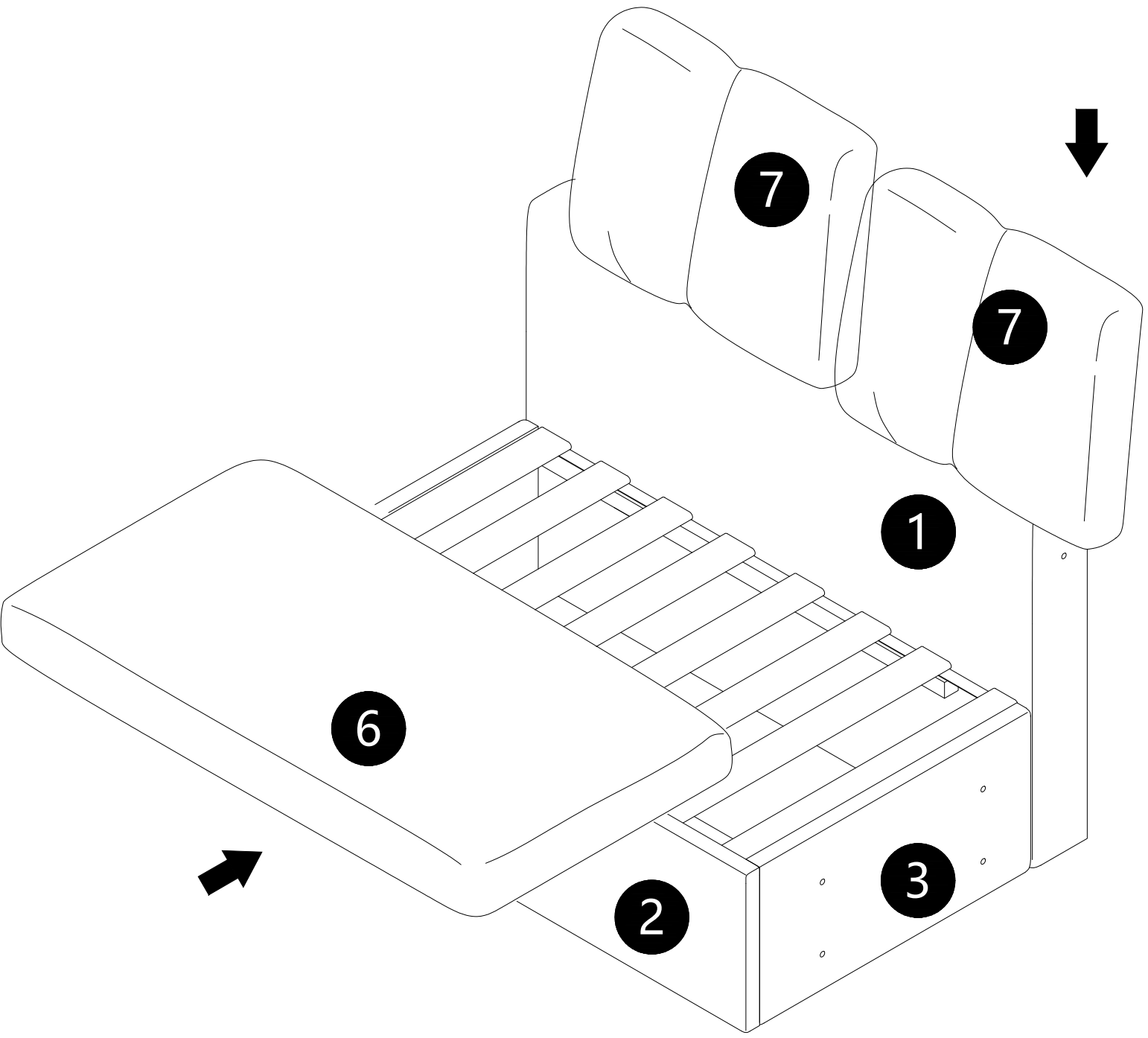
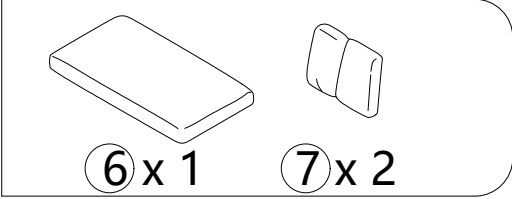

6



8x1

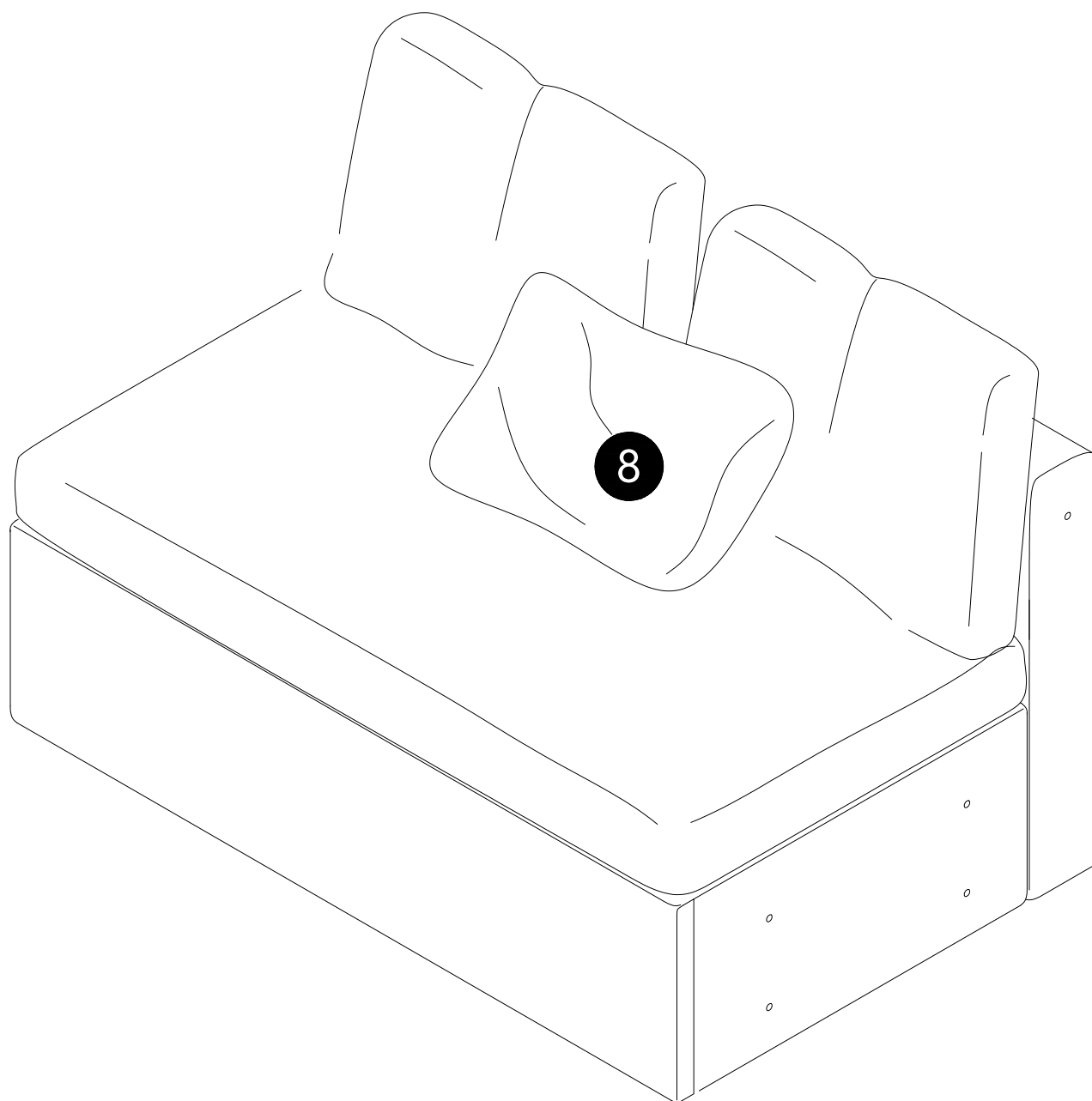

7

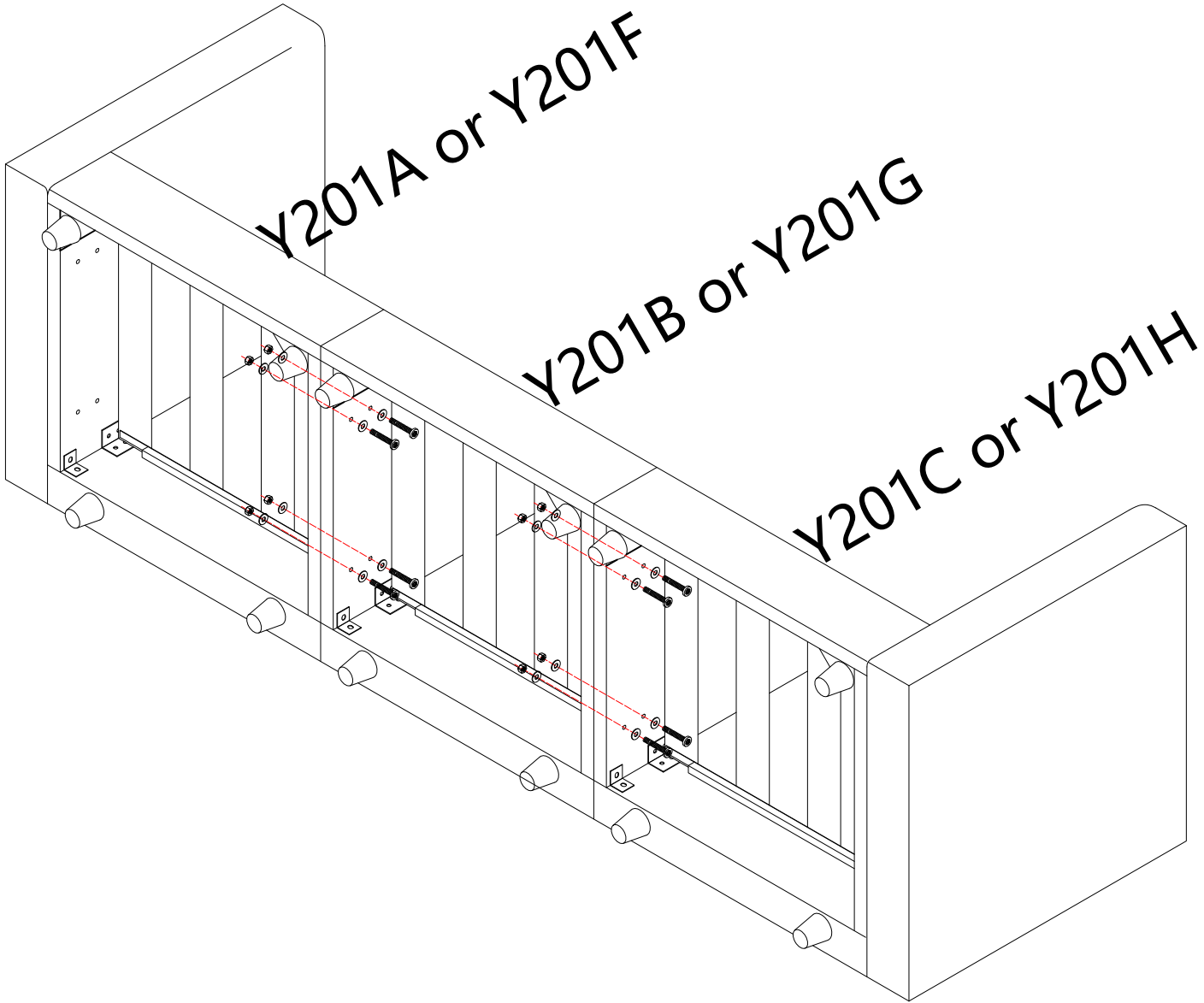

8

