

Assembly Instruction

11pcs High back cube dining set

How to ... assemble the table

You should have...











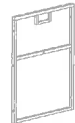
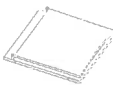









<p>Step 1</p> <p>J x 6 N x 2 P x 1 U x 16 R x 16</p>		<p>Step 2</p> <p>H x 2 I x 1 S x 8 U x 16 T x 8</p>		
<p>Step 3</p> <p>O x 12 U x 48 R x 48</p>		<p>Step 4</p> <p>L x 2 M x 1</p>		
<p>H x 2</p>	<p>I x 1</p>	<p>J x 4</p> <p>Longer length</p>	<p>K x 2</p> <p>Shorter length</p>	
<p>L x 2</p>	<p>M x 1</p>	<p>N x 2</p>	<p>O x 12</p>	<p>P x 1</p>
<p>R x 64</p> <p>M6*15</p>	<p>S x 8</p> <p>M6*45</p>	<p>T x 8</p> <p>M6</p>	<p>U x 88</p> <p>M6</p>	

Assembly Instruction

11pcs High back cube dining set

Accessories

You should have...

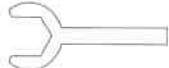
A x 6 	B x 6 	C x 6 	D x 6 
E x 4 	F x 8 	G x 4 	H x 2 
I x 1 	J x 6 		L x 2 
M x 1 	N x 2 	O x 12 	P x 1 
Q x 66  M6*35	R x 80  M6*15	S x 8  M6*45	T x 8  M6
U x 178  M6	V x 1  M6	w x 16  M6*30	Z 

Assembly Instruction

11pcs High back cube dining set

How to ... assemble the chair

You should have...

Step 1

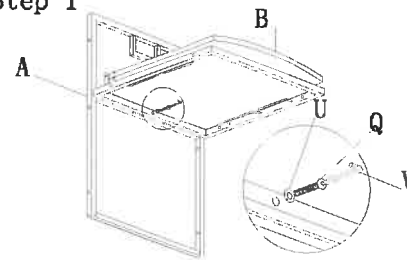

A x 1 B x 1 U x 1 Q x 1

Step 2

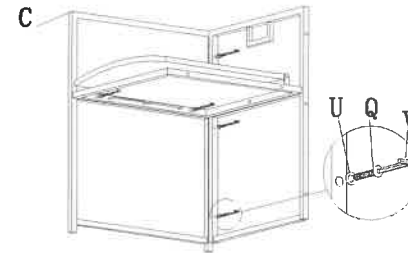

C x 1 U x 5 Q x 5

Step 3

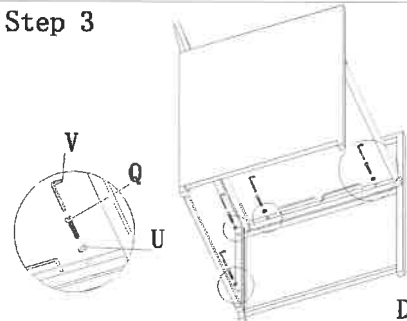

D x 1 U x 4 Q x 4

Step 4

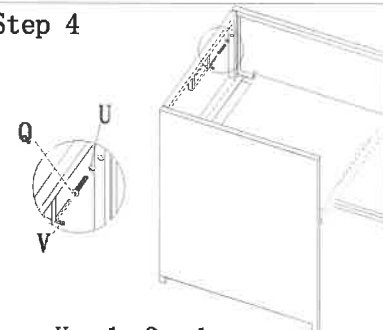

U x 1 Q x 1

A x 1



B x 1



C x 1



D x 1



Q x 11



M6*35

U x 11



M6

Assembly Instruction

11pcs High back cube dining set

How to ... assemble the foot stool

You should have...

Step 1

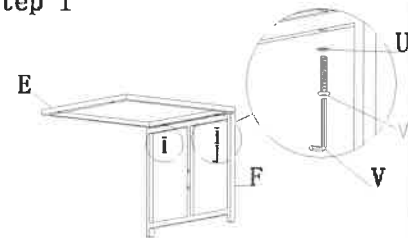

E x 1 F x 1 U x 2 W x 2

Step 2

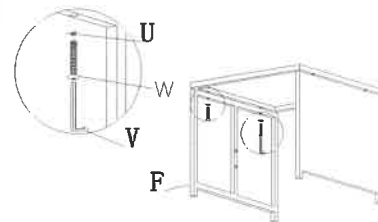

F x 1 U x 2 W x 2

Step 3

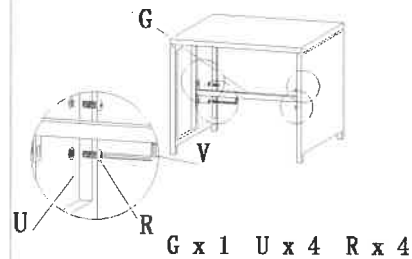

G x 1 U x 4 R x 4

Step 4

E x 1

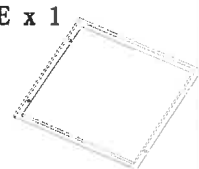

W x 4



F x 2



U x 8



G x 1



R x 4



Assembly Instruction

11pcs High back cube dining set

How to ... assemble the table

You should have...

<p>Step 1</p> <p>J x 6 N x 2 P x 1 U x 16 R x 16</p>		<p>Step 2</p> <p>H x 2 I x 1 S x 8 U x 16 T x 8</p>		
<p>Step 3</p> <p>O x 12 U x 48 R x 48</p>		<p>Step 4</p> <p>L x 2 M x 1</p>		
<p>H x 2</p>	<p>I x 1</p>	<p>J x 4</p> <p>Longer length</p>	<p>K x 2</p> <p>Shorter length</p>	
<p>L x 2</p>	<p>M x 1</p>	<p>N x 2</p>	<p>O x 12</p>	<p>P x 1</p>
<p>R x 64</p> <p>M6*15</p>	<p>S x 8</p> <p>M6*45</p>	<p>T x 8</p> <p>M6</p>	<p>U x 88</p> <p>M6</p>	