

ASSEMBLY INSTRUCTION

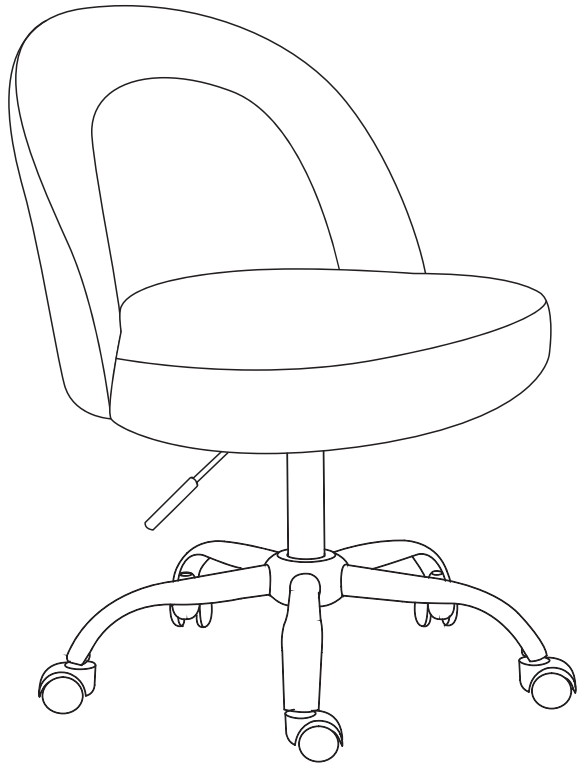

Disclaimer

To Valued Customers:

Thank you for purchasing furniture products from our store. To ensure your safety and the best user experience, please read and understand all the contents of this notice carefully before installation and use. Once you start installing or using this product, it is deemed that you have accepted all the following terms.

I. Regarding Installation

●**Professional Installation Recommendation:** For large, modular, or wall-mounted furniture, we strongly recommend that you hire qualified professionals for installation. Self-installation may involve risks.

●**Self-Installation Liability:** If you choose to install the product yourself, it means that you confirm you have the corresponding installation capability and voluntarily assume all risks and responsibilities arising from improper installation, including personal injury and property damage. Improper installation includes, but is not limited to, damage to product components due to ignoring installation instructions during the installation process, loose, missing, or wrong installation of connectors, and obvious instability such as tilting and shaking due to improper placement after installation.

●**Follow Official Instructions:** Installation must strictly follow the steps in the Installation Manual and diagrams provided with the product. Do not rely on any installation guidance from unofficial channels. Our company shall not be responsible for any problems caused by failure to follow official instructions.

●**Safe Installation Environment:** Please carry out the installation in a spacious, bright, and well-ventilated environment and use appropriate tools. During installation, please keep children and pets away from the work area to prevent accidental ingestion of small parts or accidental injuries.

II. Regarding Usage

●**Weight Capacity Limit:** Please strictly comply with the maximum weight capacity limit indicated on the product. Overloading may cause structural damage, deformation, or overturning of the furniture, leading to serious accidents. Our company shall not be responsible for any consequences arising therefrom.

●**Wall Mounting (Mandatory Requirement):** To prevent furniture overturning accidents, especially when there are children at home, you must use the anti-tip devices provided in the product package to permanently connect and fix the furniture to a solid wall. If the fixing devices are damaged or substandard, please contact us immediately through the purchasing platform to obtain replacement parts.

●**Special Warning:** The fixing method must fully comply with the requirements in the manual. Failure to fix as required may cause the furniture to overturn, resulting in serious injury or death. Our company shall not be responsible for any furniture overturning and all consequences caused by failure to perform wall mounting or improper fixing.

●**Regular Inspection and Maintenance:** It is recommended that you regularly (especially in the early stage of installation and after moving) inspect and tighten all connectors (screws, bolts, etc.) to ensure the structural stability of the furniture (see the maintenance method in the manual for details). Problems caused by neglect of inspection and maintenance are not covered by the warranty.

●**Proper Use and Placement:**

Place the furniture on a flat and solid floor.

Do not use the furniture for purposes other than its designed use (for example, standing on drawers or shelves, using a chair as a ladder, etc.).

Do not place heavy objects such as televisions or items that attract children on the upper part of the furniture.

Avoid placing the furniture in humid, sun-exposed, or extreme temperature environments to avoid affecting the product's service life or structural stability.

III. Liability Limitation

Our company provides warranty services for product quality in compliance with platform policies and relevant regulations. However, our company shall not be legally responsible for any direct or indirect personal injury, property damage, and other incidental losses caused by the following reasons:

●Failure to comply with the requirements of this notice, the official Installation Manual, or product labels;

●Misuse, abuse, negligence, or unauthorized repair or modification without our company's authorization;

●Improper installation (whether carried out by the user or a third party not designated by our company);

●Force majeure events.

Safety first, prevention is better than cure. We wish you a pleasant use!

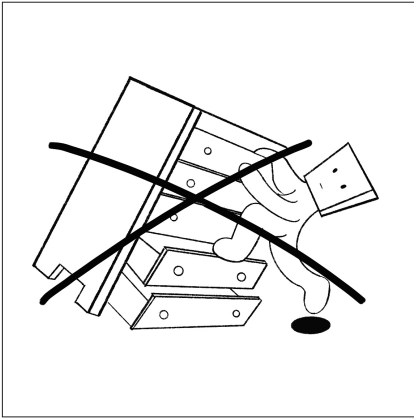

DO NOT CLIMB OR HANG

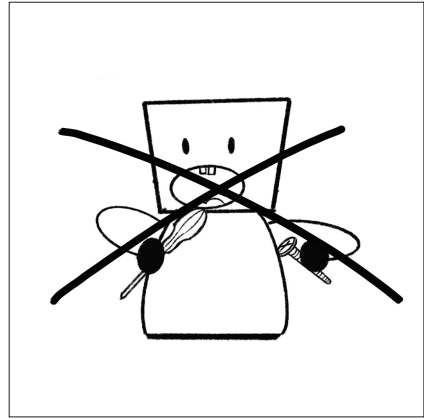

DO NOT PLAY WITH OR SWALLOW SMALL PARTS



(1) DO NOT stand or jump on the chair.

(2) Children should use this product with adult supervision.

Weight Capacity:

–Do not place items exceeding the maximum weight capacity of the product. (For the product's weight capacity, please refer to the product link.)

Usage Scenarios and Maintenance Methods

- Do not place the product in a humid environment.
- Avoid direct exposure to high temperatures and keep it away from heat sources.
- Clean and maintain the product regularly.
- Place it on a flat surface. When moving is required, ensure that at least two people lift it together.
- Check the condition of screws regularly. If any screws are loose or fall off, reinforce them promptly.

Chair products

Preparation before Installation

–Please read the assembly instructions carefully before installation and keep this manual for future reference. Check that all components are complete, including panels, hardware fittings, screws, plastic parts and other small components.

Ensure that **only adults** perform the installation, and keep children away from the installation area.

Instructions for Use

(1) Avoid prolonged exposure to direct sunlight or humid environments to prevent fading, aging, or mildew.

(2) **Even force application:** Avoid prolonged heavy pressure on a single point during use to extend the service life.



Notes

- **Do not** come into contact with corrosive substances and liquids to prevent discoloration or damage.
- **Do not** scratch it with sharp objects to avoid damaging the fabric and components.
- **Do not** stand on the product to prevent falls due to product sliding.
- **Do not** push it backward and downward violently, which may cause backward tipping and injury.
- **Do not** place it outdoors for use.
- When children use the product, it must be operated under adult supervision.
- **Do not** place items exceeding the weight – bearing capacity on the chair, which may cause the lifting function to fail.



Maintenance Methods

(1) **Do not** scratch it with sharp objects to prevent damage to the mesh fabric and components.

(2) Before cleaning the product, first suck up the dust on the product surface and in the gaps, and then clean with clean water and a clean cloth (a small – scale test is required first to ensure no fading, staining or damage will be caused).

(3) The hardware accessories of the product should be regularly inspected for looseness every month. If there is looseness/falling off, they should be fixed immediately.

(4) Keep away from fire sources and do not contact with acidic, alkaline chemicals and greasy substances.

(5) Avoid placing it near windows to prevent long – term dampness and direct sunlight.

(6) Regularly remove entangled hairs and fibers from the casters and the gas lift cylinder.

Please check all parts and accessories according to the parts list before assembling, make sure all contents are sufficient and in good condition. If there is any parts missing or defective, please contact us immediately with purchase platform message to get replacement parts.

PARTS:

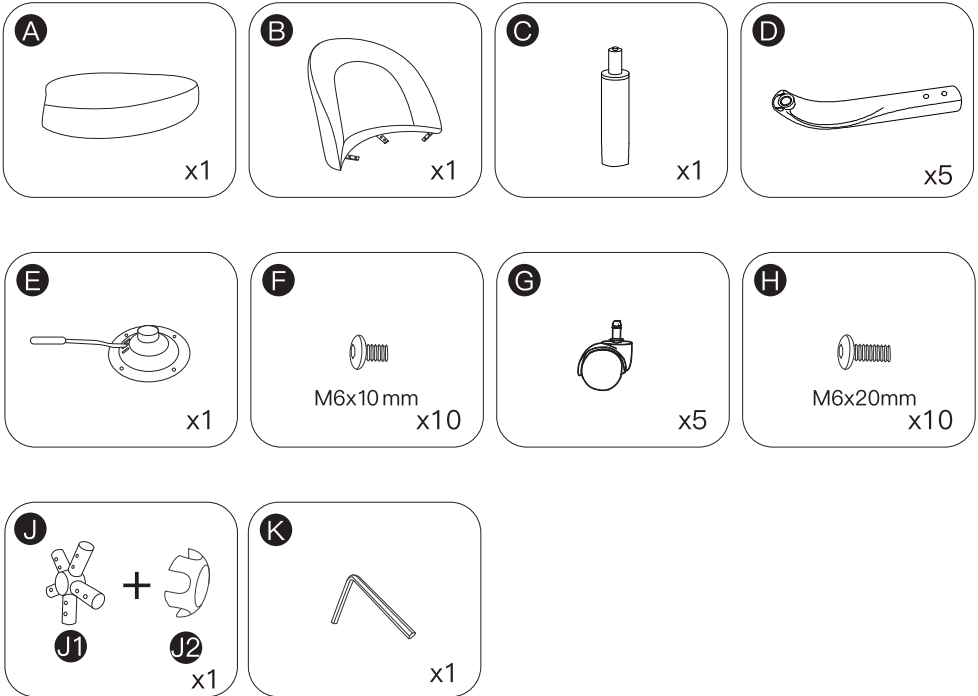



Attention:

For your safety, we recommend two or more people to install it together.

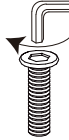

Attention:

To make the chair more stable, please tighten all screws with a hex screwdriver.



Attention:

To make the chair more stable, we recommend checking the tightness of the screws every month. If there is any looseness, please tighten them again immediately.



Check the tightness of screws regularly (once a month).



Prevent accidents

Gas Spring Fault Warning

If the gas spring malfunctions (such as leakage, component damage, reaching the end of its service life, or failure to lift/lower normally), please stop using it immediately.



Safety Notice

Prohibition of reaching forward or downward for items when both feet are off the ground



HOW TO INSTALL

STEP 1

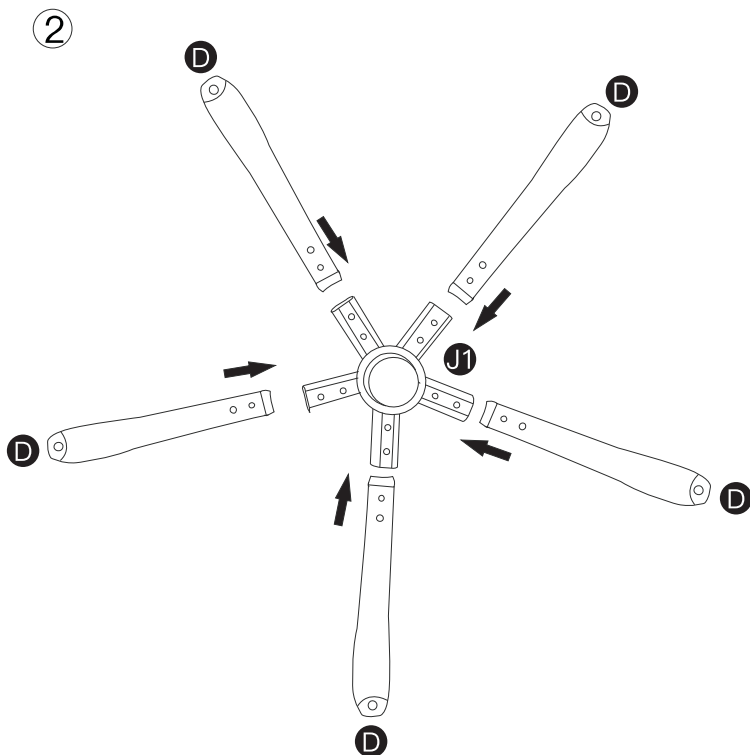
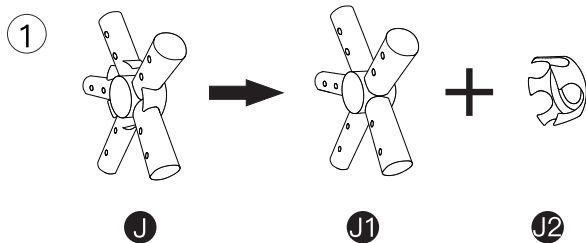
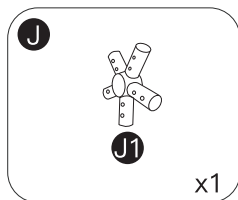
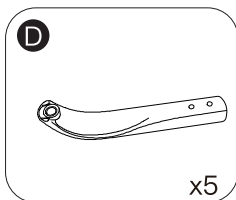

STEP 2

F



M6x10mm
x10

NOTICE:

Please ensure all screws are aligned with the holes before tightening them.

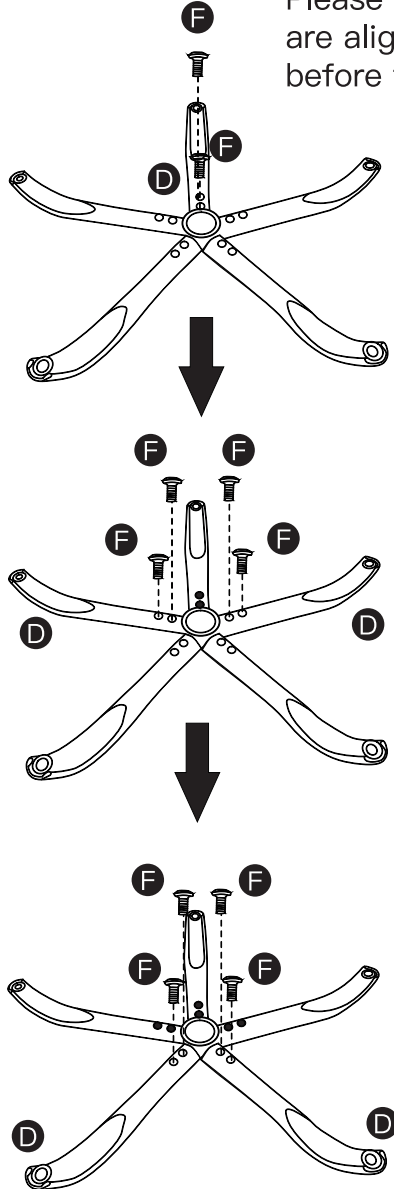

STEP 3

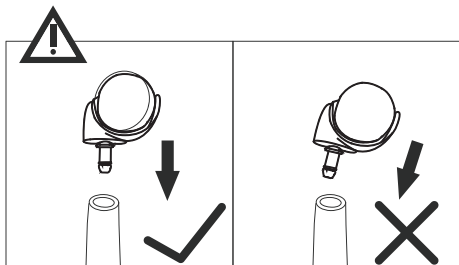
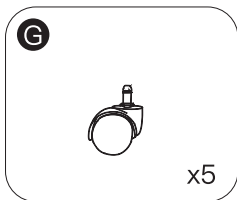

NOTICE:
Push the wheel **firmly** in to ensure it is securely fastened.

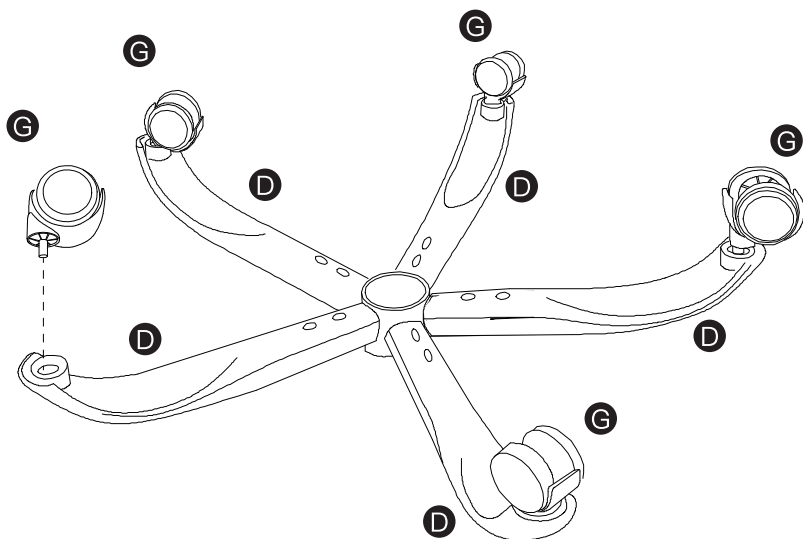

STEP 4

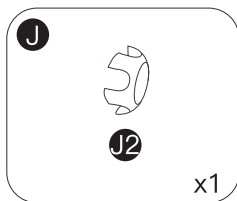
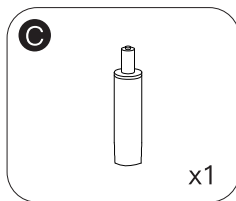

NOTICE:

Please flip the finished product installed in the third step 180°.

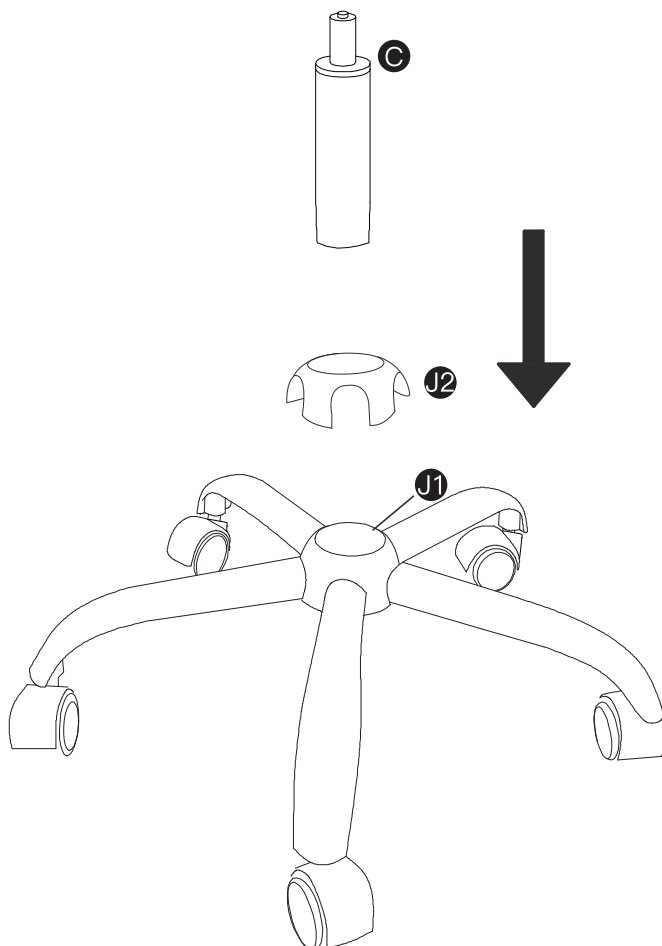

STEP 5

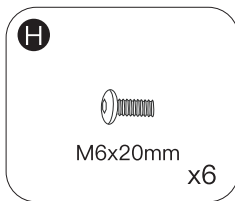
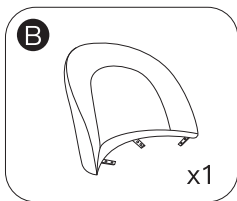
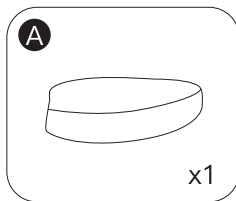

NOTICE:

For getting a more sturdy product, please press both part **A** & **B** towards the center at once, ensuring that the holes are aligned, then tighten the screws.

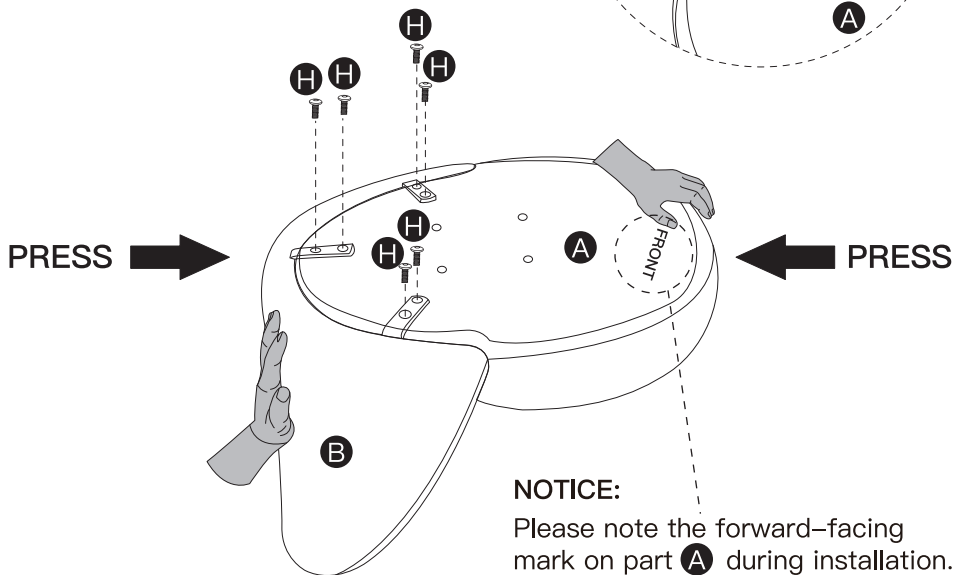
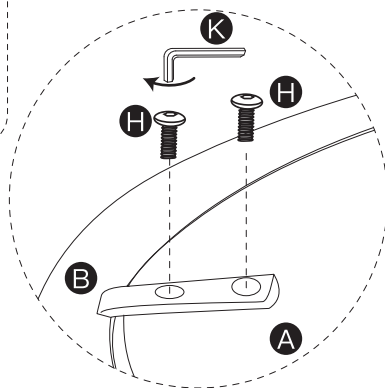

NOTICE:

Please note the forward-facing mark on part **A** during installation.

STEP 6

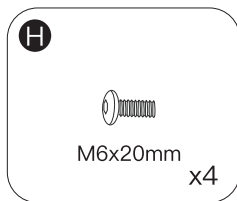
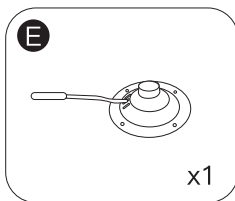

NOTICE:

Please note the orientation of the arrow mark on Part **E**.

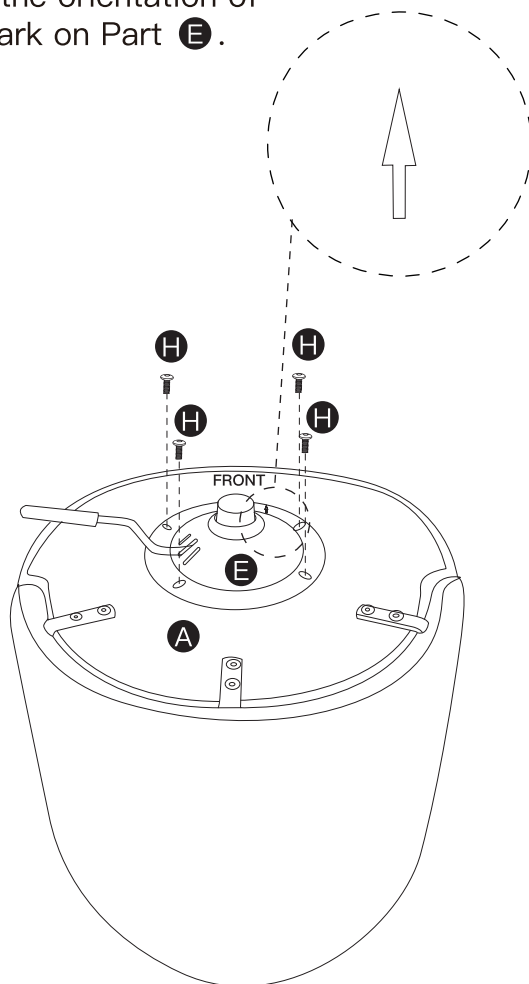

STEP 7

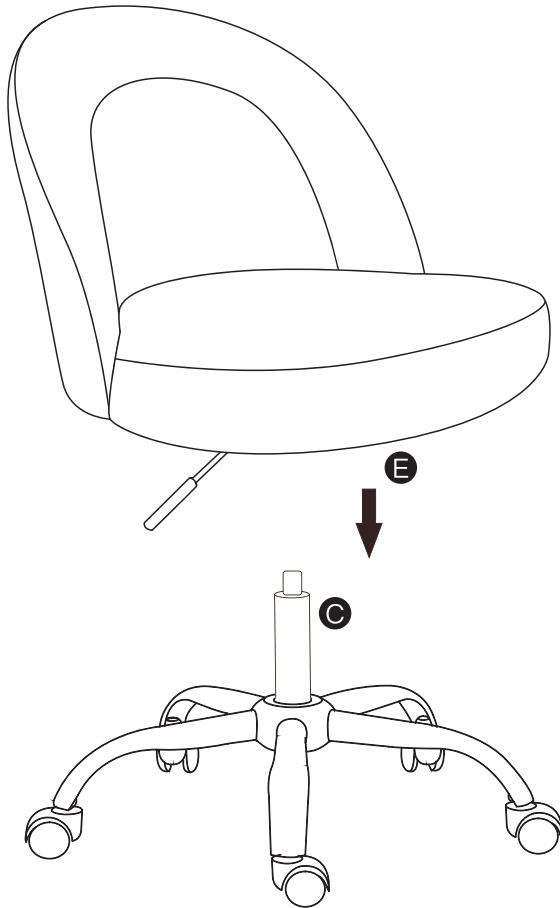

STEP 8

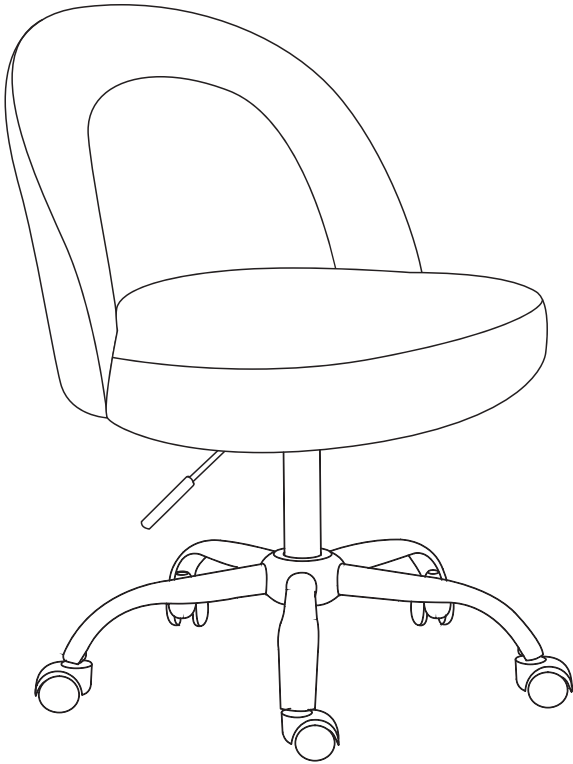

How to Use All Functions of the Chair

Adjustable height lever

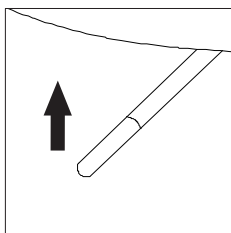
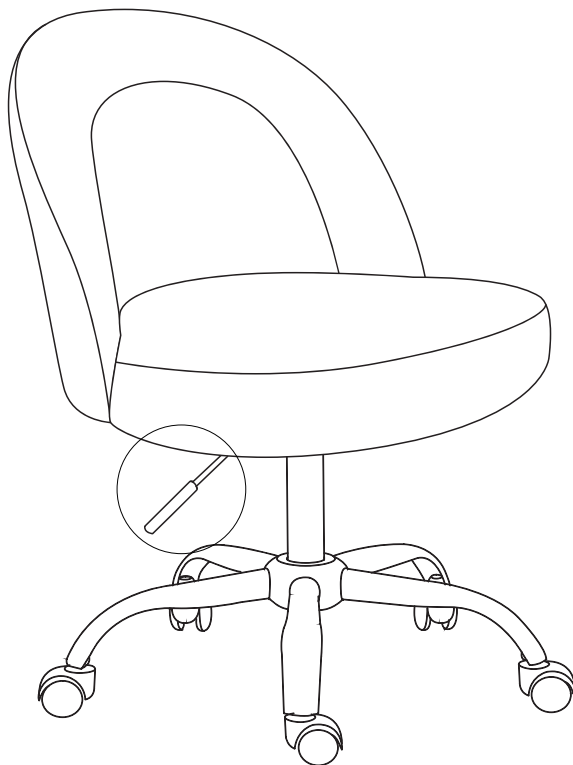

(1) There is an adjusting rod at the bottom of the cushion; pushing it upward allows you to freely adjust the height of the chair.

(2) When raising the chair, do not sit on it while operating the lever; when lowering the chair, you need to sit on it, pull the lever upward, and then sit down firmly.

Wheel Category

Instructions for Use

–Deodorization: It is normal for wheels to have a rubber smell, so there is no need to be nervous. Just place the wheels in a well-ventilated area to let the smell dissipate before installation.

–Usage Method: Install them at the bottom of compatible products, ensuring that the wheels can rotate flexibly, the braking function (if any) works properly, and push at a constant and stable speed. Avoid driving quickly on uneven ground to reduce wheel wear.



Notes

- Ensure the integrity of accessories: Prevent collisions and falls that may cause wheel deformation and bearing damage, as well as hard objects from scratching the wheel surface.
- **Load-bearing limit:** Strictly use within the rated load to avoid wheel damage and product tilting due to overloading.
- **Ground protection:** Avoid long-term use on sharp, uneven ground to prevent wheel surface wear and jamming.
- **Brake usage:** For wheels with a braking function, please brake and fix them in time when the product is not in use to prevent the product from sliding.
- For the safety of you and your family, it is recommended to install the **Anti-Tip Device Kit**.



Maintenance Methods

Cleaning method: Wipe the dust and debris on the wheel surface with a damp cloth, and clean the bearing parts with a dry soft brush. Regularly check the wear of the wheels, whether the bearings rotate smoothly, and whether the brakes are sensitive, and replace severely worn wheels in time.

Gas spring

Installation and Initial Adjustment

Confirm compatibility: The diameter of the gas spring must fully match the hole position of the seat base and the sleeve of the five – star base. Otherwise, it will cause wobbling or falling off.

Insertion specification: Press vertically into the sleeve of the five – star base. After hearing a "click" sound, press down on the seat forcefully to ensure locking (**Hammering is prohibited!**).

Height adjustment: After sitting steadily, pull the lifting rod and adjust to a height where the thighs are parallel to the ground and the feet are placed flat (**Avoid leg numbness caused by hanging in the air**).



Notes

- **Daily Lifting Operations**
For correct operation: after sitting firmly, press the control lever once. Adjust the elevation in stages (2–3 seconds each time) and release the lever once it reaches the top.
- **Dangerous operations:** Forcibly pressing down while standing, holding the control lever continuously, and continuing to pull up the seat with force after it reaches the top.
- **Consequence description:** The gas strut rebounds instantly, causing an impact. The internal oil temperature rises sharply, accelerating the aging of the sealing ring, which leads to the separation of the gas strut from the base plate.
- **Load-bearing and posture specifications:** Overloading may cause seal burst or slow settlement. Never cross your legs to apply pressure on one side, kneel on the seat, or stand and shake—these behaviors will lead to uneven wear and air leakage of the gas strut.



Maintenance Methods:

(1) Monthly Inspection:

Oil Leak Detection: Wipe the metal cylinder of the gas strut with a white tissue. If transparent or light yellow oil stains appear, stop using it immediately and replace it.

Looseness Test: Hold the seat with both hands and shake it left and right to check if there is abnormal noise or displacement at the connection between the gas strut and the base plate/star base.

(2) Cleaning and Protection:

For the metal cylinder: Wipe off surface dust with a dry cloth. Never use penetrating lubricants (**they will corrode the sealing ring**).

Rust Prevention: In coastal or humid areas, apply car wax to the metal cylinder once a month (**avoiding the telescopic gaps**).

(3) Lifespan Management:

If the height cannot be locked, the seat drops slowly automatically, or there is jamming/abnormal noise during lifting, the entire unit must be replaced (**non-repairable!**).

AFTERSALE SERVICE

Dear customer,

We are pleased that you have chosen our product as part of your home. We care deeply about your experience and hope that you receive all the help you need.

We sincerely hope this product meets your expectations and hope that you will consider us again in your future needs.

The packaging may exceed our control during transportation. If there are any issues with the box or contents, please contact us directly. We will provide you with high-quality after-sales service. Please kindly wait for the response from our team.

Thank you once again for choosing us. Let's create wonderful memories and comfortable spaces together!

Kind regards,
Customer Care Team