

USER'S MANUAL

ACCENT CHAIR

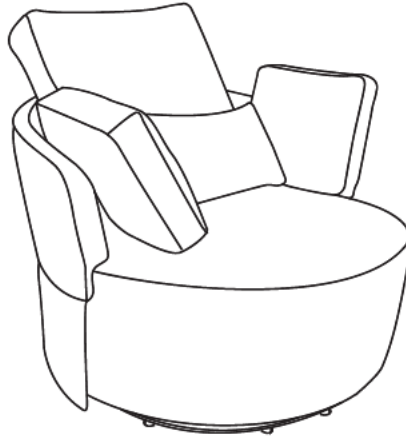

Guide of Manual

- ★ Thanks for your choice. **We will do our best to provide customer service for everyone.**
- ★ Please check to make sure all parts are included as stated when you unpack. **If there are parts missing or wrong, please contact us, we will expeditiously provide reissue accessories, compensation or other services.**
- ★ Instruction should be read carefully. But the manual may not cover every detail of all possible situations and steps. **Please contact us if further information and help are needed. We will respond in a timely manner.**
- ★ **Please be patient that the other items are on the way if you buy more than one product.**

Warning

- It's kindly advised to assemble this product on a carpeted floor to protect it from being scratched.
- Small parts are included. Please keep the product away from children while assembling. Do not let children play or jump on the product. Do not stand on the item or use as a step ladder.
- Please pay attention to the sharp corners during assembly. We recommend the use of gloves to prevent the undesired injury.
- Prior to use, please check to see if there's any loosening screw or part. Make sure that each screw and part is correctly installed and securely fastened.
- Usually it's unnecessary to use electric drill. Please at a low gear if you need.

Care and Maintenance

- Use a soft, clean cloth that will not scratch the surface when dusting.
- There's no need to use furniture polish. If you need, test it first in an inconspicuous area. Using solvents of any kind on your furniture may damage the finish. Never use water to clean your furniture as it may cause damage to the finish.
- Liquid spills should be removed immediately. Gently blot the spill with a soft clean cloth to avoid rubbing.

Further Advice About The Furniture Care







- It is best to keep your furniture in a climate-controlled environment.
- We recommend to keep furniture from sunlight exposure to avoid possible surface damage.
- Following these important and helpful tips will help retain your furniture's performance even when it ages.
- Periodically (every 90 days) make sure the screws are fully tightened.

**⚠ MAX WEIGHT CAPACITY:350LBS
DO NOT STAND ON THE ITEM**

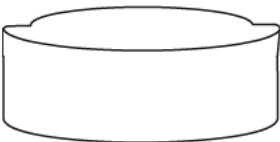



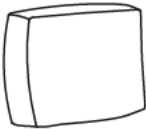

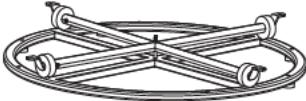

Parts List & Assembly Instruction

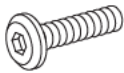
1. Make sure all parts are in the package.
2. "+" in below list indicates that additional pieces are replacement parts.
3. Do not fully tighten anything until all screws, nuts, washers and bolts are in place.

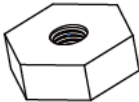
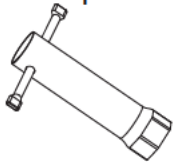
Parts List

<p>Ax1pc Seat Base</p> 	<p>Bx1pc Left Back</p> 	<p>Cx1pc Right Back</p> 	<p>Dx1pc Back Cushion</p> 
<p>Ex2pcs Accent Pillow</p> 	<p>Fx1pc Lumbar Cushion</p> 	<p>Gx1pc Swivel Base</p> 	

Hardware List

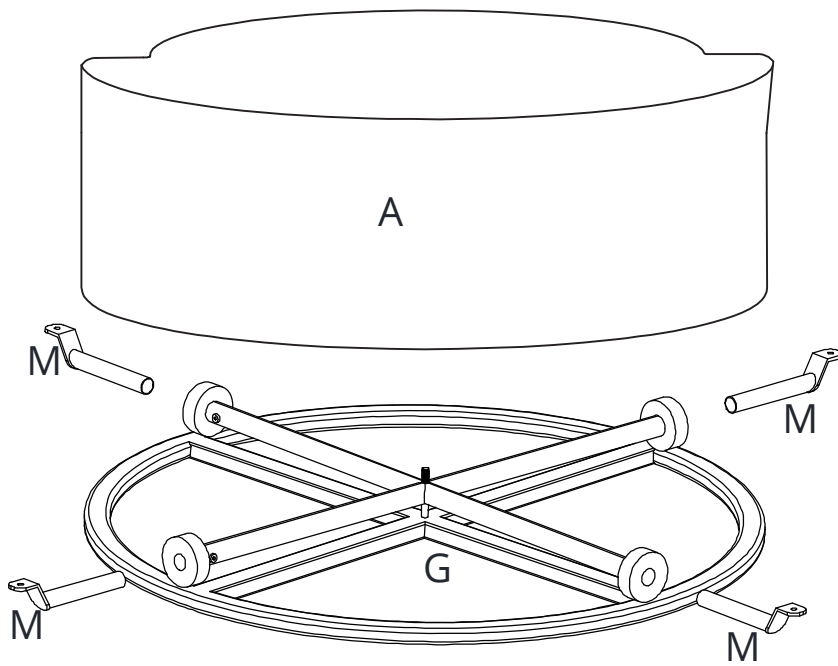
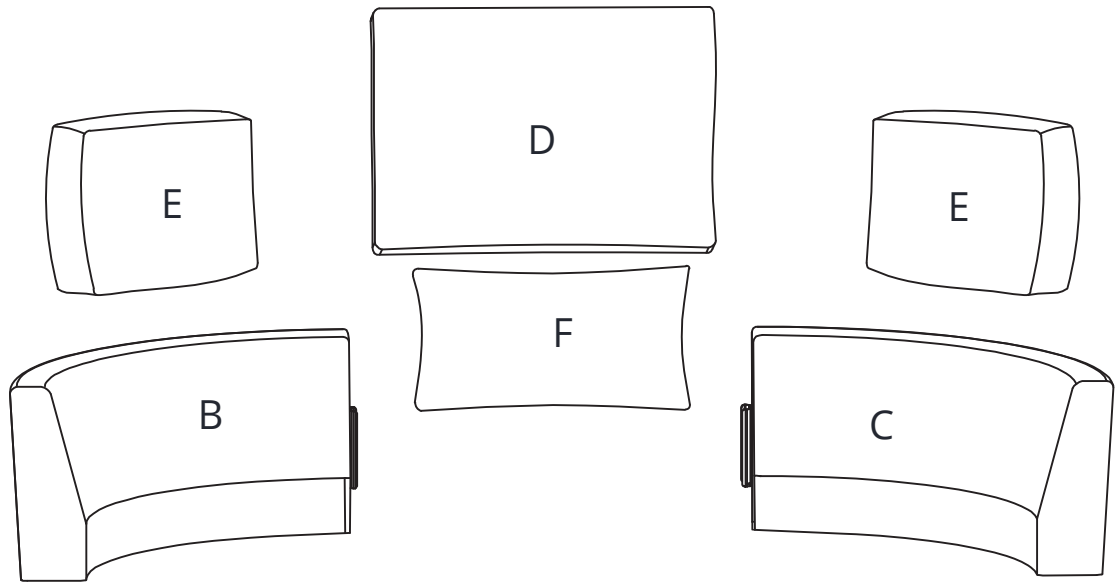

<p>Hx4+1pcs Screws</p>  <p>M6*30mm</p>	<p>Ix6+1pcs Fully Threaded Rods</p> 	<p>Jx6+1pcs Nut</p> 	<p>Kx1pc Box Spanner</p> 
<p>Lx1pc Allen Wrench</p>  <p>M6</p>	<p>Mx4pcs Iron Pipe</p> 	<p>Nx6+1pcs Flat Washers</p> 	<p>Ox6+1pcs Spring Lock Washers</p> 
<p>Px8+1pcs Leveling Feet</p> 			



Step 1

The end with the shorter thread should be screwed into the backrest B and backrest C in step 1 .

I  x6

80%
X 
100%
✓ 

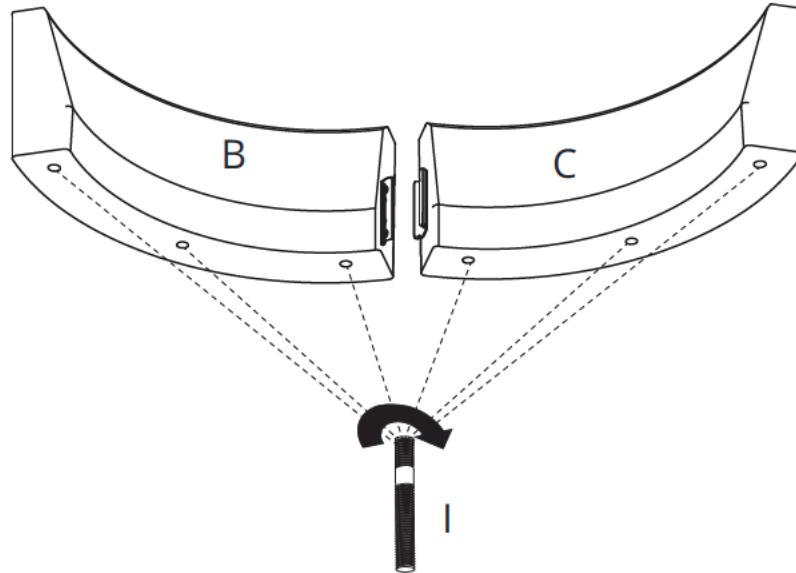



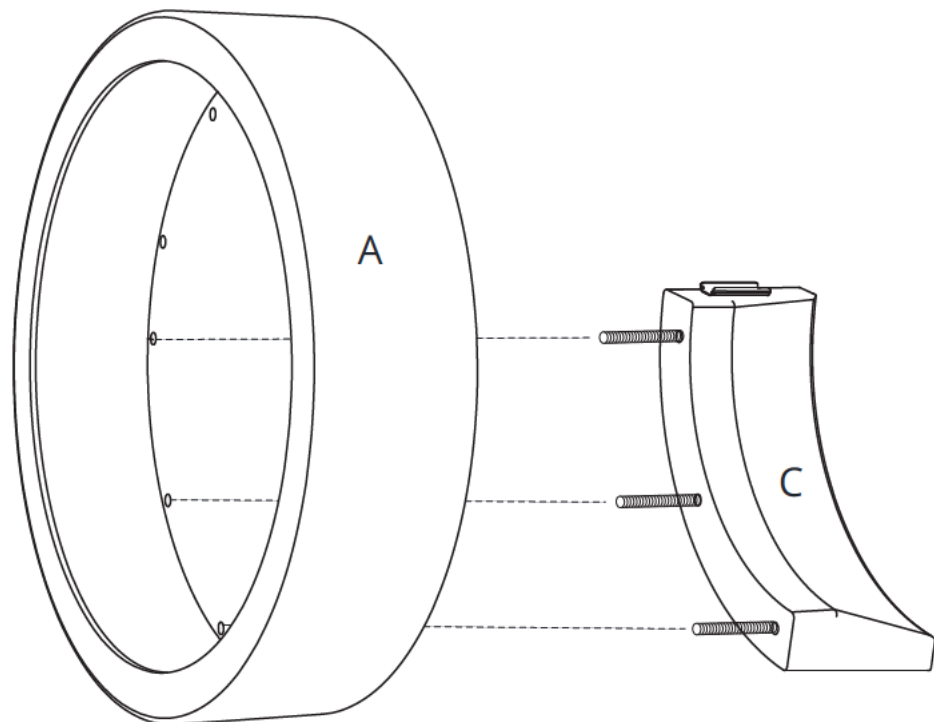

Step 2

Insert the backrest C into the base A.



Step3

Install the hardware J, O, N onto the fully-threaded rods of the backrest C and tighten it to 80% by tool K.

J		x3
N		x3
O		x3
K		x1

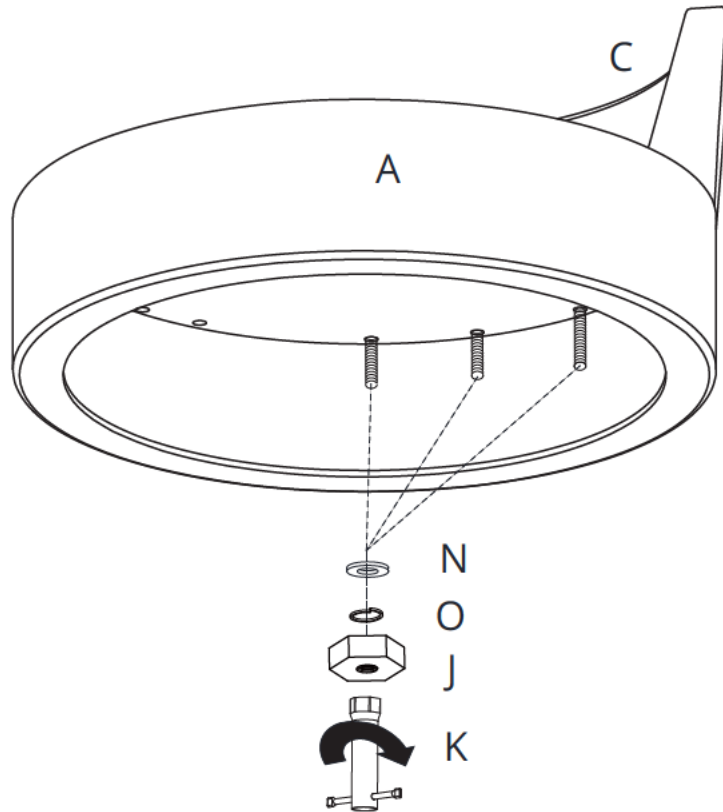
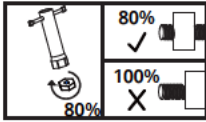



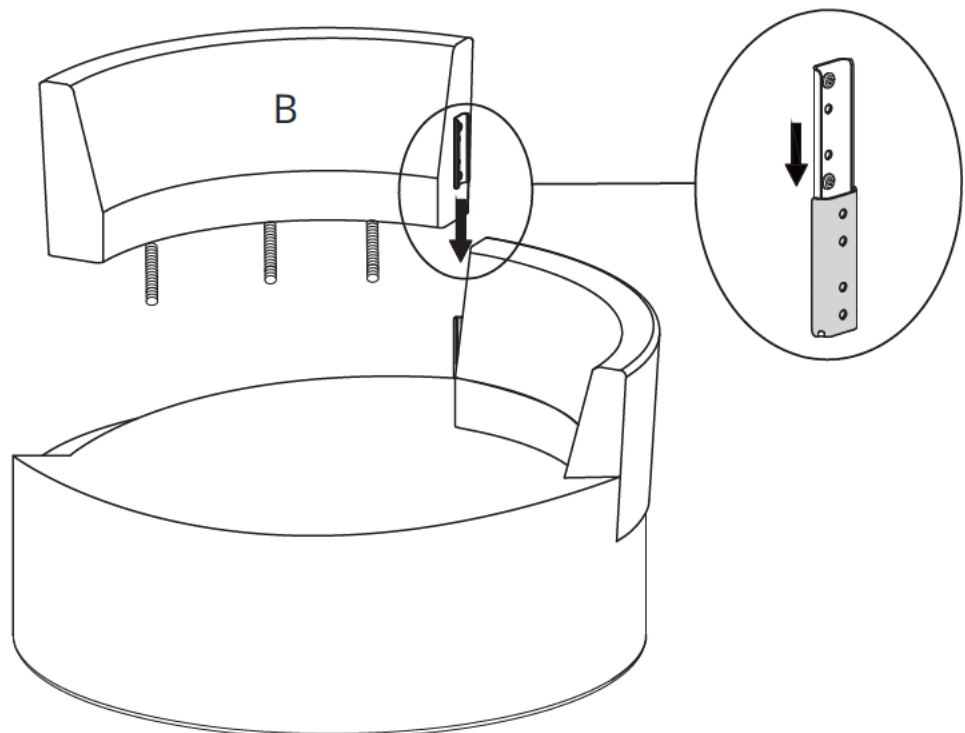

Step4

Attach the backrest B to C, ensuring that the insertion pieces on B and C are aligned when inserting from the top.



Step 5

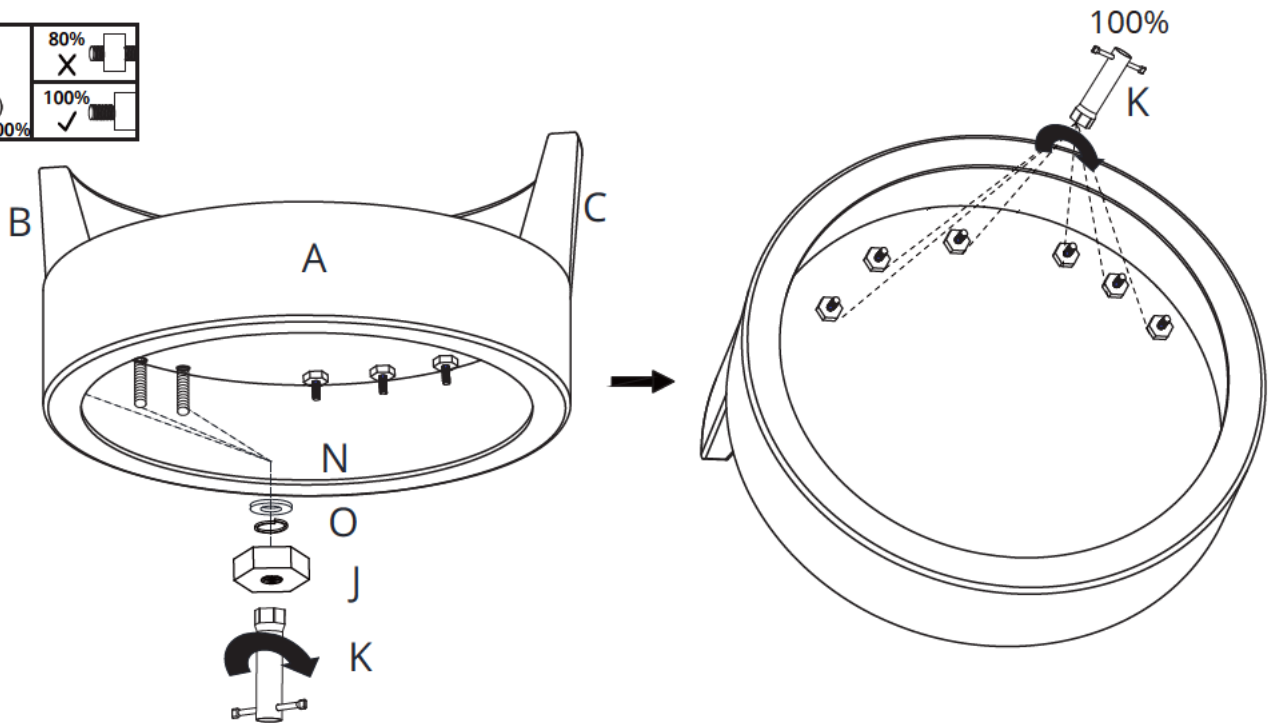
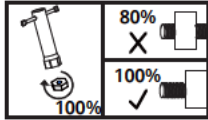

Install the nut onto the fully-threaded rods of the backrest B and tighten it to 80%, then tighten all nuts to 100%.

J		x3
N		x3
O		x3
K		x1



Step 6

Please first remove the screws from the swivel base G before place the iron pipe M into the swivel base G at the angle indicated in the diagram. And attach the leveling feet P to the swivel base G.

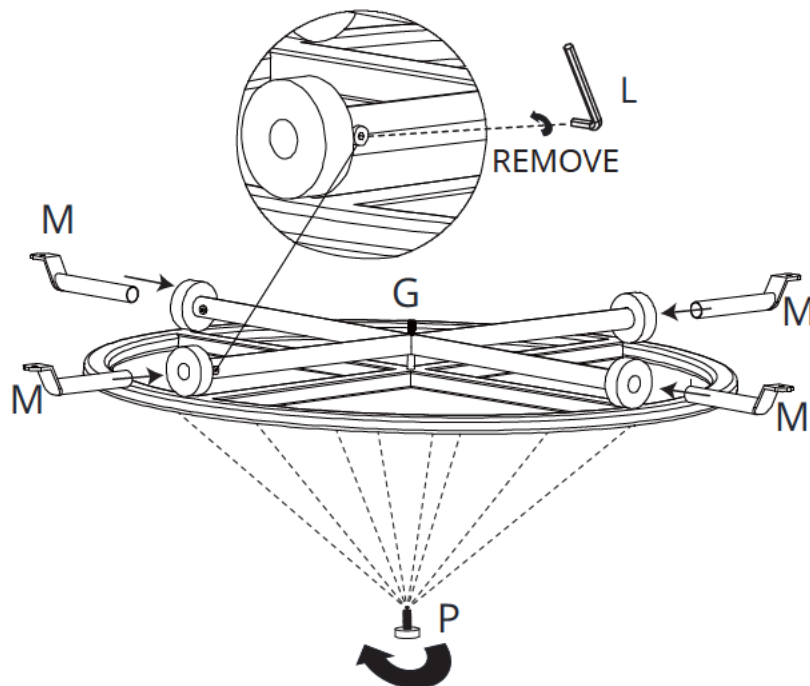
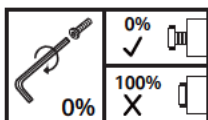

P		x8
M		x4



Step 7

Tighten the screws H to 80% in Step 7, then tighten all screws to 100%.

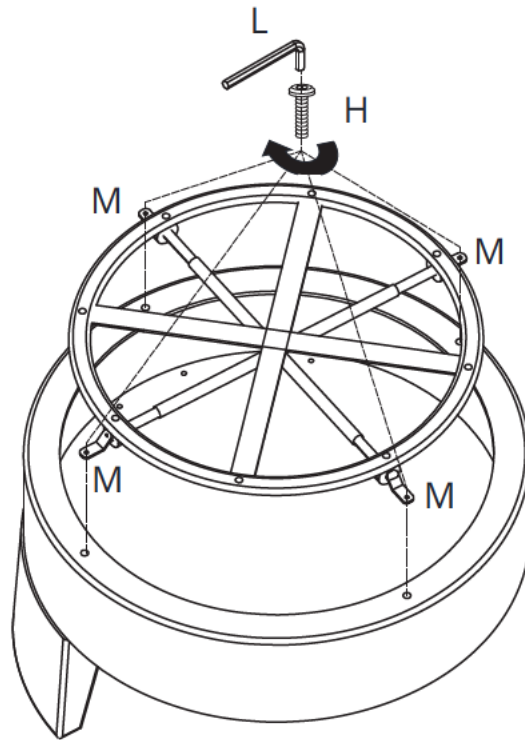

H		x4
L		x1

	80%	
	100%	



Step 8

After step 7, use the Allen Wrench L to tighten the small screws on the swivel base G that were removed in Step 6.

	80%	
	100%	

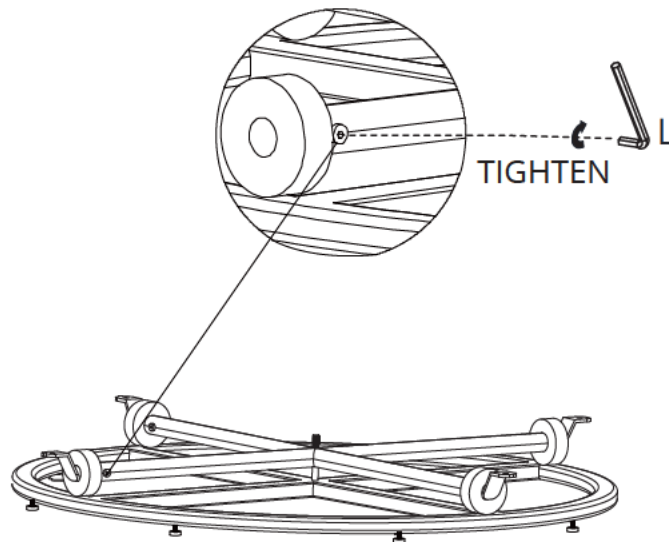

Step9

Place D, E and F onto the Seat Base.

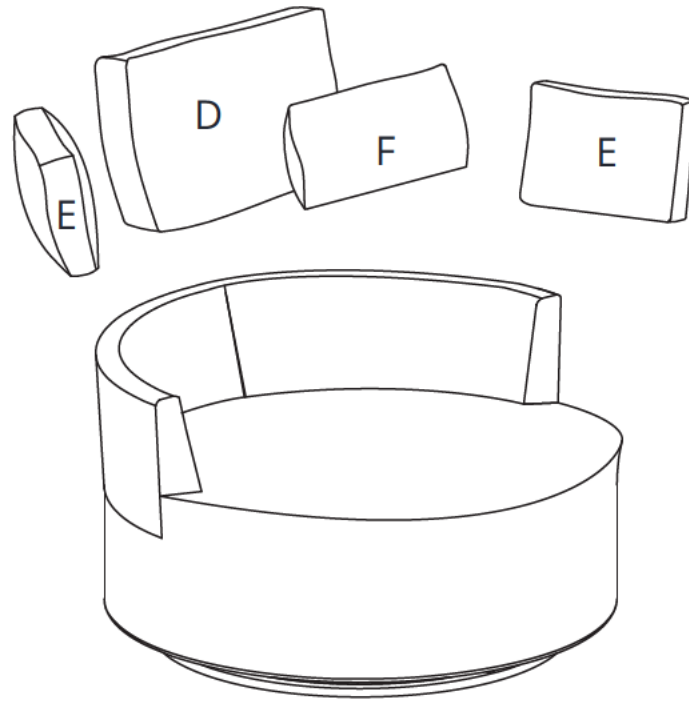

FINISHED

