

Life Gets Better With Us

USE AND CARE GUIDE



Table of Contents

Table of Contents	2	Pre-assembly	3
Safety Information	2	Assembly	4-5
Warranty	2	Care And Maintenance	6
What is Covered	2		
What is Not Covered	2		

Safety Information

- Tighten each bolt firmly and properly. Do not completely tighten screws until all screws are started.
- Some parts may contain sharp edges. Wear protective gloves as necessary.
- Children under the age of 16 should not be engaged in the assembly, removal or disassembly of the product. Children under the age of 10 should be supervised by a competent adult while using this furniture.
- Please keep children out of the assembly area during assembly.
- This set is heavy, and may require two adults for safe assembly.
- Never use this product as a support. Do not shake, lean, or climb on the product at any time.



DANGER : Do not allow children to play with plastic wraps or small parts to prevent potential choking hazard.



CAUTION: Read all the instructions before assembly. Failure to do so may result in faulty assembly and potential injury!

Warranty

LIMITED WARRANTY

This warranty is a limited warranty, and applies to the original purchase is required. This is a residential warranty and does not apply to commercial use. This collection carries a (1) year limited warranty and is valid from original date of purchase to the original owner (proof of purchase required).

WHAT IS COVERED

We warrant the frame to be free of Manufacturing defects to the original purchaser for one year.

WHAT IS NOT COVERED

This warranty does not cover commercial use, hardware, acts of nature, fire, freezing and abusive.

In addition, purchased parts are not covered under this warranty.

We reserve the right to make substitutions with similar merchandise, if the model in question is no longer in production.

For a copy of our full limited warranty, please contact our customer service team below.

Pre-assembly (continued)

Assemble the item on a soft, non-abrasive surface, such as carpet or cardboard to avoid damaging the item. Seek assistance to assemble bulky or heavy items.



NOTE: Identify all parts packed in the carton against the parts list.
Remove all the protective material carefully and DO NOT use a knife to prevent scratching the furniture.

PACKAGE CONTENTS

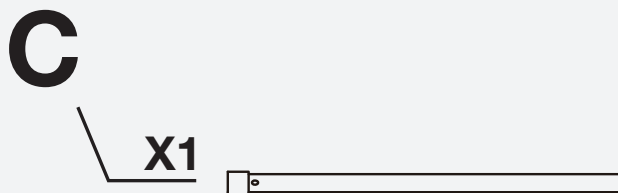
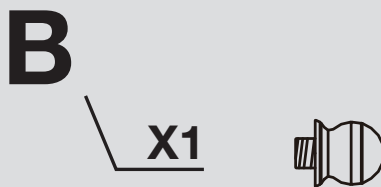
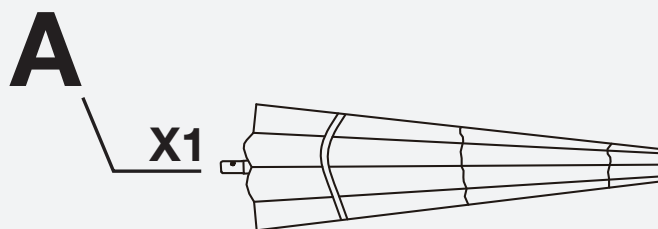

NOTE: Hardware not shown to actual size.

Assembly

1

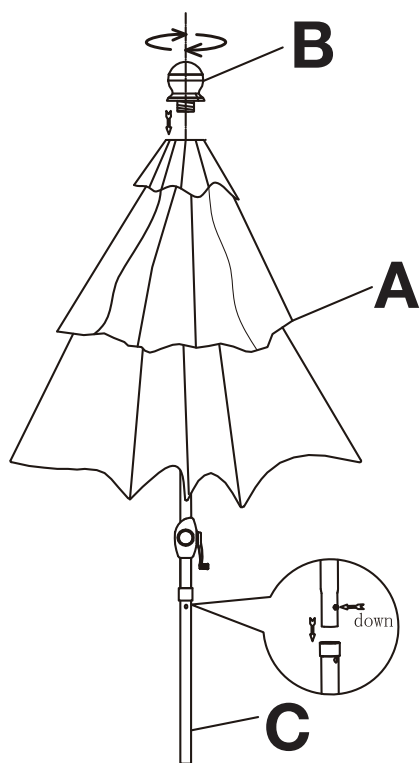

2

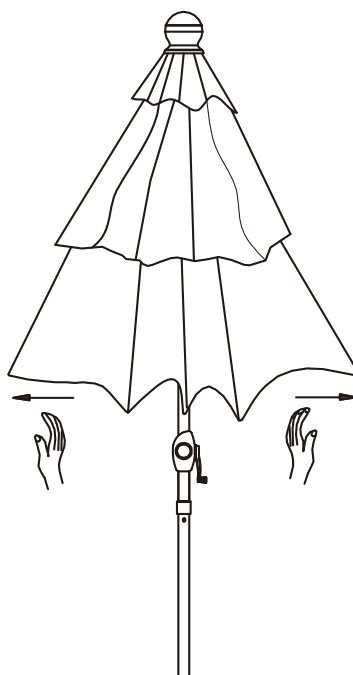

Assembly

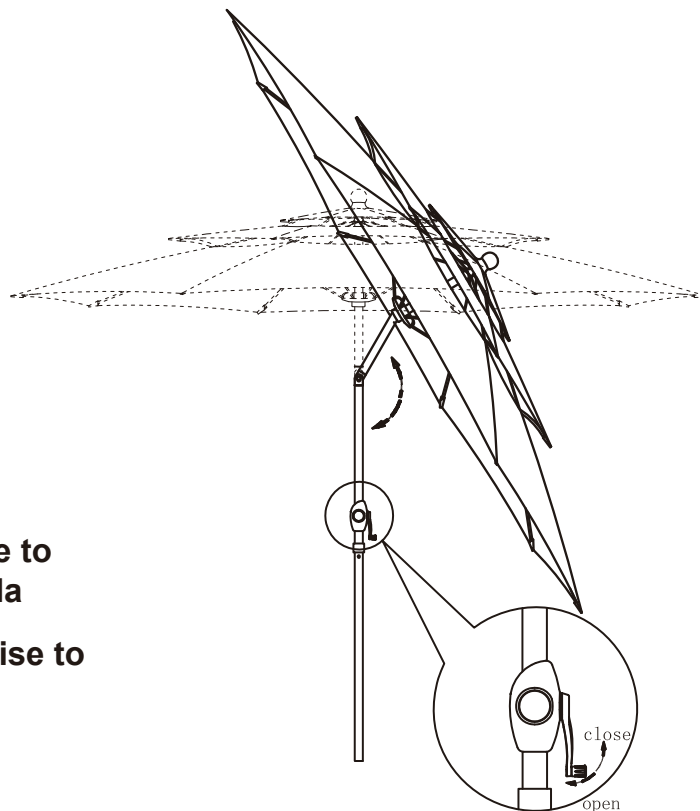
3

Attention!

1. Turn crank clockwise to fully open your umbrella
2. Keep turning clockwise to tilt the umbrella cover
- 3, To fold up, turn anti-clockwise

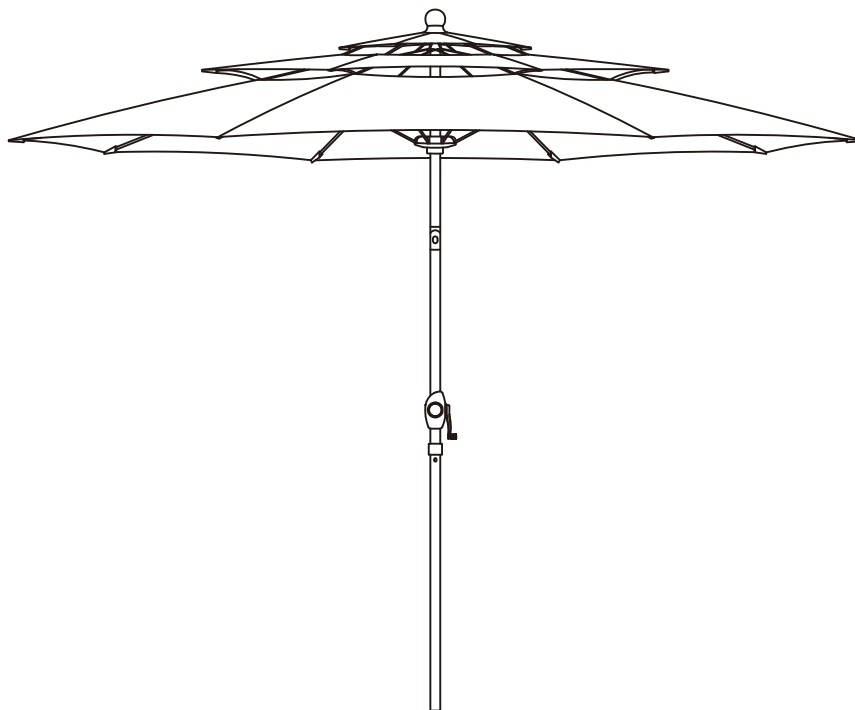
4

Cleaning and Maintenance

- To clean your canopy, use only mild liquid soap and water, and a soft sponge to loosen and dirt. Never use bleach or cleaning solvents as it will discolor your canopy. Use a mild soap and cloth to clean your aluminum or steel frame.
- When using an umbrella with a table, always make sure the protective ring is in the umbrella hole and the umbrella is secured using a sturdy umbrella base.
- We recommend that this product be closed and secured during high winds and heavy rain conditions.
- Powder coated steel is durable and will last for many years of seasonal use. It is recommended to touch up or repair any scratches to the paint surface to prevent rust.
- If you see rust, carefully sand the area using a fine sand paper and apply a rust resistant paint that closely matches the frame color.
- It is always recommended that an umbrella cover be used when not in use, as prolonged exposure to the sun's rays will eventually cause canopy fading or discoloring.