

INSTALLATION MANUAL

CEILING FAN WITH LIGHTS

Model No.: LL-1102B-24

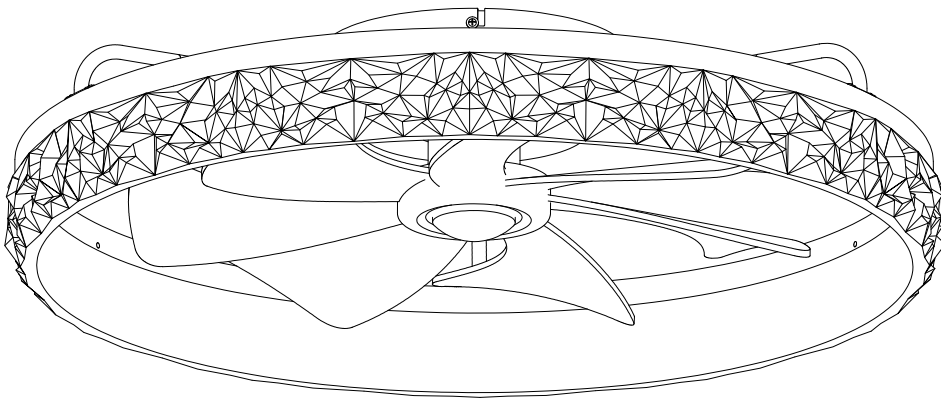

APP Control Applicable

TOOLS REQUIRED



Ladder



Pliers

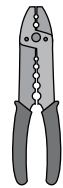

Wire
Strippers

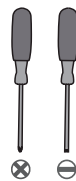





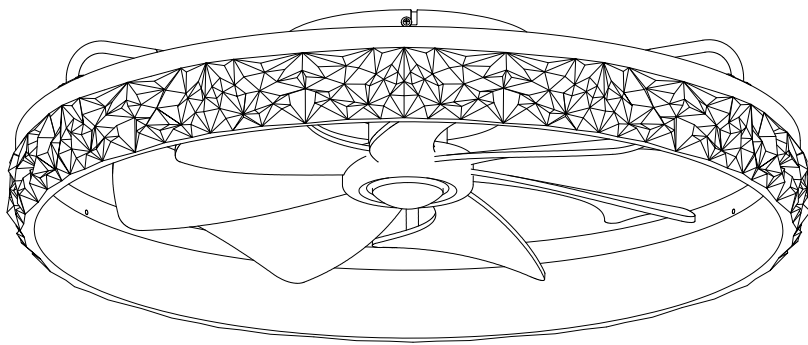







Screwdrivers

PACKING LIST

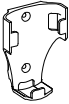

A Fan Assembly ×1

INSTALLATION KIT

AA	1×	BB	3×	CC	2×	DD	4×	EE	4×	FF	1×
											
Mounting Bracket		Wire Nut		Outlet Box Screw		Long Wood Screw		Long Plastic Anchor		"S" Hook	
GG	4×	HH	2×	II	2×	JJ	1×	KK	1×	LL	1×
											
Canopy Screw		Short Wood Screw		Short Plastic Anchor		Remote Control		Remote Holder		Pair of Gloves	

NOTE:

1. The listed quantity is for installation, extra hardware may be included.
2. Mounting bracket (AA) and canopy screws (GG) are pre-installed on fan assembly (A).

INSTALLATION

1. Install the Mounting Bracket

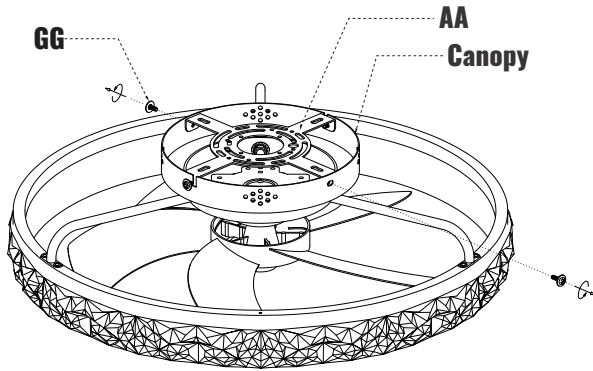

Step 1: Loosen and remove the canopy screws (GG) from the round holes, and loosen the canopy screws (GG) in the 'L' holes but do not remove them, and then remove the mounting bracket (AA) from the canopy.

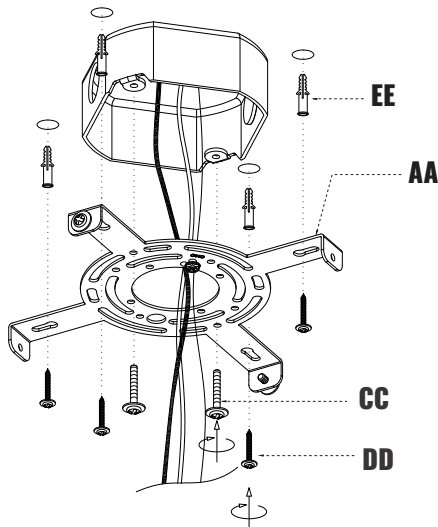

Step 2: Mark and drill screw holes in the ceiling, then insert the long plastic anchors (EE).

Step 3: Use outlet box screws (CC) to fix the mounting bracket (AA) to the outlet box, and then tighten it with long wood screws (DD).

2. Hang the Fan

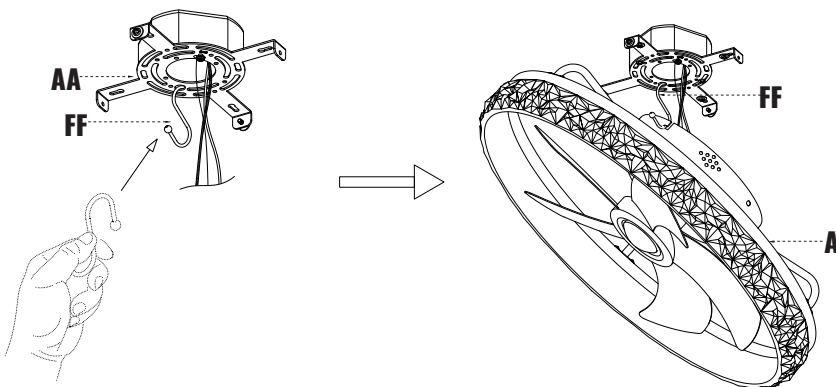

Hang the fixture onto the mounting bracket (AA) with "S" hook (FF) provided.

3. Connect the Wires

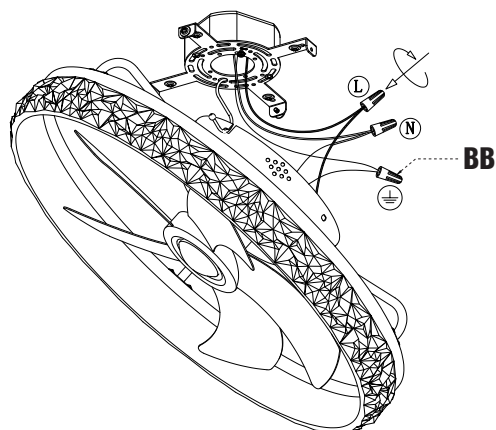

Step 1: Connect the wires from the fan to the house supply wires with wire nuts (BB), ground wire (green, green/yellow, or bare copper) to ground wire, neutral wire (white) to neutral wire, and hot wire (black) to hot wire. Wrap the connection with electrical tape.

Step 2: Spread apart the wires so that the hot wires are on one side of the outlet box and the neutral wires are on the other side.

Note:

This fan only needs one set of input wires (black, white, and ground wire). Both of the fan and lights will be controlled by the remote controller. This fan can only be connected to an on/off switch if you have one, not a dimmer switch.

4. Attach the Canopy

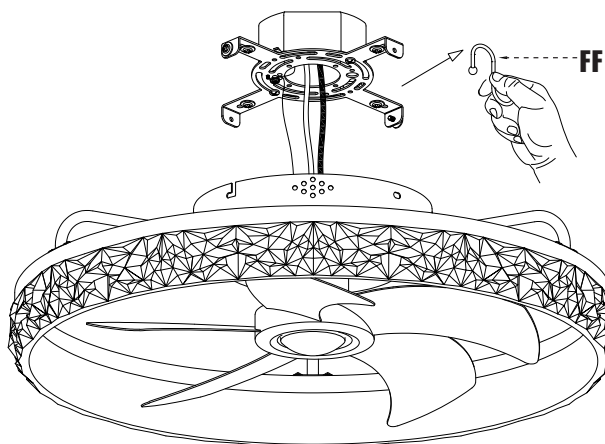

Take away the "S" hook (FF).

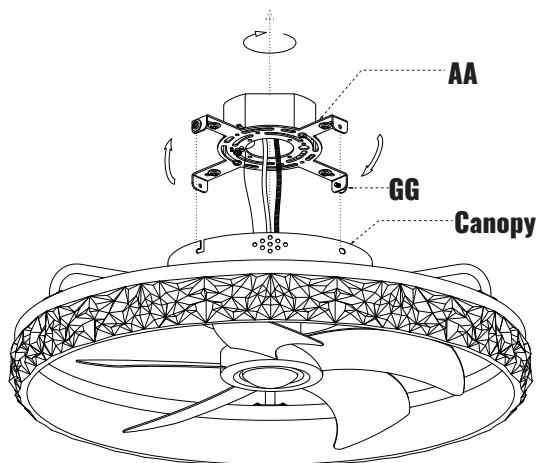

Align the "L" slots from the canopy to the canopy screws (GG) on the mounting bracket (AA), rotate the canopy to lock it onto the mounting bracket (AA).

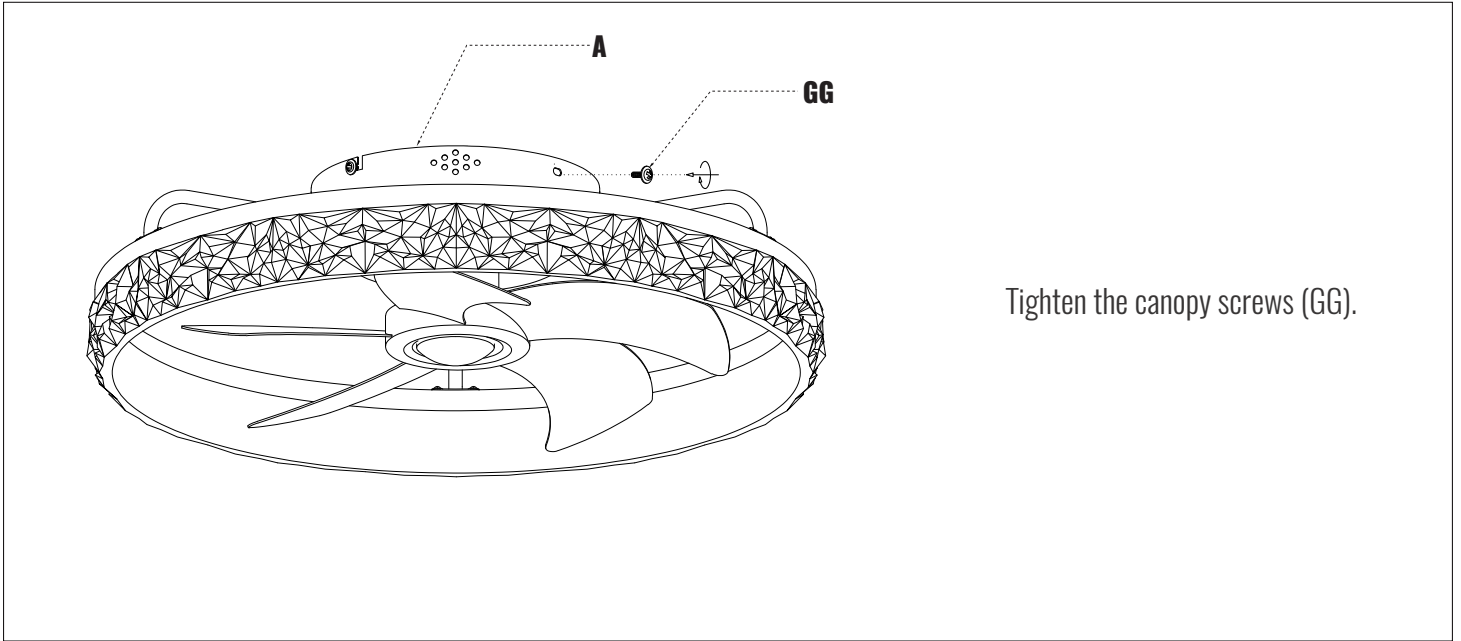

Tighten the canopy screws (GG).

5. Install the Remote Holder

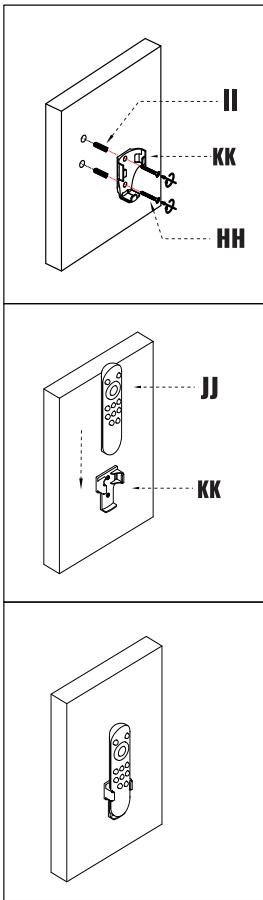
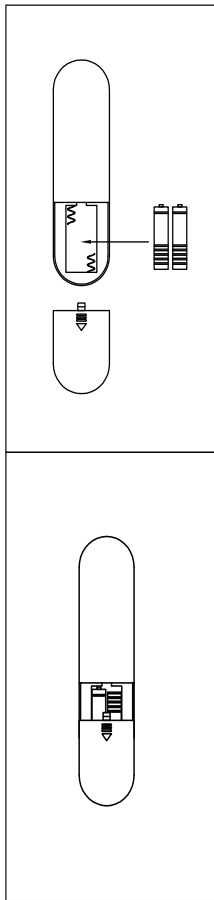

1. Insert 2 batteries before using: AAA 1.5V battery x 2pcs (not included).
2. Mark and drill screw holes in the wall, then insert the short plastic anchors (II).
3. Use short wood screws (HH) to fix the remote holder (KK) onto the wall.

REMOTE CONTROL INSTRUCTIONS

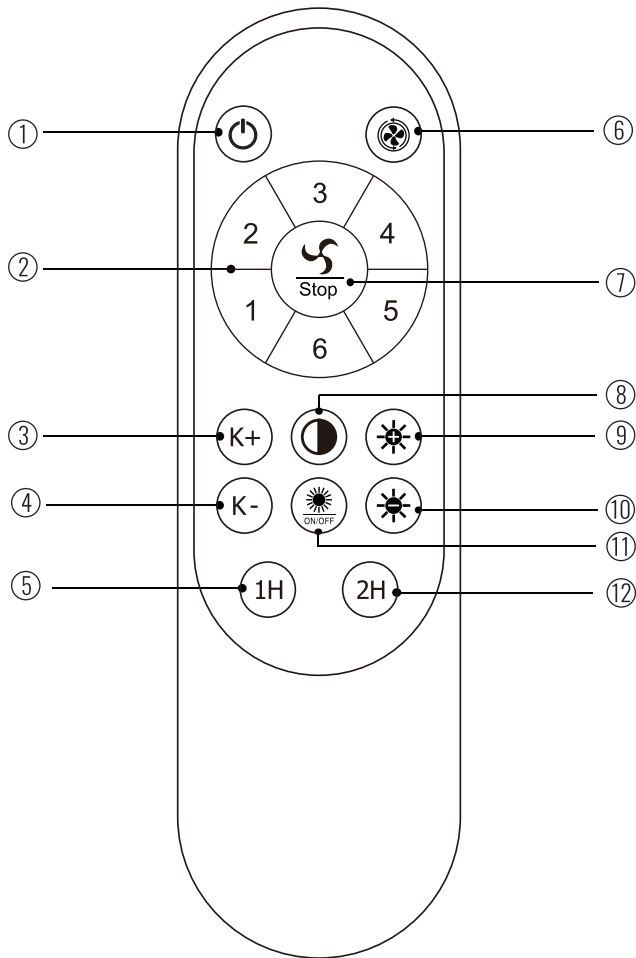

NOTE:

Please insert 2 batteries before using.
AAA 1.5V battery x 2pcs (not included)

- ① : All off.
- ② : 1-6 fan speed.
- ③④ : Adjust the light color temperature.
- ⑤⑫ : Timing the fan.
- ⑥ : Fan moves forwards or reversely.
- ⑦ : Stop the fan.
- ⑧ : Quick switch of the light color: Yellow Light→White Light→Natural Light.
- ⑨⑩ : Adjust the brightness of the light.
- ⑪ : Turn on/off the light.

Remote control matching code: Turn on the power and Press and hold the light pairing key (⑧) within 5 seconds of the light on, When you hear a beep or a light flashes, the code match is successful.

Clear code: Press and hold the 1H key (⑤) at first, then turn on the light and hold for 5 seconds.

APP CONTROL INSTRUCTIONS

Install the "FanLamp Pro" or "Enjoy Home" app from Google Play, Apple App Store, or other app stores by scanning the QR code or searching for the app name. Ensure that your phone is connected to the internet and Bluetooth enabled.







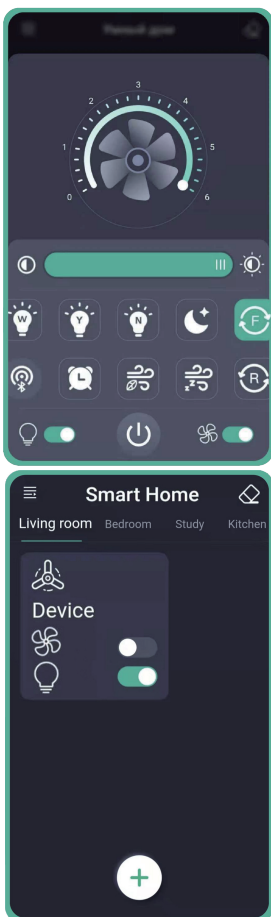









Note: Both apps can be used and their functions are basically the same. Here, we mainly showcase the functions of the **FanLamp Pro**. The functions of the **Enjoy Home** app are also displayed in the manual of the remote control. You can freely choose which smart software to use.



FanLamp Pro



Enjoy home

-  Pairing: Click the Pair button within 5 seconds after turning on the fan from the wall switch. Once the fan flashes or beeps, it has been successfully paired with your phone and can now be controlled through the app.
-  Slide the slider to change the fan speed.
-  Slide the slider to change the brightness of the light.
-  Quick switch for "White" light color.
-  Quick switch for "Yellow" light color.
-  Quick switch for "Natural" light color.
-  Night mode: Dim the lights.
-  Fan moves forward.
-  Fan moves reversely.
-  Change the direction of the wind. (Not supported)
-  Timing the fan.
-  Natural wind: The fan speed will change automatically when you use this function
-  Sleeping wind. (Not supported)
-  Turn on/off the light.
-  Turn on/off the fan.
-  Unpairing: Click the unpair button within 5 seconds after turning on the fan. Once the fan flashes or beeps, it has been successfully unpaired from your phone.