

# INSTALLATION USER MANUAL

THREE FEATURES LARGE SHOWER

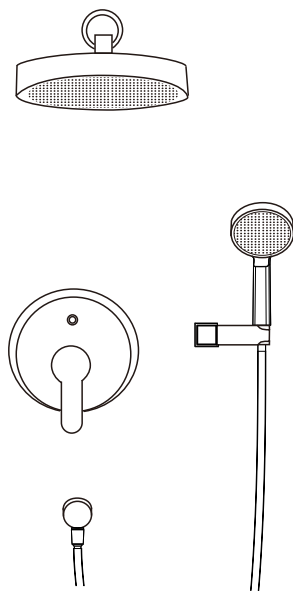

Please read this installation manual and check carefully before installation

## PARTS LIST

### 1. Check the packaging

- ① To ensure smooth installation, check the following components. If there are damaged product packaging, or missing parts, or any other problems, please let us know and we will correct them;
- ② After all parts are counted, please keep them properly.

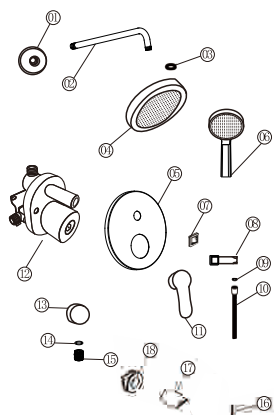

01	Shower arm decorative cover
02	Shower arm
03	Rubber sealing head
04	Top shower
05	Main decorative panel
06	Hand-held shower
07	Trim cover
08	Permanent seat
09	Rubber seal
10	Shower hose
11	Handlebar
12	Valve body
13	Shower socket
14	Rubber ring
15	Shower joint
16	Allen key
17	Specification
18	Teflon tape

## BASIC SIZE

### 2. Determine the installation position and height

Determine its installation location and height based on your height and preferences

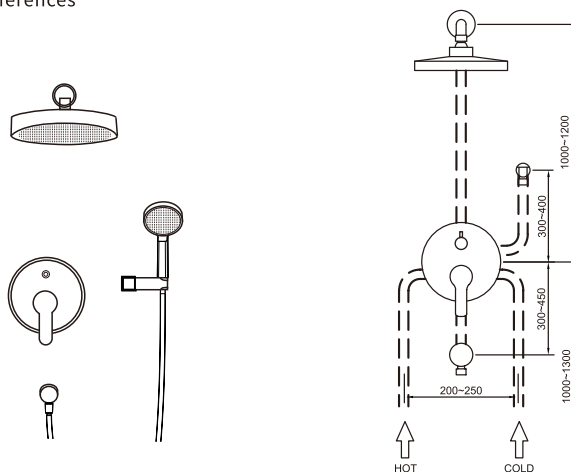

## INSTALLATION PROCEDURE

### 3. Connect the water pipe to the body

- ① Turn off the main water supply in your home;
- ② Mark valve body installation position, cut pipe to appropriate length and install g1/2 adapter fitting on pipe;
- ③ Flush line to ensure there are no impurities in line, then connect hot and cold water line to valve body.

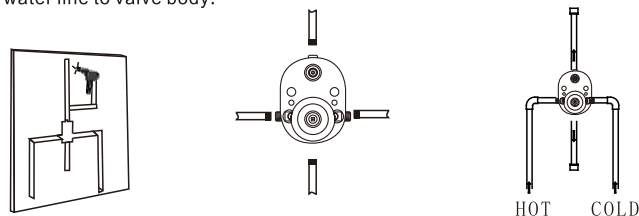

- ④ At the end of the test, plug all pipe outlets, then open the handle to check for connection problems or leakage problems;

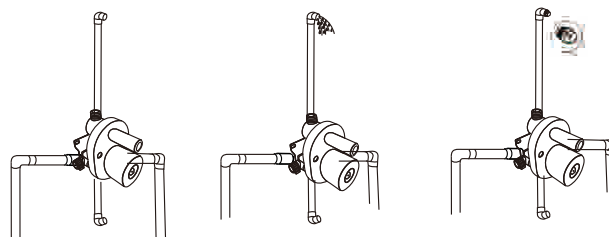

- ⑤ At the end of the test, place the plastic cover on the body until tile is finished to prevent damage to the body.

- ⑥ Install shower arm and top spray

- ⑦ Install shower holder and hand shower

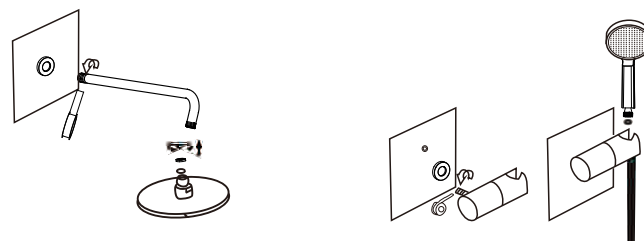

Check that the parts are complete and not broken

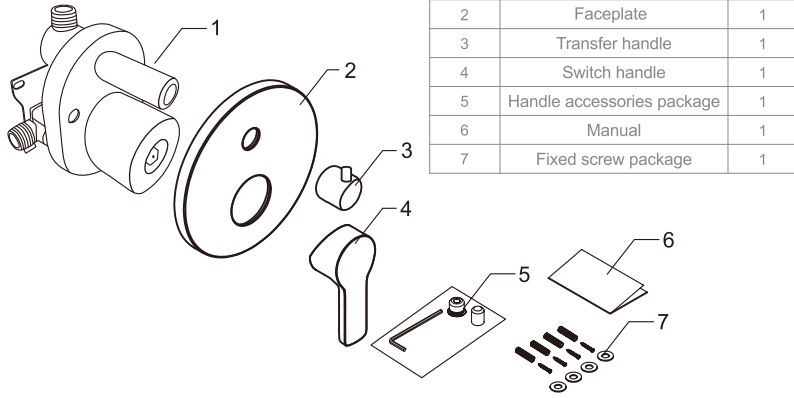

Serial number	Name	Quantity
1	Embedded box	1
2	Faceplate	1
3	Transfer handle	1
4	Switch handle	1
5	Handle accessories package	1
6	Manual	1
7	Fixed screw package	1

Note: The above list shows the type of accessories, functions, specific quantity and appearance of the product purchased shall prevail.

(Basic size)

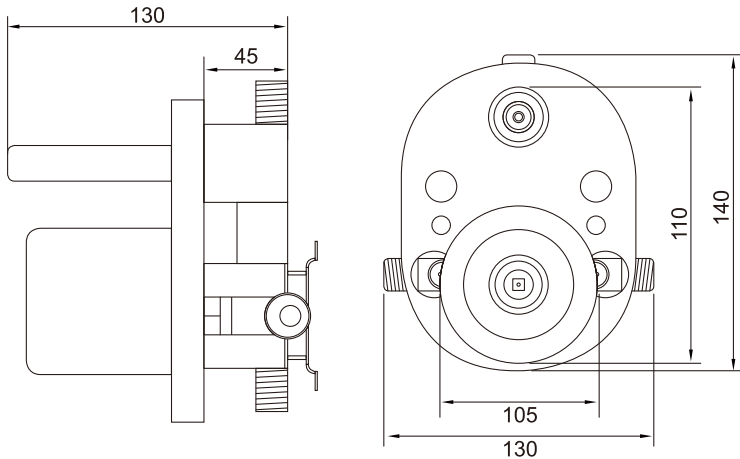

Note: The unit of all size identification or size description in this manual is millimeter (mm)

Installation instructions Solid wall installation

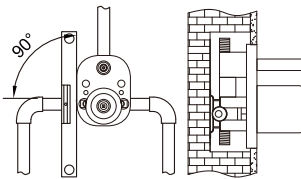
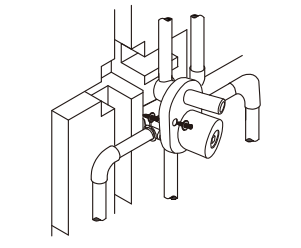
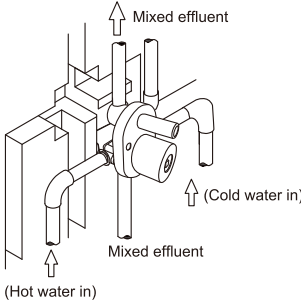
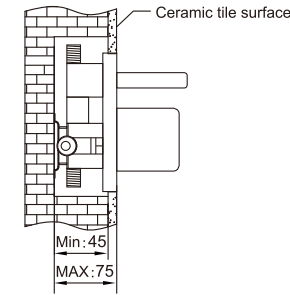

1. According to the basic size of the embedded box, use special tools on the solid wall. When opening the main hole, the depth of the opening is shown in the figure. The distance between the surface after the final treatment of the wall and the bottom of the opening should be 60-75. For example, if the thickness of the blank wall increases by about 20 after the tile surface is paved, the depth of the blank wall should be 40-55.

2. The size of the opening should follow the principle of easy installation with the embedded box;

3. The bottom surface of the opening should be kept flat so that the vertical and horizontal of the embedded box can be adjusted later;

4. According to the connection pipeline of the single function embedded box, pay attention to the upper, lower, left and right directions of the embedded box. The left side is connected with the hot water pipe, the right side is connected with the cold water pipe, and the upper part is connected with the mixed water outlet pipe;

5. For example, embedded box with single control function and outlet pipe of upper mixing box (the actual purchased products shall prevail);

6. After the pipe connection is completed, the corresponding pipe groove is opened on the blank wall according to the pipe layout;

7. Before fixing the embedded box, it is necessary to conduct water test and pipe cleaning for the embedded box and connecting pipe. Before the test, the upper mixing outlet channel should be open;

8. Before testing, open the switch spool and open the water to test whether the right and left water inlet pipes are tight and leakless. After the inlet pipe is tested, the flow switch is turned on to test whether the mixed boiling water pipe is connected with no leakage, while maintaining a period of time to clean and manage the foreign matters to prevent the water outlet function of the control valve.

9. According to the embedded box, the embedded box is fixed on the wall with self tapping screw;

10. The horizontal direction and vertical direction of the embedded box shall be corrected with a parallel ruler, so that the embedded box is as horizontal as possible to the ground and 90° to the wall surface; if not, the installation effect of the control valve panel will be affected;

Installation instructions Solid wall installation

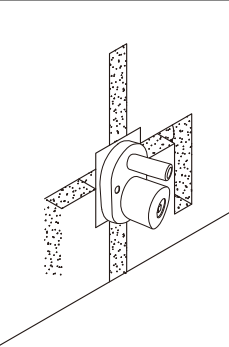

11. Re confirm that the pipeline connection is correct and there is no leakage in the water test. After other embedded components of the shower are installed, the embedded box and pipeline are sealed and fixed with fillers;

12. So far, the installation of the embedded box of solid wall is completed, and the subsequent control valve can be installed after the wall is laid.

⚠ Note: seal the wall after the pipe connection is correct and there is no leakage

Installation instructions Solid wall installation

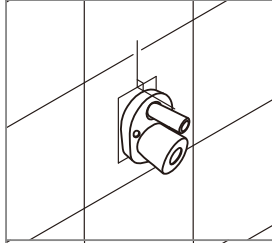

1. Lay the wall tiles or other decorative walls, keep the wall flat and vertical to the embedded box at 90° and make the embedded box in the middle of the single tile as far as possible;

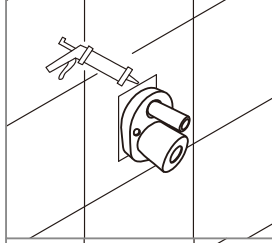

2. Glass glue is applied along the edge of the protruding part of the embedded box to improve the waterproof performance and prolong the service life of the embedded box;

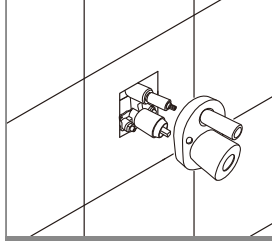

3. Remove the cover plate of embedded box and water test component (as shown in the picture)

Installation instructions

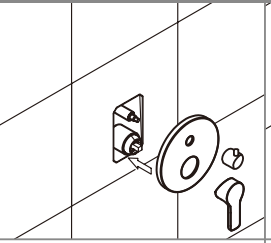

7. Install the control valve panel. Before installation, check whether the protective rubber sleeve at the panel hole falls off. If the protective rubber sleeve is not installed directly into the panel, it is easy to scratch the panel;

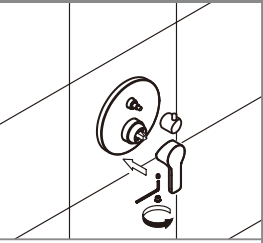

8. Install the switch handle, fix the switch handle on the valve core of the main body of the control valve clockwise with the small hexagon wrench provided by the package, and install the decorative rubber plug;

Function description of control valve

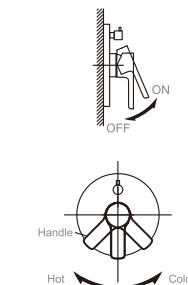

1. When the handle is opened upward as the main switch, the opening angle indicates the flow rate;

2. Swing the handle left and right to adjust the mixing water temperature. Swing it to the left, the hot water inlet flow increases, the cold water inlet flow decreases, and the water temperature increases; conversely, swing to the right, the hot water inlet flow decreases, the cold water inlet flow increases, and the water temperature decreases;

3. The water distribution switch controls the direction of the mixed water. When the indicator of the water distribution switch is upward, it indicates that the mixed water is coming out of the upper pipe. When the water distribution switch is rotated 90 degrees anticlockwise and points to the left, it indicates that the mixed water is coming out of the lower pipe (the single function control valve does not have this function)

To keep the outside surface of the tap bright and good performance, please care for the faucet as follows:

- Rinse with water and dry with soft cotton cloth;
- Mild liquid and colorless glass cleaner can be used to remove dirt and scale film on the surface. Polishing agent with grinding effect is not allowed;
- Do not use abrasive cleaner, polish, emery cloth, paper towel or scraper, etc;
- Do not use acid cleaner, insoluble granular cleaner and soap;
- In the process of use, the bubbler may accumulate dirt, which makes the water rheology small and slow down. The bubbler can be unscrewed, washed with water, and then installed back to its original position.

