

- PL Instrukcja montażu
- DE Montageanleitung
- NL Handleiding voor de montage
- TR Montaj talimatı
- FR Notice de montage
- CZ Montážní návod
- HU Szerelési útmutató
- GB Assembly instructions
- RU Инструкция по монтажу
- IT Istruzioni di montaggio
- SK Návod na montáž
- RO Instrucțiuni de montaj
- ES Instrucciones de montaje
- PT Instruções de montagem

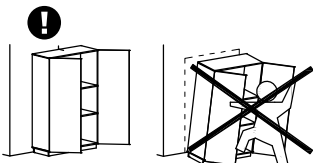

2025-01-16

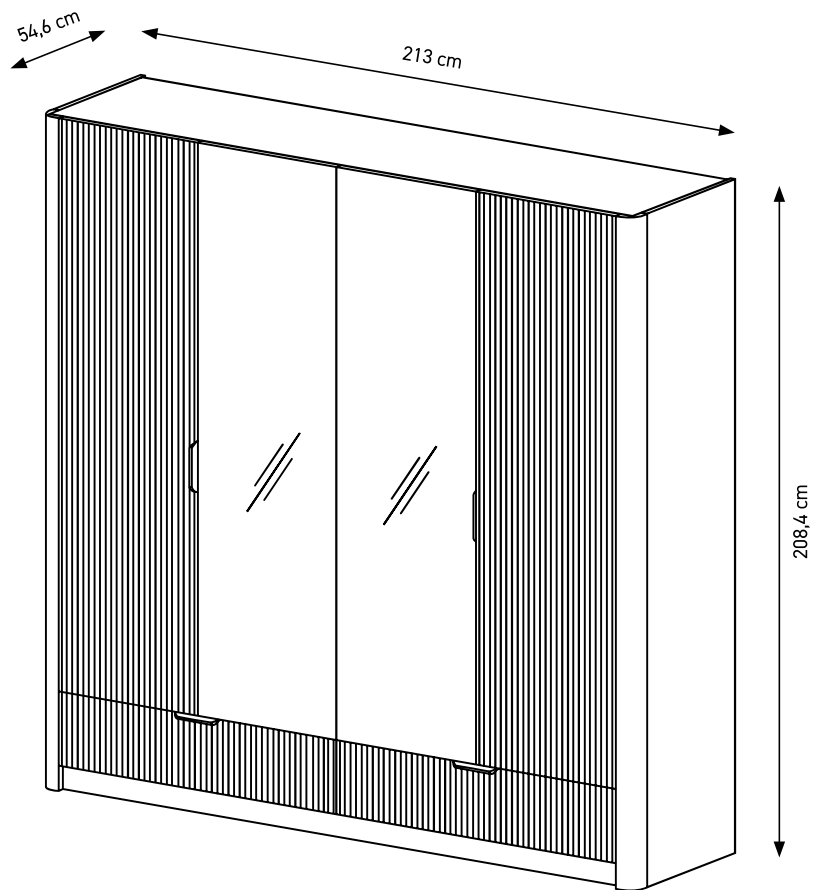

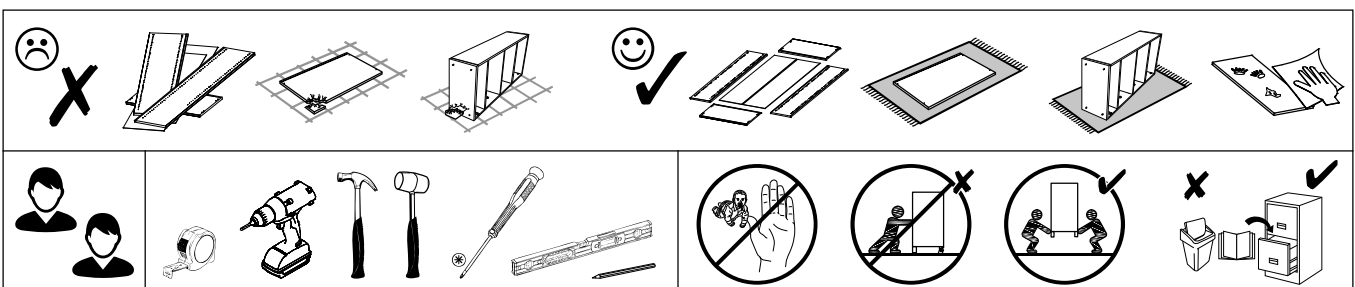

PL Przed rozpoczęciem montażu mebla wszystkie elementy należy sprawdzić czy nie są uszkodzone. W przypadku wykrycia uszkodzenia elementu należy odstąpić od montażu mebla i złożyć reklamację. Nie wolno przekraczać podanych maksymalnych wartości obciążenia. W innym przypadku można mebel uszkodzić lub zniszczyć.

Przed zawieszeniem mebla, lub przymocowaniem go do ściany (w celu zabezpieczenia przed przewróceniem), sprawdź wcześniej rodzaj i wytrzymałość ściany. Dobierz odpowiednie kotki i wkręty do rodzaju ściany. W przypadku wątpliwości skontaktuj się ze specjalistą. Montaż musi zostać wykonany przez osobę kompetentną. Meble zawierające płyty drewnopochodne mogą emitować substancje zanieczyszczające do powietrza w pomieszczeniu. Dlatego zaleca się, po zamontowaniu mebli, częste wietrzenie pomieszczenia przez co najmniej cztery tygodnie.

DE Vor Beginn der Möbelmontage sollten alle Elemente auf Beschädigungen überprüft werden. Wenn ein Element des Produkts beschädigt ist, installieren Sie das Produkt bitte nicht und reichen Sie eine Beschwerde ein. Überschritten Sie die angegebenen Maximalbelastungen nicht. Andernfalls kann das Möbelstück beschädigt oder zerstört werden.

Bevor Sie ein Möbelstück an einer Wand aufhängen oder befestigen (um es gegen Umkippen zu sichern), prüfen Sie Art und Tragfähigkeit der Wand. Wählen Sie die für die Wand geeigneten Dübel und Schrauben. Im Zweifelsfall kontaktieren Sie bitte einen Fachmann. Die Montage muss durch eine sachkundige Person ausgeführt werden.

Möbel mit Holzwerkstoffplatten können Schadstoffe in die Raumluft abgeben. Daher Es wird empfohlen, den Raum nach dem Einbau der Möbel mindestens vier Wochen lang häufig zu lüften.

FR Avant de commencer l'assemblage du meuble, tous les éléments doivent être vérifiés pour déceler tout dommage. Si un élément du produit est endommagé, veuillez ne pas installer le produit et déposer une plainte. Ne dépassez pas les charges maximum indiquées. Sinon, le meuble peut être endommagé ou détruit.

Avant de suspendre le meuble ou de le fixer au mur (dans le but d'éviter un renversement), vérifiez au préalable le type et la résistance du mur. Utilisez les chevilles et les vis adaptées au type de mur. En cas de doute, veuillez contacter un spécialiste. Le montage doit être réalisé par une personne compétente.

Les meubles contenant des panneaux à base de bois peuvent émettre des substances polluantes dans l'air intérieur. Donc il est recommandé, après l'installation des meubles, d'aérer fréquemment la pièce pendant au moins quatre semaines.

CZ Před zahájením montáže nábytku je třeba zkontrolovat poškození všech prvků. Pokud je některý prvek produktu poškozen, zdržte se instalace produktu a podjeďte stížnost. Nepřekračujte uvedené maximální zatížení. V opačném případě může dojít k poškození nebo zničení nábytku.

Před zavěšením nábytku nebo jeho připevněním ke zdi (za účelem zajištění před převrácením) dřívě zkontrolujte druh a odolnost stěny. Vyberte k druhu stěny vhodné hmoždinky a šrouby. V případě pochybností kontaktujte specialistu. Montáž musí být provedena kompetentní osobou. Nábytek obsahující panely na bázi dřeva může uvolňovat znečišťující látky do vnitřního ovzduší. Proto doporučujeme se po instalaci nábytku místnost pravidelně větrat po dobu nejméně čtyř týdnů.

HU A bútor szerelés megkezdése előtt ellenőrizni kell az összes elem sérülését. Ha a termék bármely eleme megsérült, kérjük, tartózkodjon a termék telepítésétől és nyújtson be panaszt. A megadott maximális terhelési értékeket nem szabad túllépní. Ellenkező esetben a bútor megsérülhet vagy megsemmisülhet.

A bútor felüggesztése illetve falhoz való rögzítése (megakadályozva ezzel eldőlésének lehetőségét) előtt ellenőrizze a fal fajtáját és szilárdságát. Megfelelő, a falhoz illő tipűket és csavarokat használjon. Ha kétsége támadna, konzultáljon szakemberrel. A felszerelést csak egy hozzáértő szakember végezheti el. A fa alapú paneleket tartalmazó bútorok szennyező anyagokat bocsáthatnak ki a beltéri levegőbe. Ezért Ajánlott a bútorok beszerelése után legalább négy hétig rendszeresen szellőztetni a helyiséget.

GB Before starting the furniture assembly, all elements should be checked for damage. If any element of the product is damaged, please refrain from installing the product and file a complaint. The specified maximum load values must not be exceeded. Otherwise, the piece of furniture may be damaged or destroyed.

Before suspending or fixing furniture to the wall (in order to prevent falling over), check the type and strength of the wall. Select wall plugs and screws appropriate for the given type of the wall. In the case of doubts, contact a specialist. The installation must be performed by a competent person.

Furniture containing wood-based panels can emit polluting substances into the indoor air. Therefore recommend, after installing the furniture, to ventilate the room frequently for at least four weeks.

SK Pred začatím montáže nábytku by sa mali skontrolovať všetky prvky, či nie sú poškodené. Ak je niektorý prvok výrobku poškodený, neinštalujte výrobok a reklamujte ho.

Uvedené hodnoty maximálneho zaťaženia nesmú byť prekročené. V opačnom prípade môže dôjsť k poškodeniu alebo zničeniu nábytku.

Pred zaviesaním nábytku alebo jeho pripavením na stenu (za účelom zaistenia pred prevrátením) predtým skontrolujte druh a odolnosť steny. Vyberte k druhu steny vhodné hmoždinky a skrutky. V prípade pochybností kontaktujte špecialistu. Montáž musí byť vykonaná kompetentnou osobou.

Nábytok obsahujúci dosky na báze dreva môže vyľučovať znečisťujúce látky do vnútorného ovzdušia. Preto odporúča sa po inštalácii nábytku miestnosť pravidelne vetrať aspoň štyri týždne.

IT Prima di iniziare l'assemblaggio del mobile, tutti gli elementi dovrebbero essere controllati per danni. Se qualche elemento del prodotto è danneggiato, astenersi dall'installare il prodotto e presentare un reclamo.

I valori di carico massimo specificati non devono essere superati. In caso contrario, il mobile potrebbe essere danneggiato o distrutto.

Prima di appendere i mobili oppure attaccarli al muro (per proteggerli da ribaltamenti), verifica prima la tipologia e resistenza del muro. Scegli i tasselli e viti più adatti per il tipo di muro. In caso di dubbi contattare uno specialista. Il montaggio deve essere fatto da una persona competente.

I mobili contenenti pannelli a base di legno possono emettere sostanze inquinanti nell'aria interna. Perciò si consiglia, dopo aver installato i mobili, di aerare frequentemente il locale per almeno quattro settimane.

NL Voordat u met de meubelmontage begint, moeten alle elementen op schade worden gecontroleerd. Als een onderdeel van het product beschadigd is, installeer het dan niet en dien een klacht in. Overschrijd de aangegeven maximale belastingen niet. Anders kan het meubelstuk worden beschadigd of vernield.

Voordat u het meubel ophangt of bevestigt tegen de muur (om het te beschermen tegen omvallen) dient u het type en de duurzaamheid van deze muur na te kijken. Maak gebruik van pluggen en schroeven die geschikt zijn voor het type muur. Neem in geval van twijfels contact op met een specialist. De assemblage moet te worden uitgevoerd door iemand met kennis van zaken.

Meubels met panelen op houtbasis kunnen vervuilende stoffen in de binnenlucht uitstoten. Daarom Het is raadzaam om na het plaatsen van het meubilair de ruimte minimaal vier weken regelmatig te ventileren.

TR Mobilya montajına başlamadan önce tüm elemanlarda hasar olup olmadığını kontrol edilmelidir. Ürünün herhangi bir parçası hasar görmüşse, lütfen ürünü kurmayın ve şikayette bulunun.

Belirtilen azami yük değerini aşmayınız, aksi takdirde mobilya parçaları zarar görebilir veya kullanılamaz hale gelebilir.

Mobilyayı duvara asmadan veya montaj etmeden önce (devrilmesini önlemek için) duvarın türünü ve dayanıklılığını kontrol edin. Duvara uygun dübelleri ve vidaları seçin. Emin olamamanız durumunda bir uzman ile iletişime geçin. Kurulum yetkili bir kişi tarafından yapılmalıdır.

Aşağıdaki panelleri içeren mobilyalar iç mekan havasına kirletici maddeler yayarabilir. Böylece Mobilyaların kurulumundan sonra odanın en az dört hafta boyunca sık sık havalandırılması önerilir.

RO Înainte de a începe asamblarea mobilierului, toate elementele trebuie verificate pentru a nu se deteriorează. Dacă vreun element al produsului este deteriorat, vă rugăm să vă abțineți de la instalarea produsului și să depuneți o reclamație.

Valoriile maxime de sarcină specificate nu trebuie depășite. În caz contrar, piesa de mobilier poate fi deteriorată sau distrusă.

Înainte de suspendarea unei piese de mobilier sau atașarea acestuia la perete (pentru a preveni bascularea), verificați în prealabil tipul și gradul de rezistență a peretelui. Montați diblurile și șuruburile adecvate pentru tipul de perete. În caz de îndoieli, consultați un specialist. Instalarea trebuie să fie efectuată de către o persoană competentă.

Mobilierul care conține panouri pe bază de lemn poate emite substanțe poluante în aerul interior. Prin urmare se recomandă ca, după montarea mobilierului, aerisirea frecventă a încăperii timp de cel puțin patru săptămâni.

ES Antes de comenzar el montaje de los muebles, todos los elementos deben comprobarse en busca de daños. Si algún elemento del producto está dañado, absténgase de instalar el producto y presente una queja.

No se deben exceder los valores de carga máxima especificados. De lo contrario, el mueble puede dañarse o destruirse.

Antes de colgar o fijar el mueble en el muro (a fin de proteger contra el vuelco del mueble), compruebe de antemano la naturaleza y la resistencia de la pared. Seleccione tacos y tornillos adecuados para el tipo de la pared. En caso de duda, consulte a un especialista, debiendo efectuar este montaje una persona competente.

Los muebles que contienen paneles de madera pueden emitir sustancias contaminantes al aire interior. Por lo tanto se recomienda, después de instalar los muebles, ventilar la habitación con frecuencia durante al menos cuatro semanas.

PT Antes de iniciar a montagem do móvel, todos os elementos devem ser verificados quanto a danos. Se algum elemento do produto estiver danificado, evite instalar o produto e apresente uma reclamação. Os valores de carga máxima especificados não devem ser excedidos. Caso contrário, o móvel pode ficar danificado ou destruído.

Antes de suspender ou fixar móveis à parede (para evitar quedas), verifique o tipo e a resistência da parede. Seleccione buchas e parafusos adequados ao tipo de parede. Em caso de dúvidas contacte um especialista. A instalação deve ser realizada por uma pessoa competente.

Os móveis que contenham painéis de madeira podem emitir substâncias poluentes para o ar interior. Assim, recomenda-se, após a instalação dos móveis, ventilar o ambiente frequentemente durante pelo menos quatro semanas.

RU Прежде чем приступить к сборке мебели, следует проверить все элементы на предмет повреждений. Если какой-либо элемент продукта поврежден, воздержитесь от установки продукта и подайте жалобу.

Указанные максимальные значения нагрузки превышать нельзя. В противном случае предмет мебели может быть поврежден или разрушен.

Прежде чем подвешивать или крепить мебель к стене (во избежание падения), проверьте тип и прочность стены. Выбирайте дюбели и шурупы, подходящие для данного типа стены. В случае сомнений обратитесь к специалисту. Установка должна выполняться компетентным лицом.

Мебель, состоящая из древесных плит, может выделять загрязняющие вещества в воздух в помещении. Поэтому рекомендуется после установки мебели часто проветривать помещение в течение как минимум четырех недель.

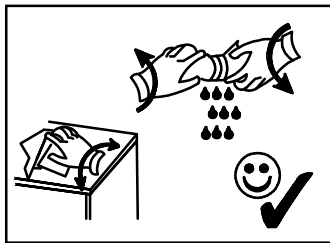
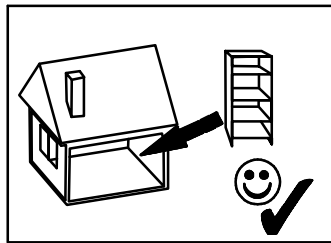
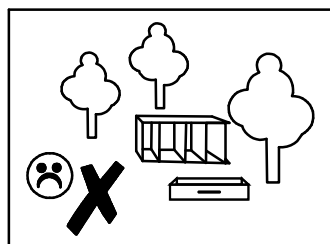
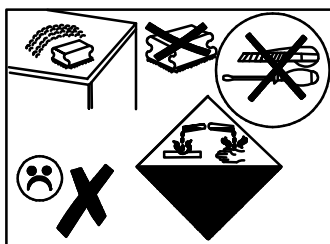
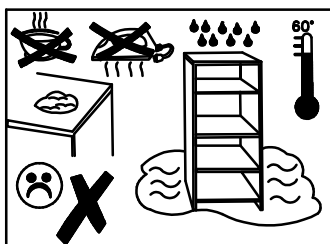
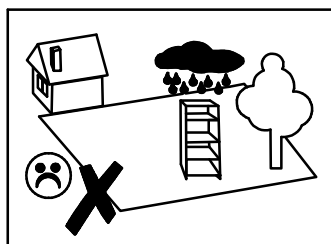

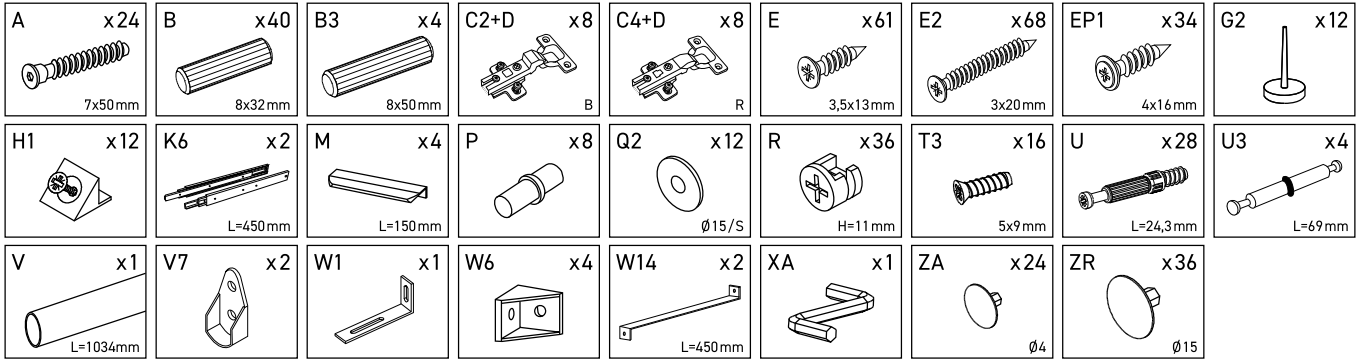

H-1	2098	505	16	x1	2/5
H-2	2098	505	16	x1	2/5
H-3L	1041	505	16	x1	3/5
H-3R	1041	505	16	x1	3/5
H-4L	1041	505	16	x1	3/5
H-4R	1041	505	16	x1	3/5
H-5	1041	490	16	x2	3/5
H-6	2080	480	16	x1	1/5
H-7	2080	480	16	x1	1/5
H-8	1968	505	16	x1	1/5
H-9L	218	505	16	x1	1/5
H-9R	218	505	16	x1	1/5
H-10L	2080	65	65	x1	1/5
H-10R	2080	65	65	x1	1/5
H-11	2098	80	16	x2	2/5
H-12	496	1770	16	x2	4/5
H-13	496	1770	18	x2	5/5
H-14	996	226	18	x2	2/5
H-15	928	150	16	x2	2/5
H-16	450	150	16	x2	1/5
H-17	450	150	16	x2	1/5
H-18	958	456	3	x2	1/5
H-19	1056	1997	3	x2	2/5

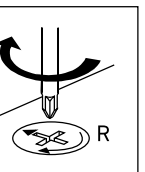
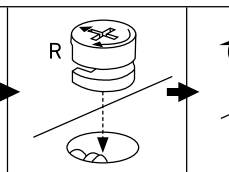
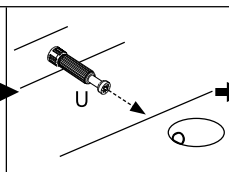
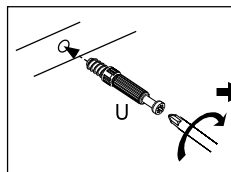
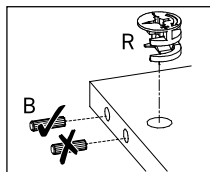
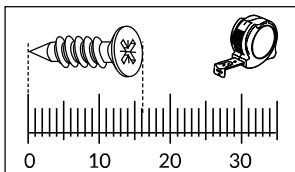
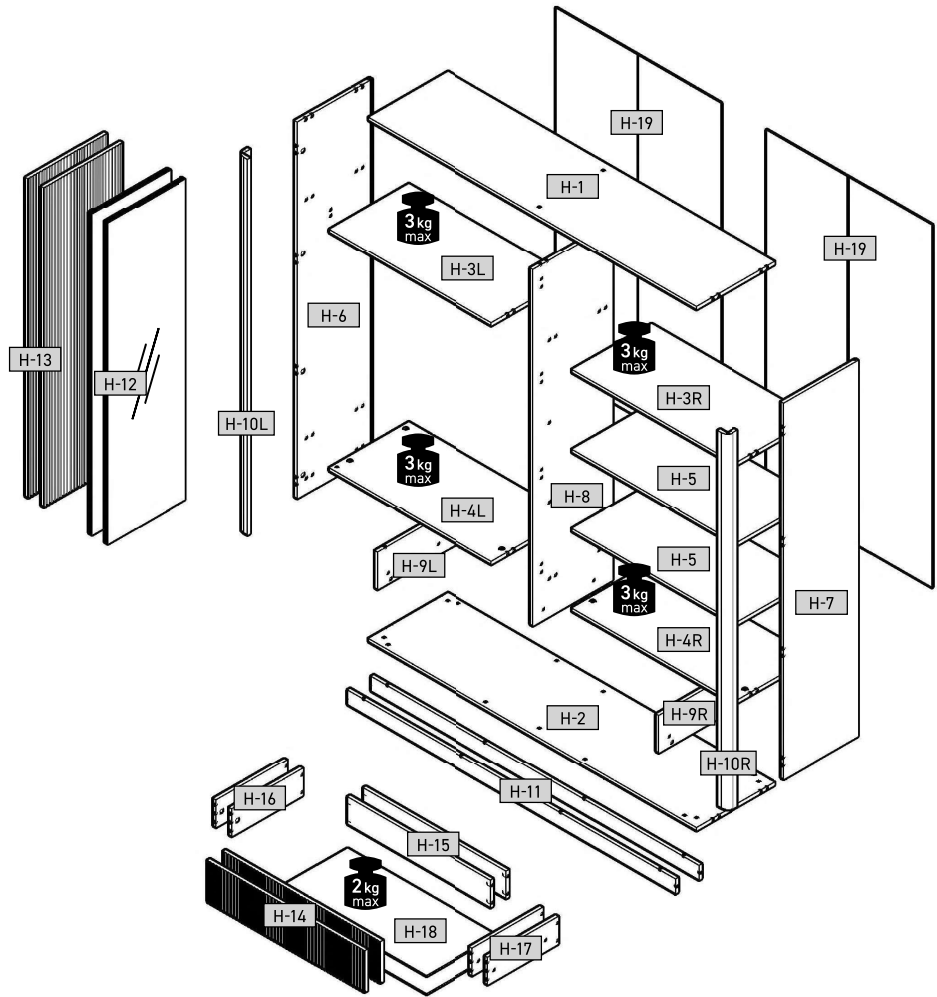



1

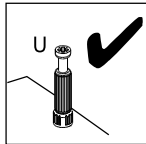
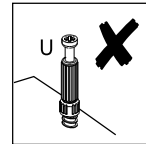
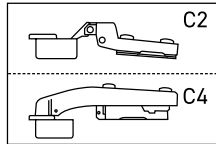
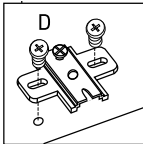
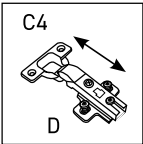
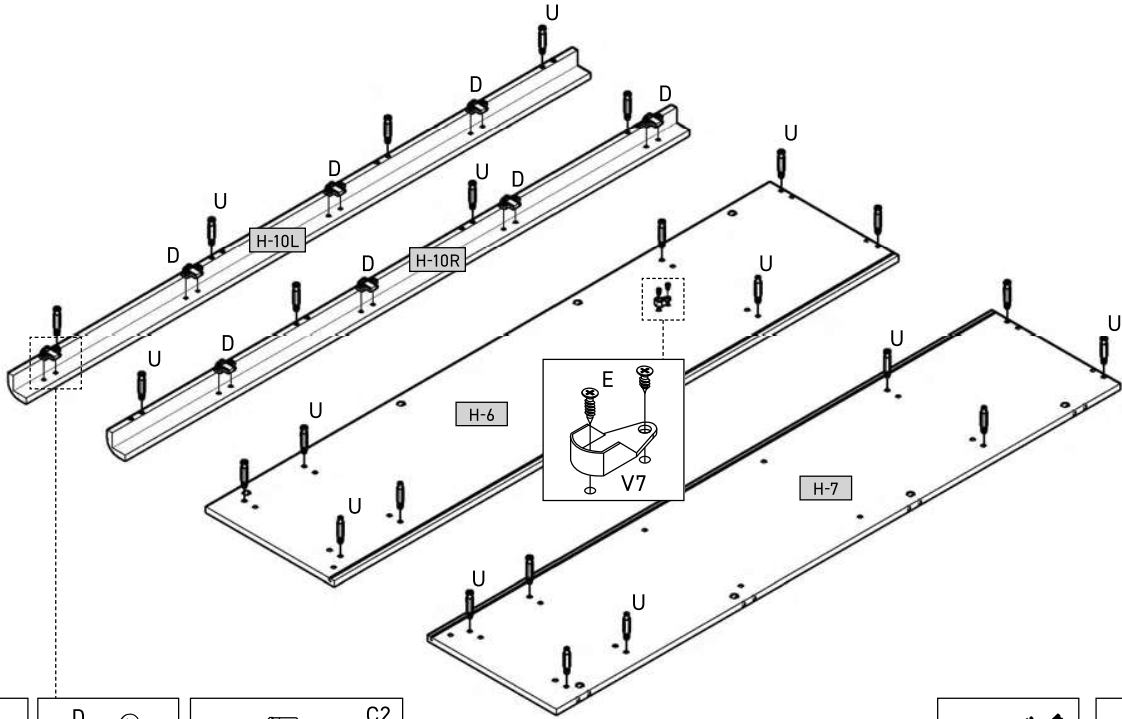
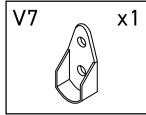
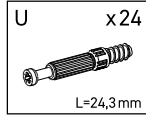
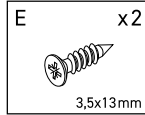
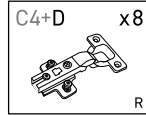

2

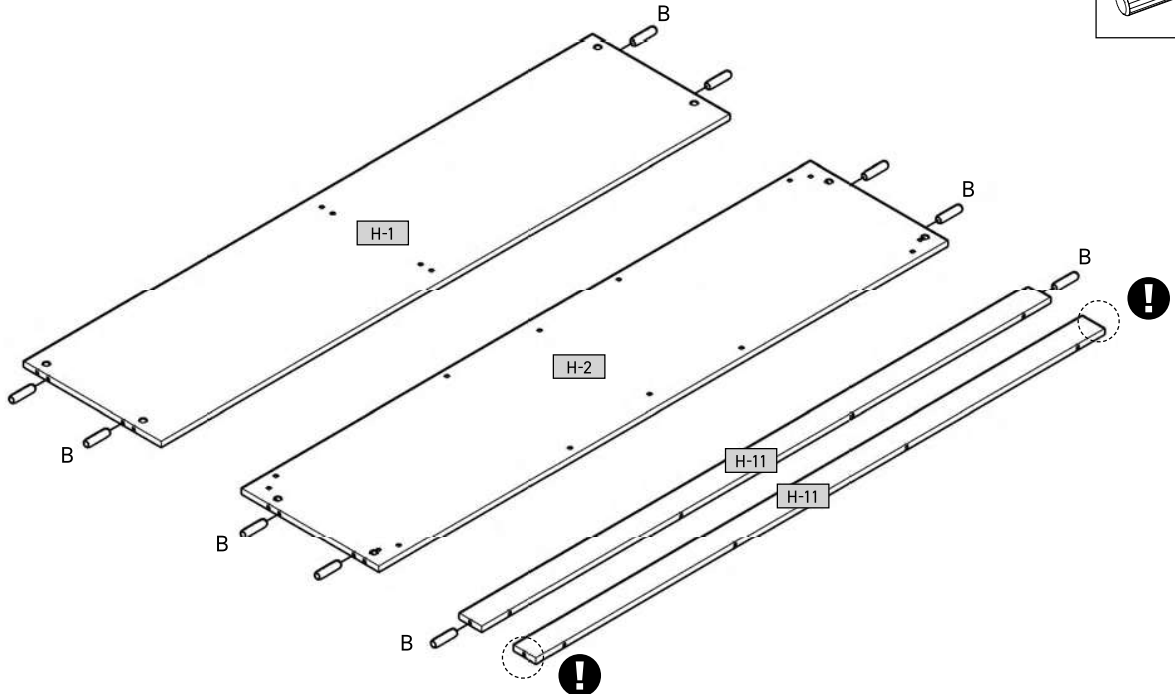
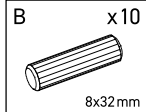



3

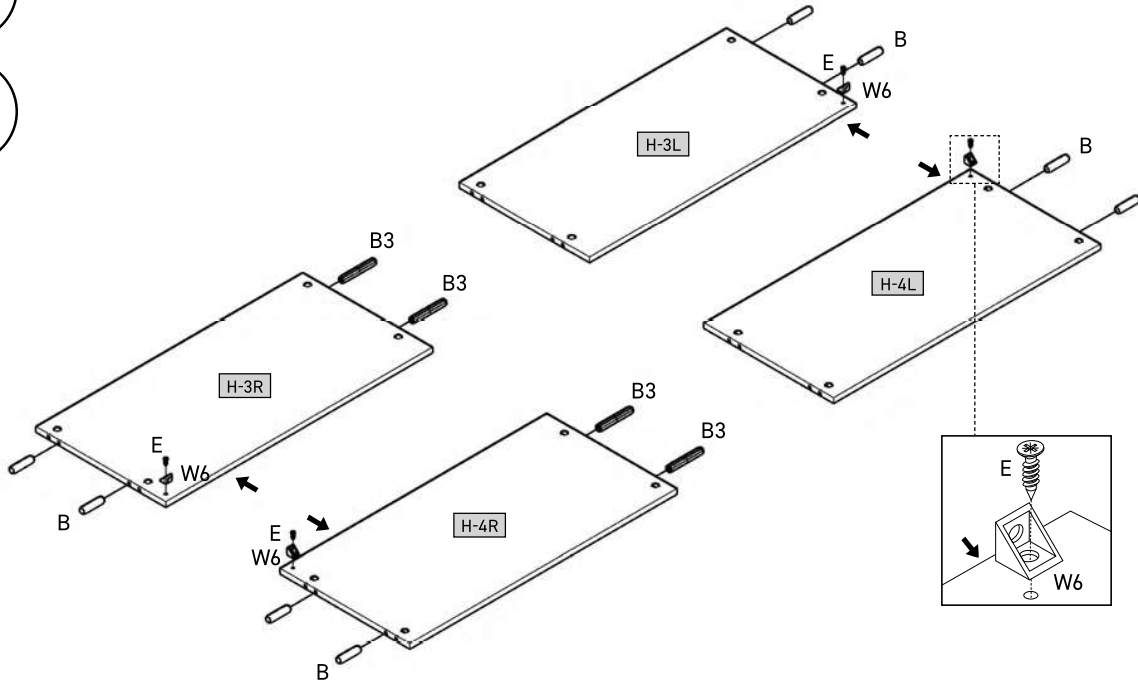
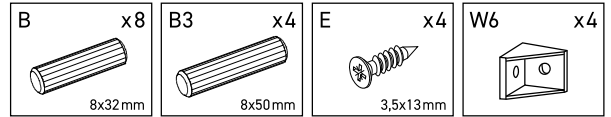
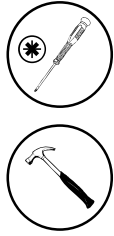

4

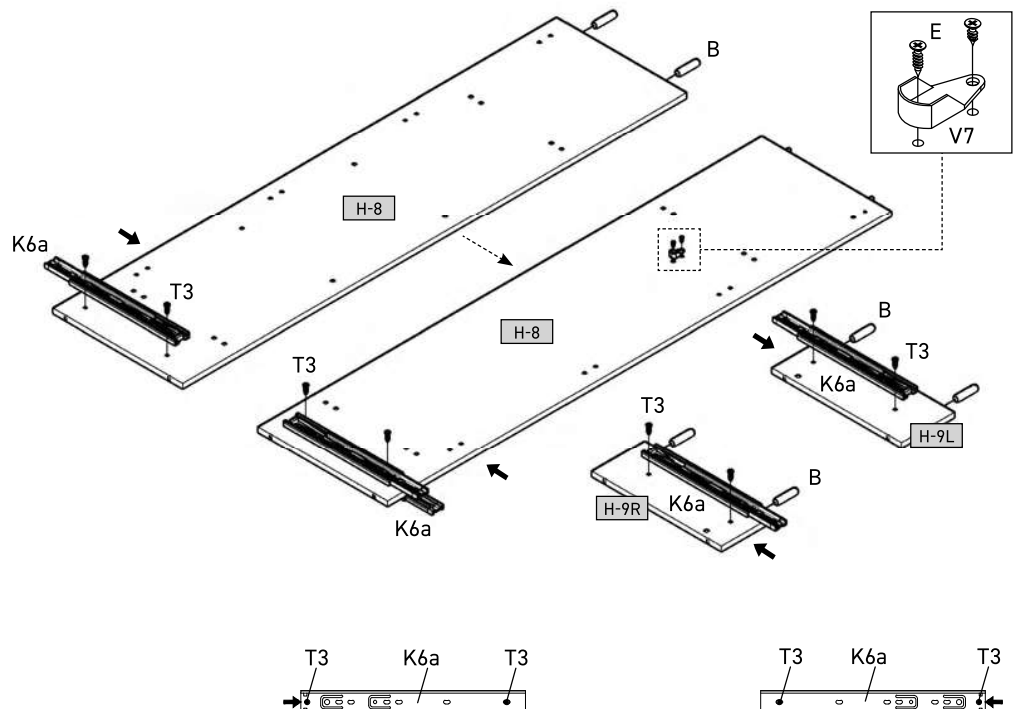
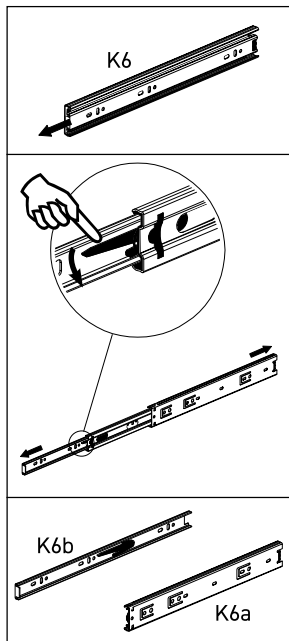
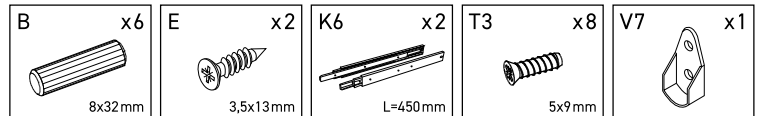
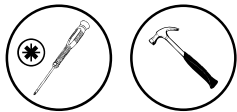



5

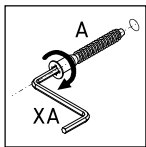
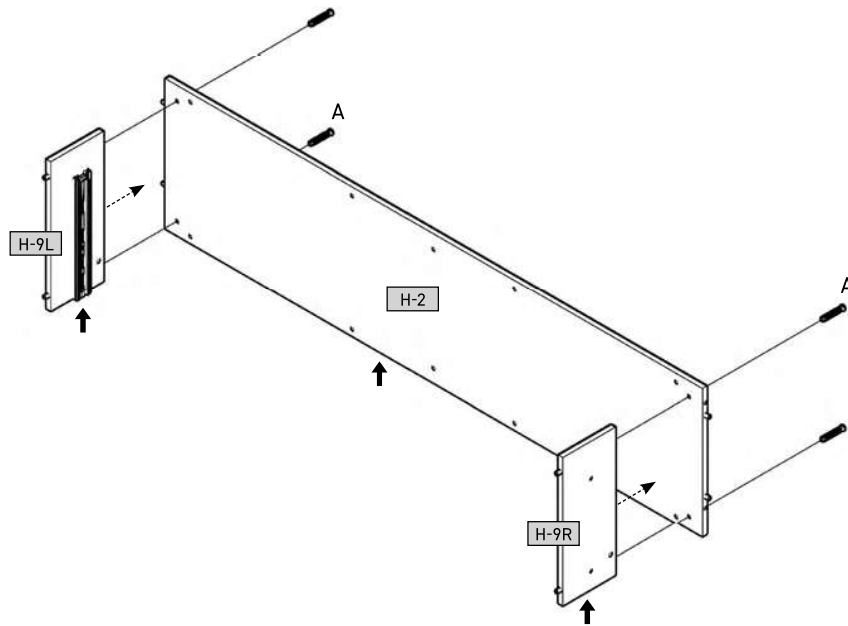
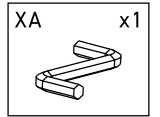
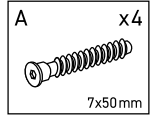

6

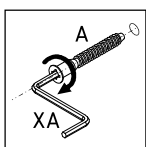
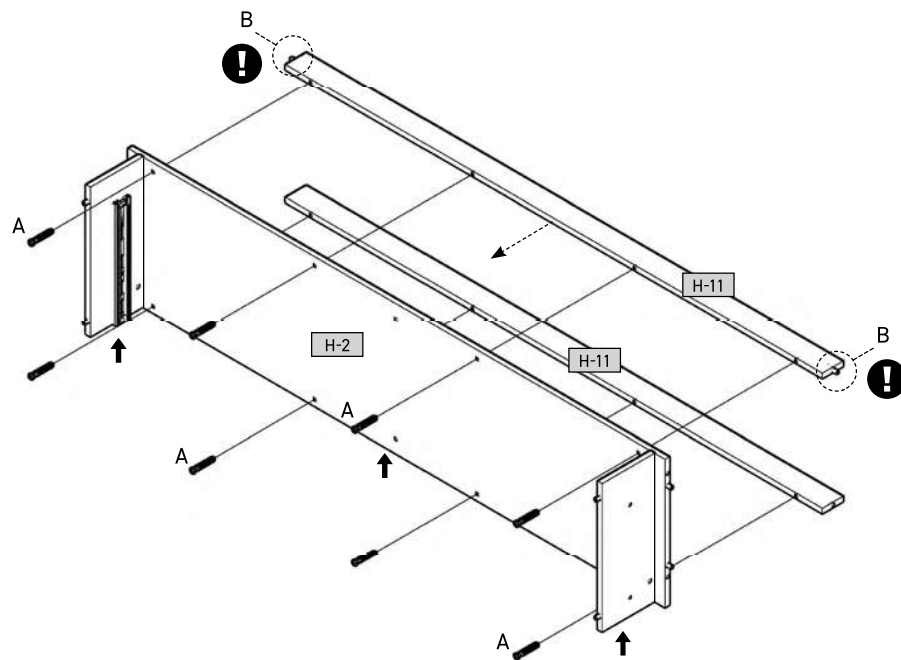
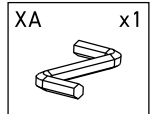
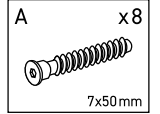



7

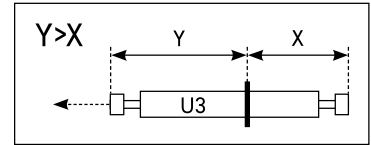
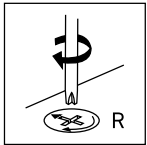
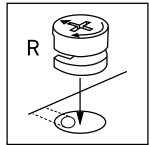
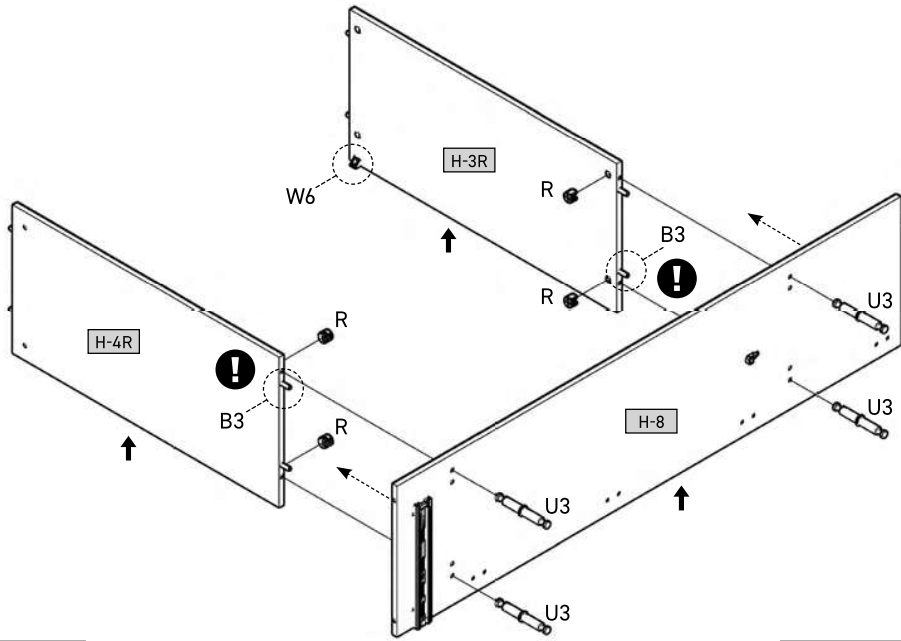
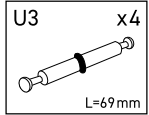
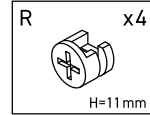

8

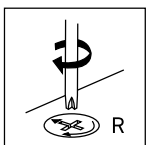
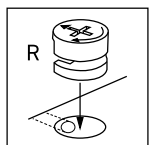
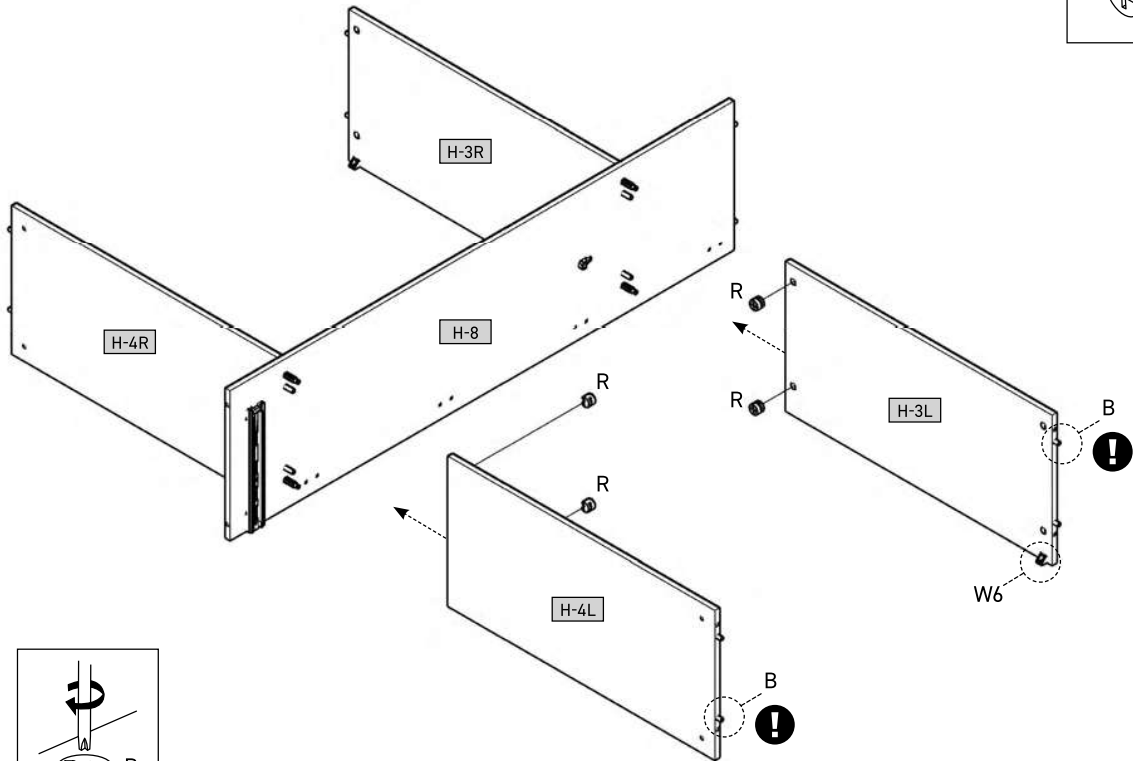
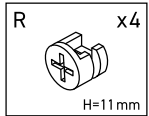



9

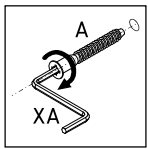
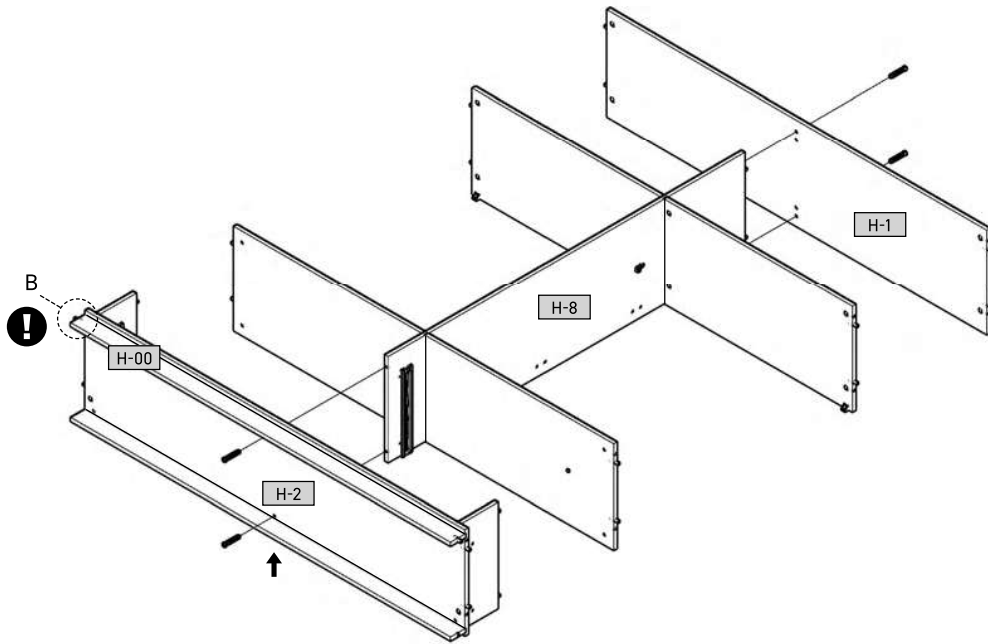
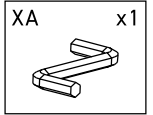
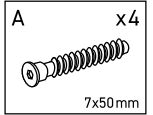

10

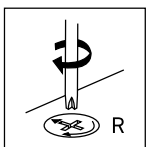
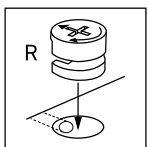
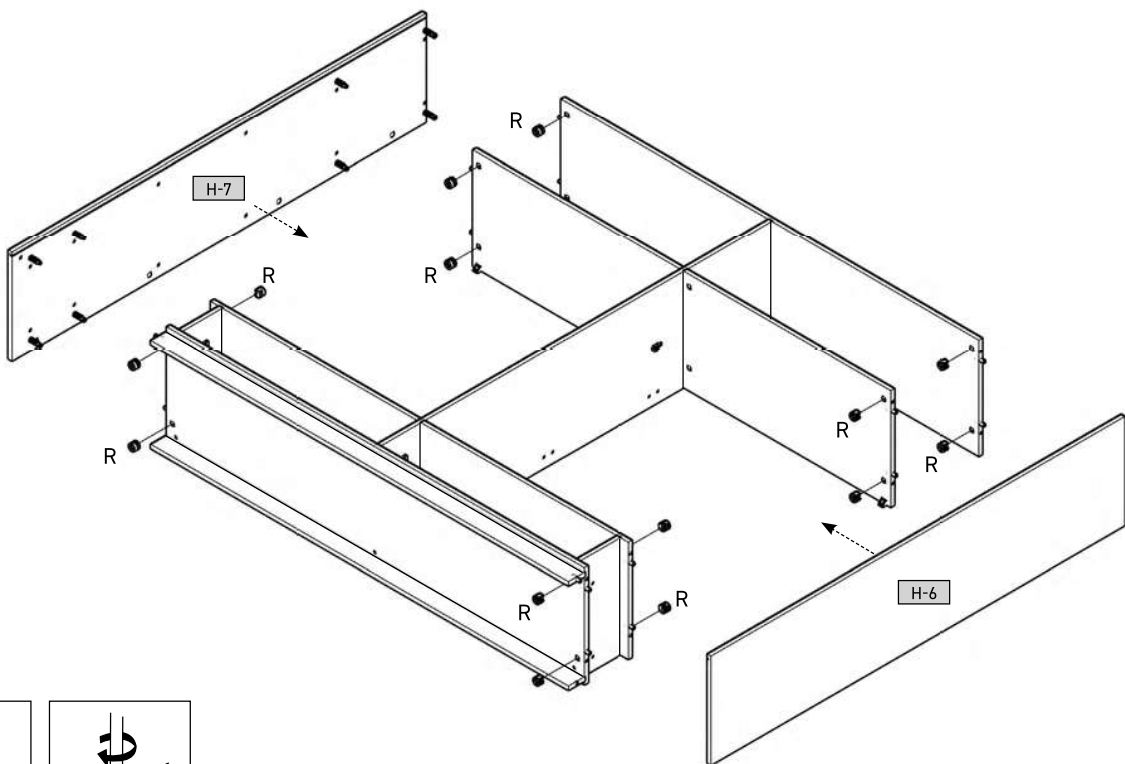
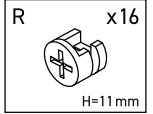



11

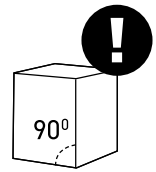
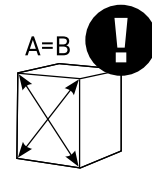
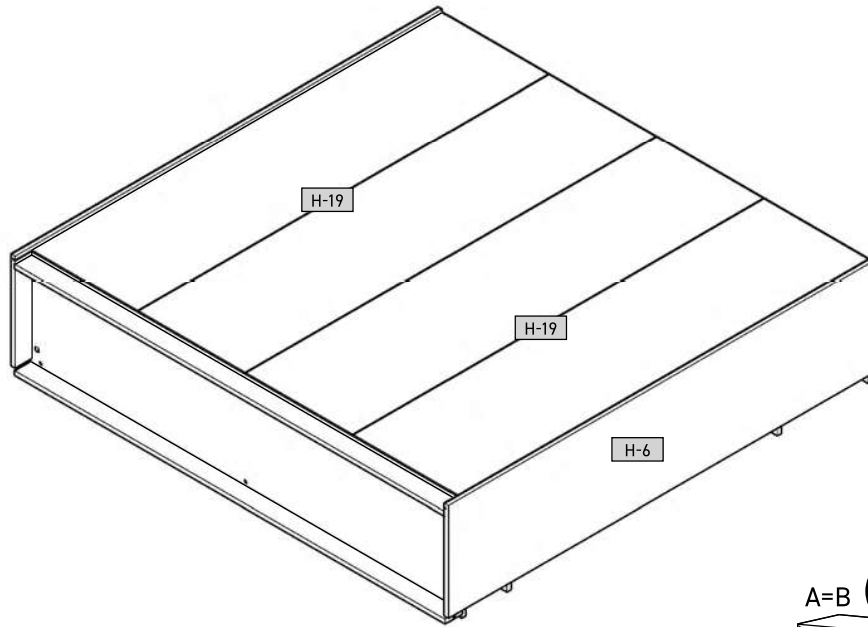

12

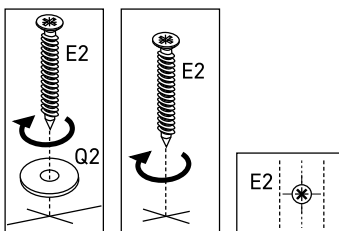
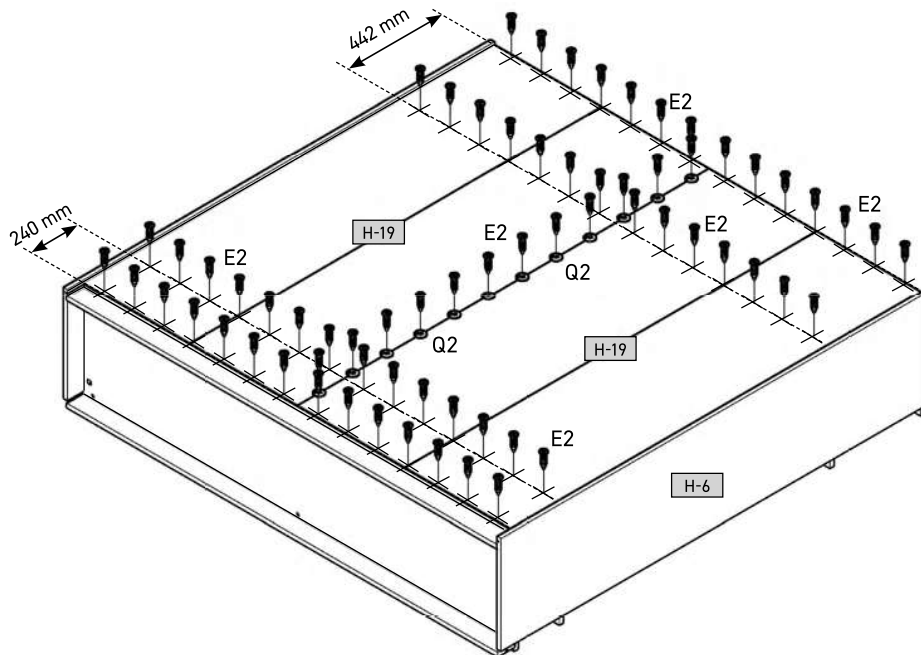
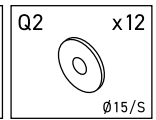
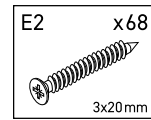
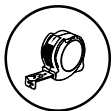



13

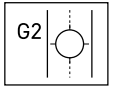
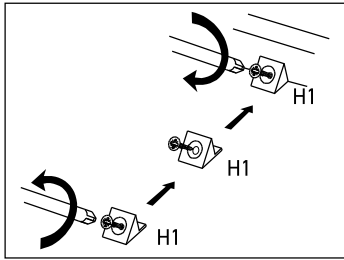
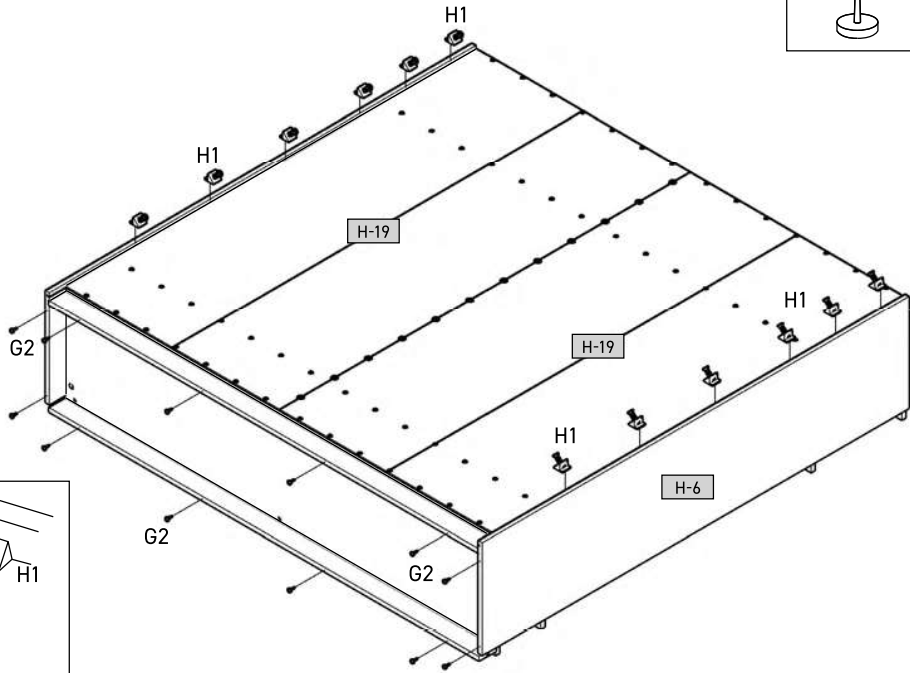
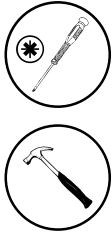
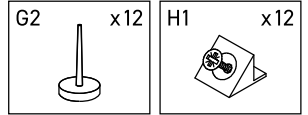

14

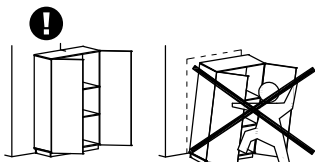
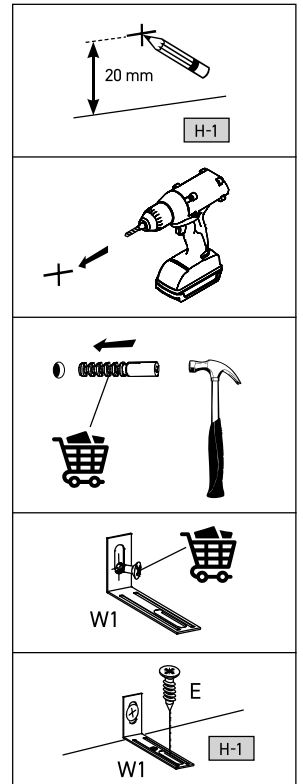
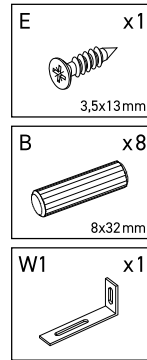
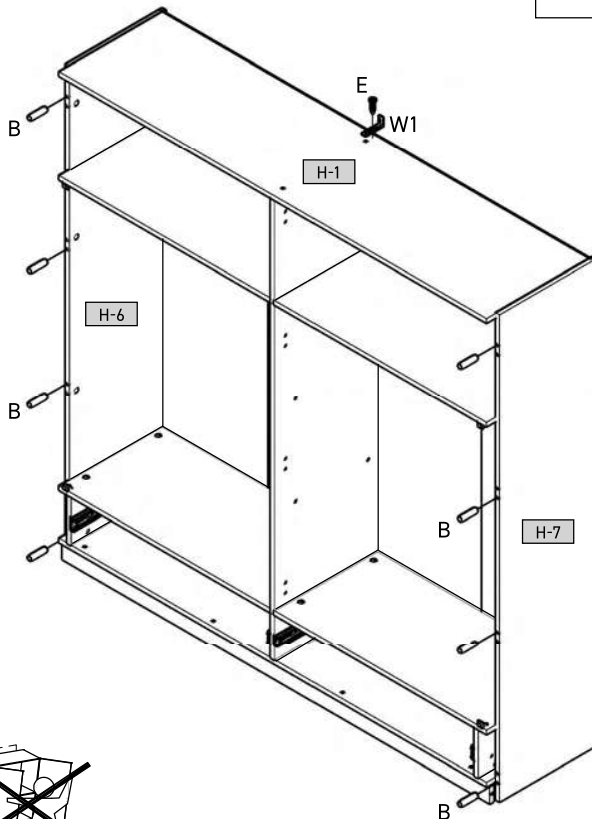
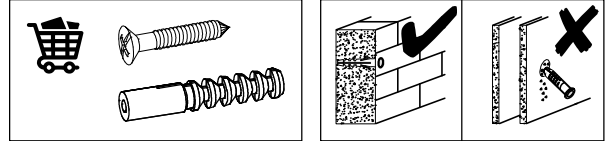
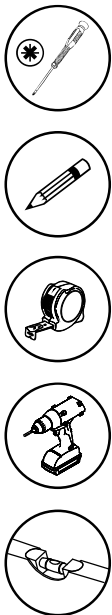



15

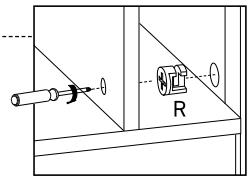
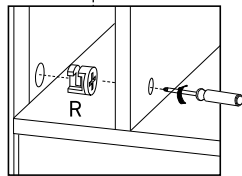
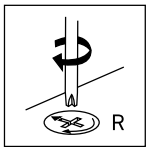
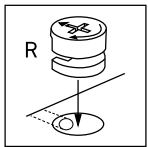
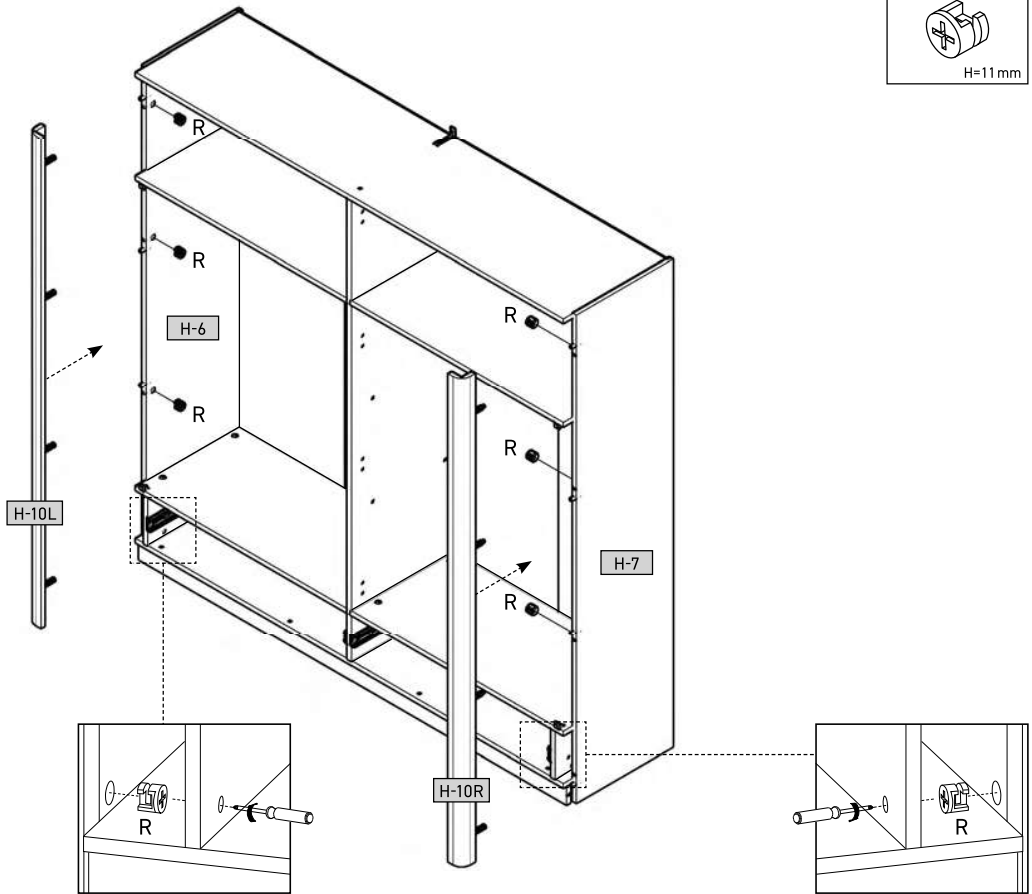
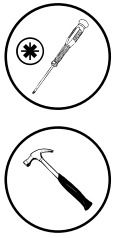
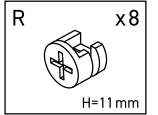

16

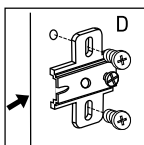
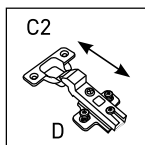
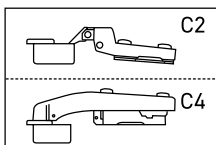
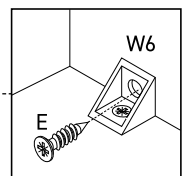
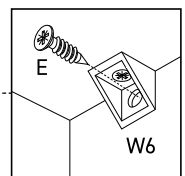
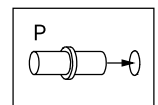
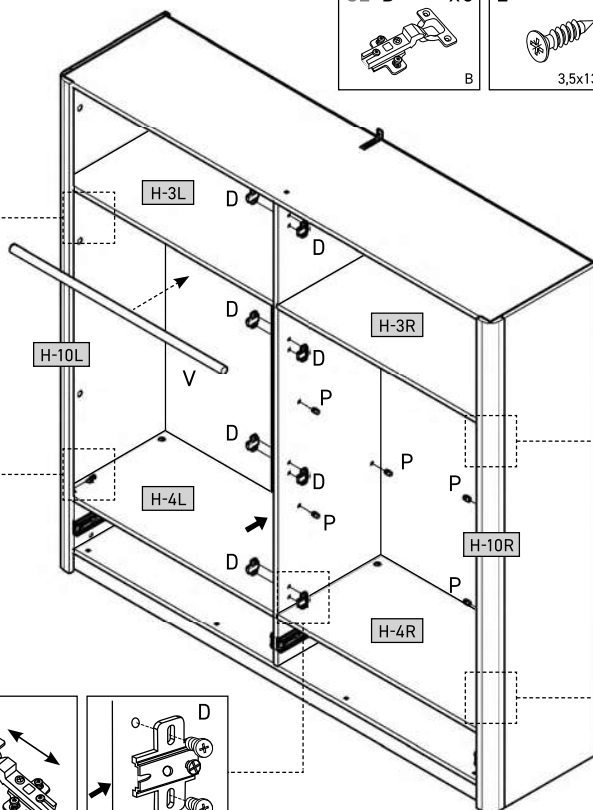
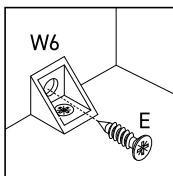
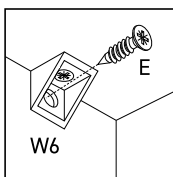
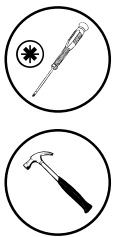
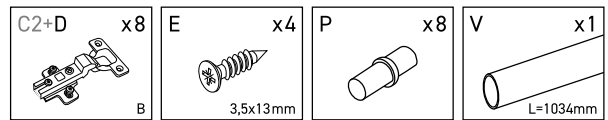



17

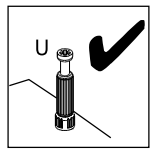
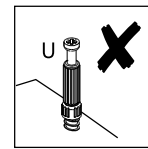
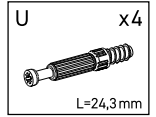
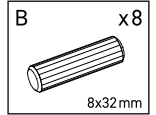
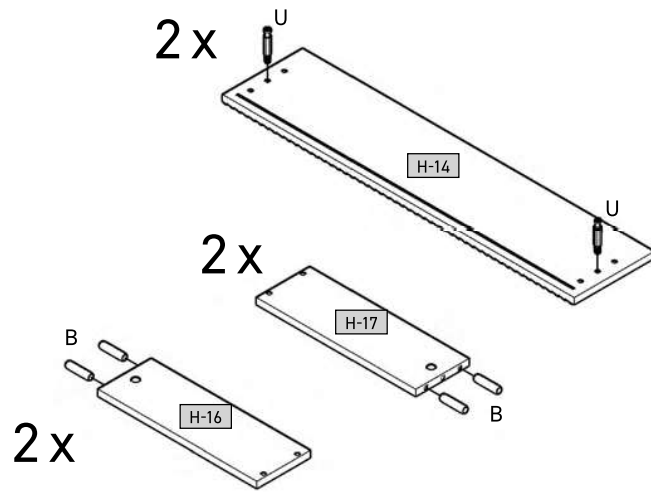

18

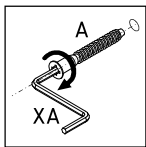
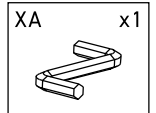
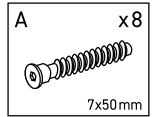
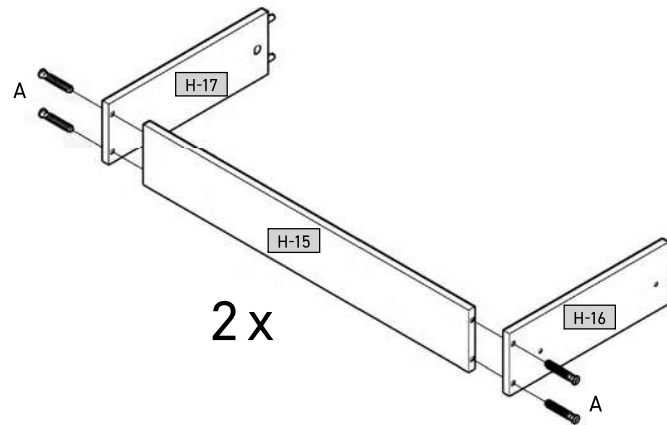

19

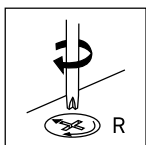
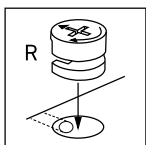
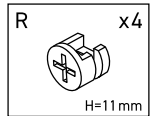
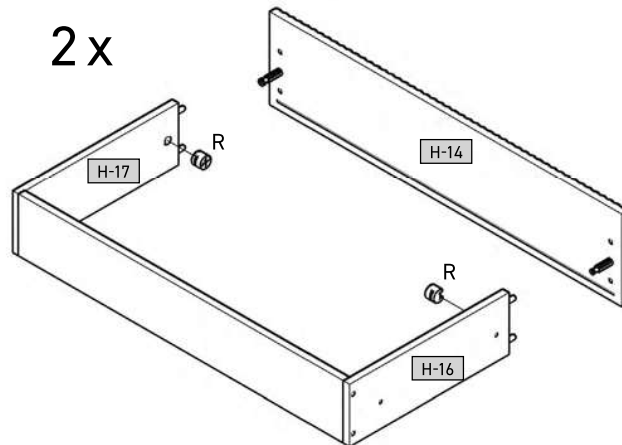



20

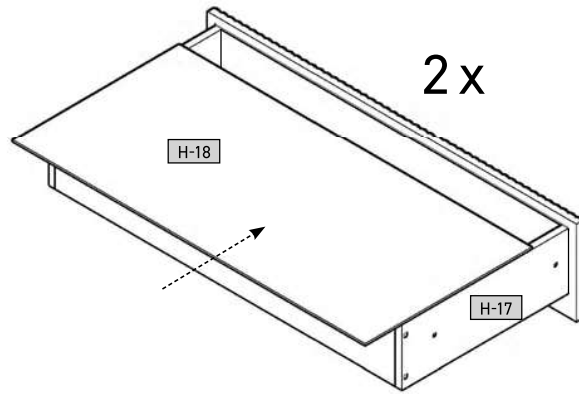

21

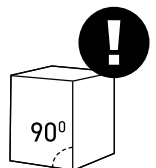
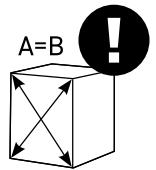
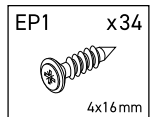
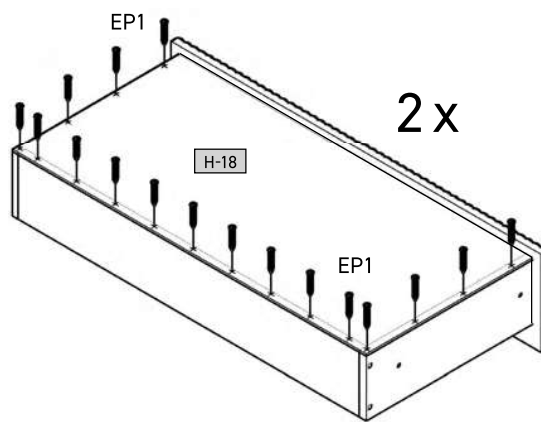
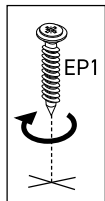
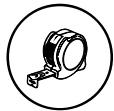

22

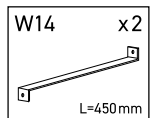
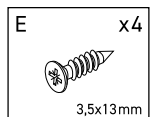
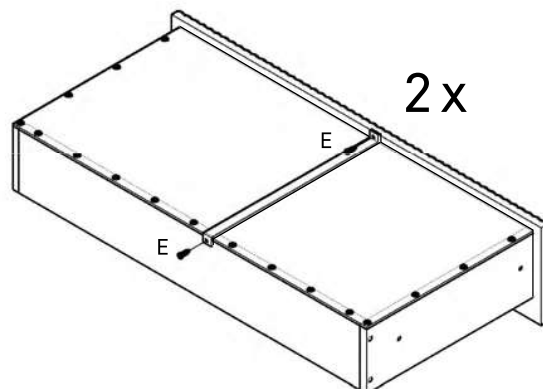
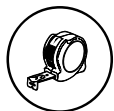



23

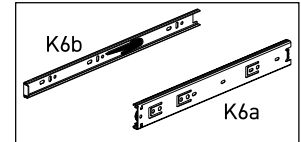
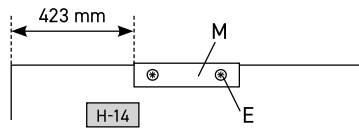
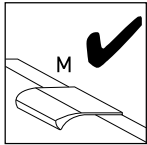
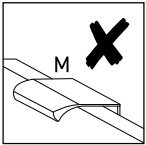
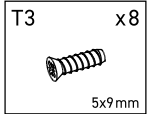
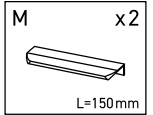
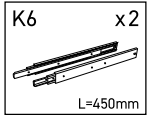
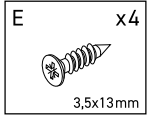
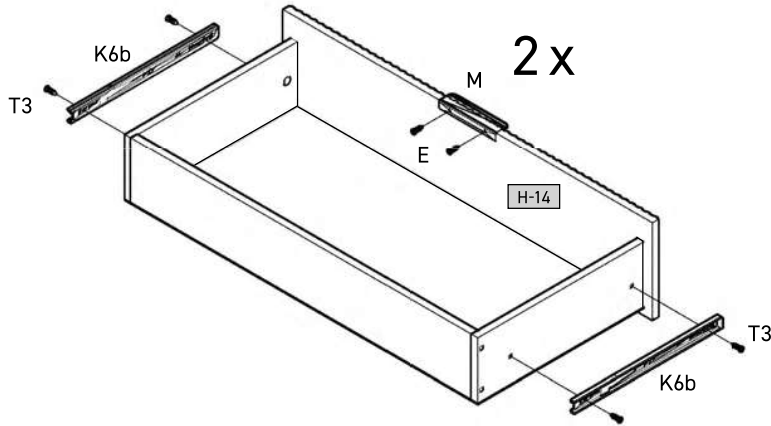

24

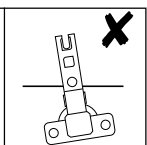
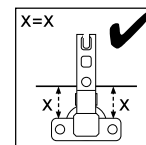
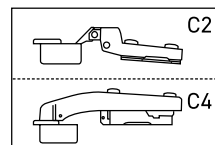
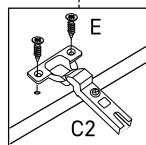
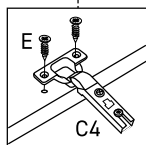
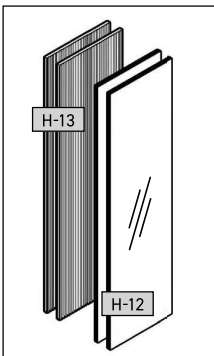
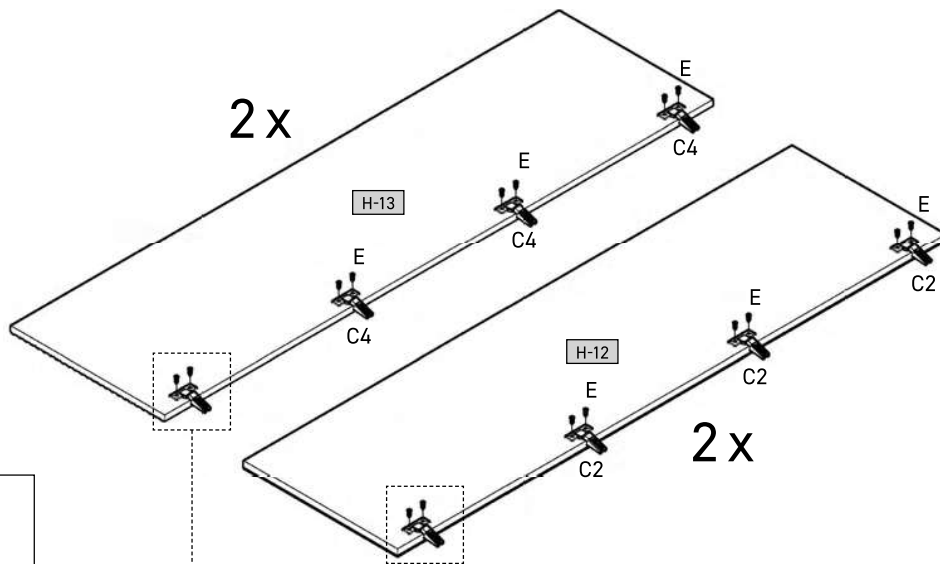
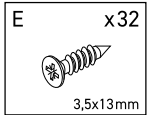
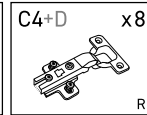
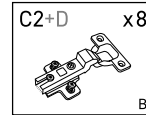



25

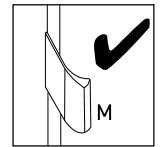
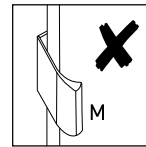
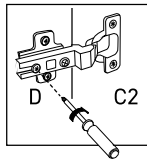
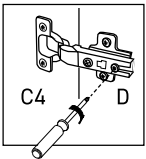
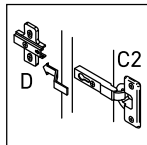
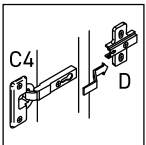
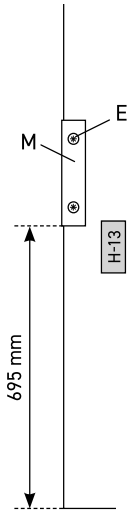
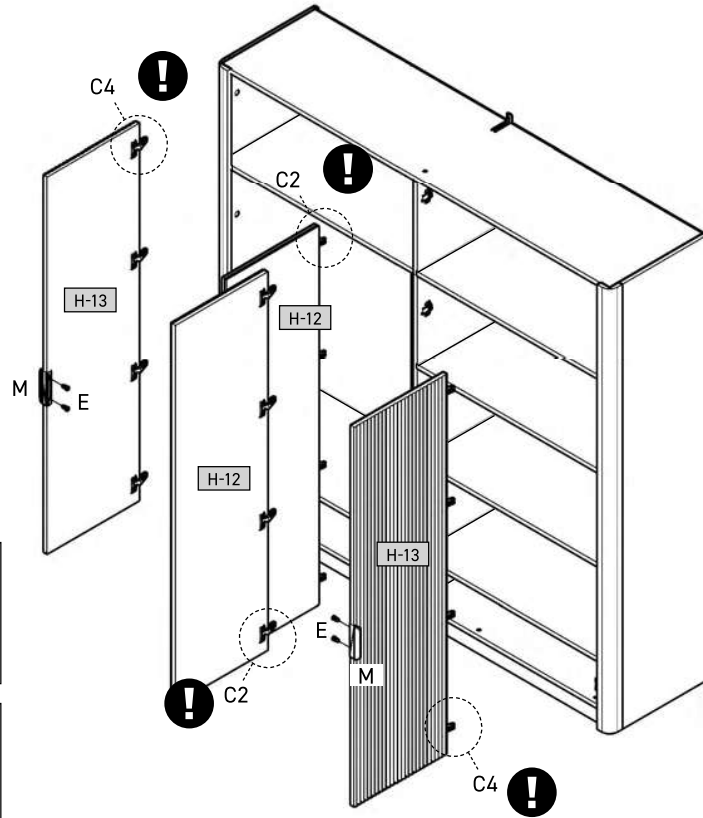
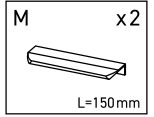
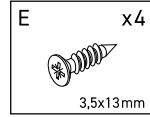

26

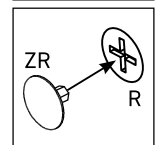
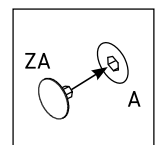
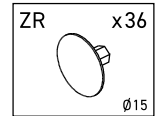
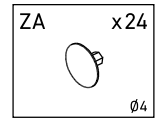
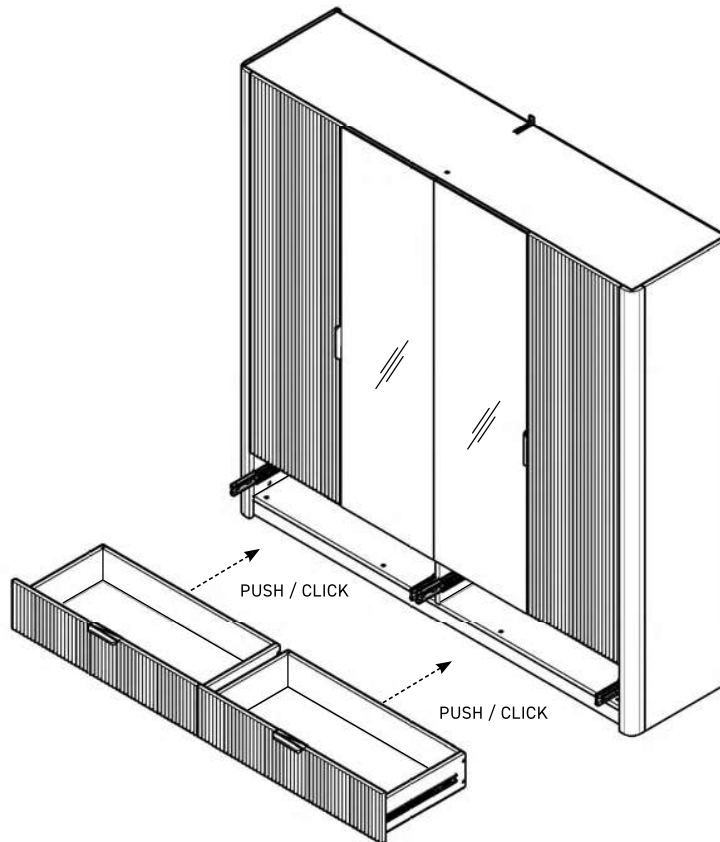



27

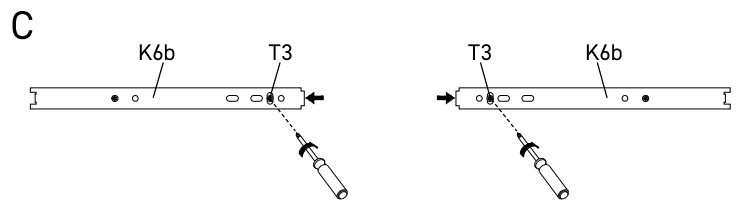
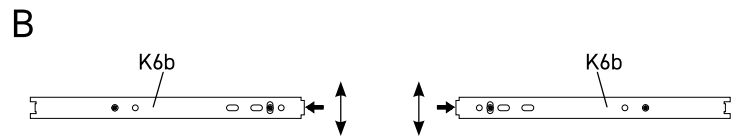
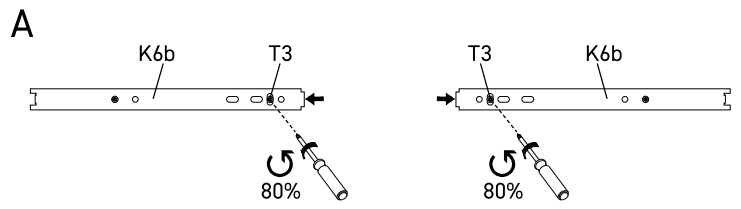
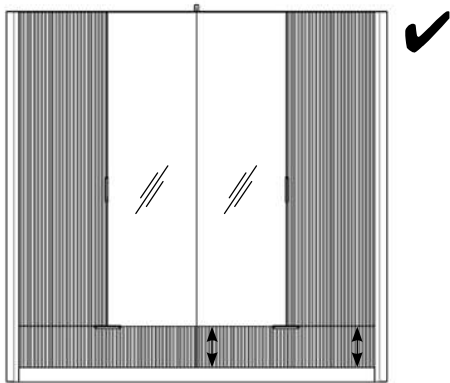
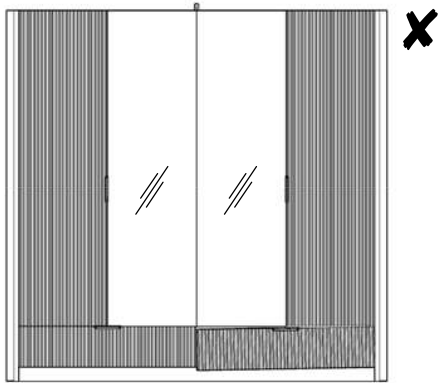

28

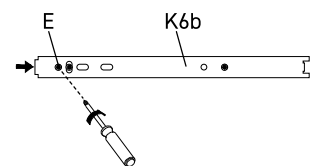
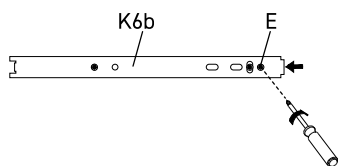
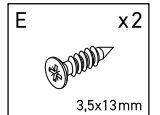
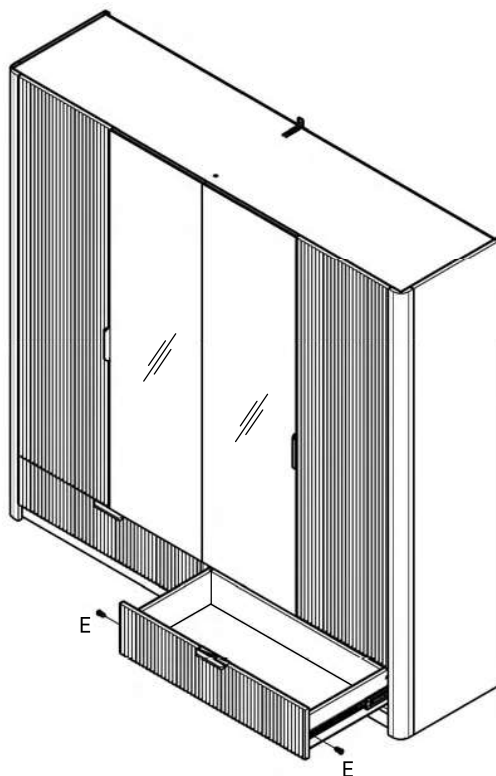



29

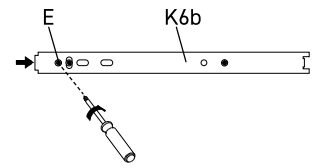
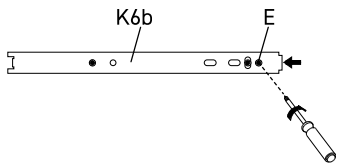
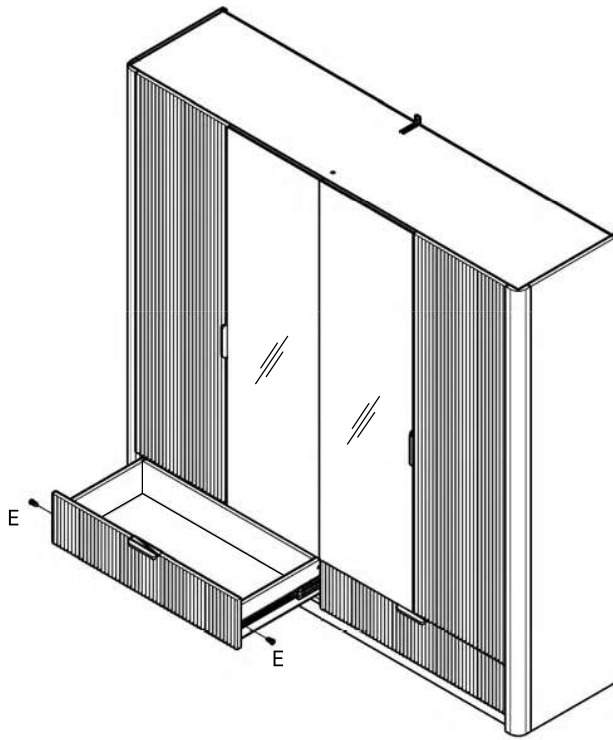
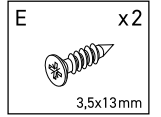

30

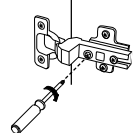
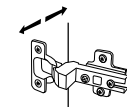
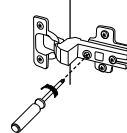
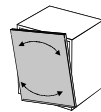
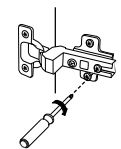
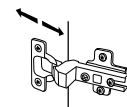
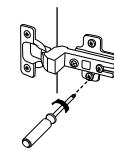
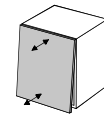
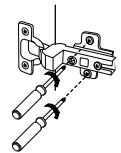
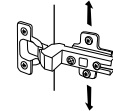
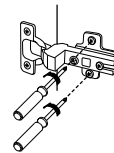
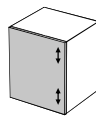
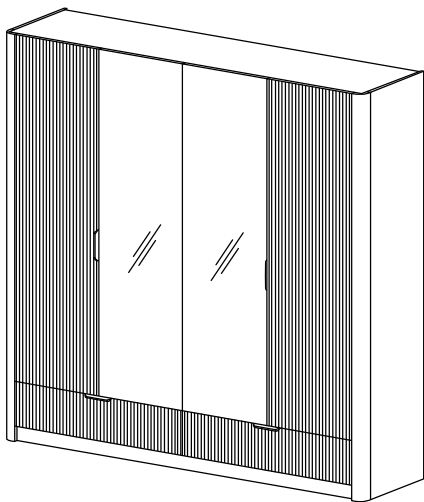

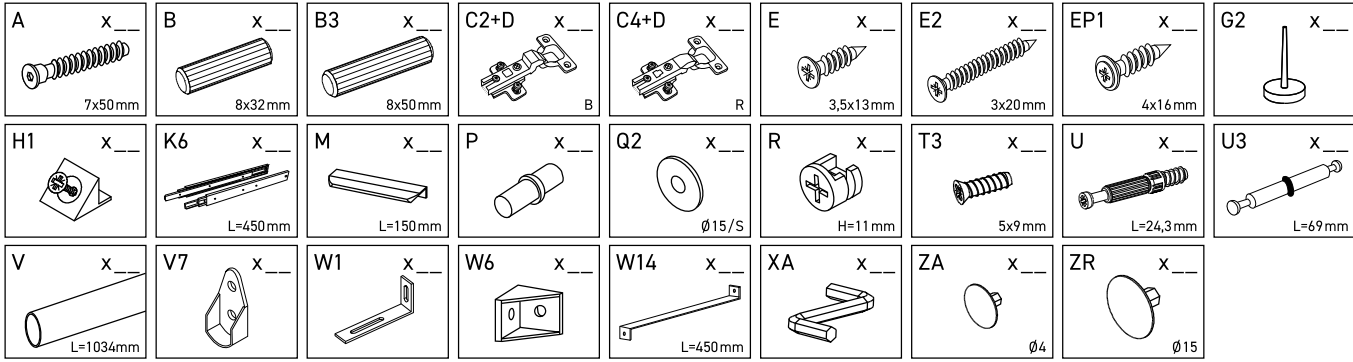

H-1	2098	505	16	x 1	2/5
H-2	2098	505	16	x 1	2/5
H-3L	1041	505	16	x 1	3/5
H-3R	1041	505	16	x 1	3/5
H-4L	1041	505	16	x 1	3/5
H-4R	1041	505	16	x 1	3/5
H-5	1041	490	16	x 2	3/5
H-6	2080	480	16	x 1	1/5
H-7	2080	480	16	x 1	1/5
H-8	1968	505	16	x 1	1/5
H-9L	218	505	16	x 1	1/5
H-9R	218	505	16	x 1	1/5
H-10L	2080	65	65	x 1	1/5
H-10R	2080	65	65	x 1	1/5
H-11	2098	80	16	x 2	2/5
H-12	496	1770	16	x 2	4/5
H-13	496	1770	18	x 2	5/5
H-14	996	226	18	x 2	2/5
H-15	928	150	16	x 2	2/5
H-16	450	150	16	x 2	1/5
H-17	450	150	16	x 2	1/5
H-18	958	456	3	x 2	1/5
H-19	1056	1997	3	x 2	2/5

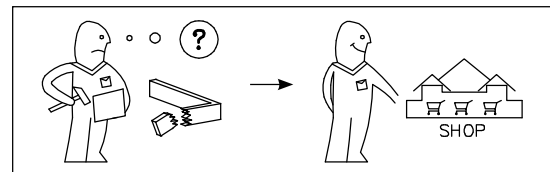
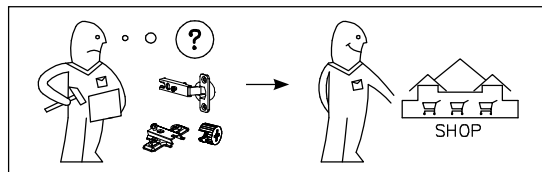
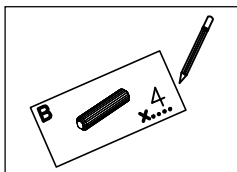
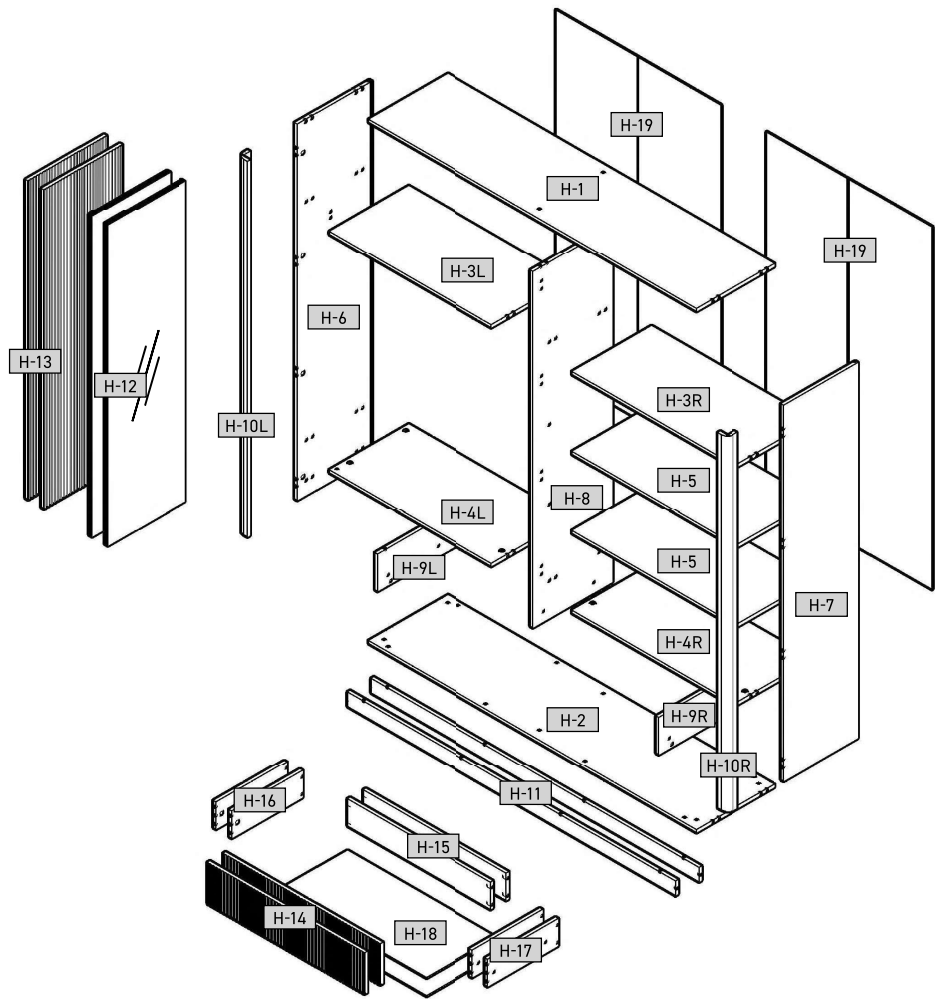

DE	Möbel aus Naturholz und Plattenwerkstoffen
PL	Mebel z drewna naturalnego oraz płyt drewnopochodnych
NL	Meubelen van natuurhout en plaatmateriaal
GB	Furniture made of natural wood and panel materials
IT	Mobili in legno naturale e materiali pannellati
FR	Meuble en bois naturel et plaque en dérivé du bois
PT	Móveis feitos de madeira natural e tábuas semelhantes a madeira

DE	PL	NL
<p>Liebe Kundin, lieber Kunde, vielen Dank für Ihre Bestellung! Gleichgültig, ob Sie ein aus Naturholz gefertigtes Möbelstück gekauft haben, eine Hochglanzfront oder eine matte Kunststofffront – jedes Möbelstück hat seine ganz speziellen Eigenschaften. Auch Holzverschleißfahigkeit und -struktur, wie zum Beispiel kleinere Äste bei Naturholzlösungen, sind Teil der individuellen Ausstrahlung jedes einzelnen Möbelstücks.</p> <p>Da Möbel aus Naturholz ständigen Klima- und Feuchtigkeitsschwankungen ausgesetzt sind, können vereinzelt Veränderungen in der Oberfläche auftreten wie z.B. Haarrisse oder Farbveränderungen. Generell nimmt im Laufe der Zeit die Helligkeit ab und die Farbsättigung zu – das Holz dunkelt nach. Die genannten Veränderungen sind bei einem Naturholzmöbel wie Holz ein normaler Prozess.</p> <p>Dieses Büchlein soll Ihnen ein paar Tipps zur Pflege Ihres Möbelstücks geben, damit Sie lange Freude daran haben können.</p> <p>Grundsätzlich gilt:</p> <ul style="list-style-type: none"> • Keine heißen Gegenstände auf die Möbel stellen. • Keine Kerzen direkt auf die Möbel stellen. • Verschlissene Flüssigkeiten sofort aufwischen. • In regelmäßigen Abständen einen festzugesetzten Schrauber und Beschlägen kontrollieren. • Der typische, aromatische Holzgeruch ist bei Naturholzmöbeln immer ein Qualitätsbeweis. • Hello Stellen an den Ästen entstehen durch einen natürlichen Harzaustritt und können mit einem trockenen, fusselfreien Tuch abgeleitet werden. • Auch von anderen Holz-, Lack-, Leder- oder Polstermaterialien ist ein schwacher Eigengeruch am Anfang unvermeidbar. Diese Gerüche verschwinden nach einiger Zeit von allein. Wenn Sie dies einschleifen wollen, lüften Sie in der Anfangszeit häufiger und/oder waschen Sie die Möbel leicht feucht mit Wasser ab, dies mit ein wenig Essig versetzt ist. • Bewahren Sie diese Hinweise gut auf. <p>Pflegehinweise für Möbel aus Plattenwerkstoffen Verwenden Sie zur Pflege Ihres Möbels aus Plattenwerkstoffen am besten ein weiches, nicht fusselfühendes Tuch oder ein Lederluch. Waschen Sie die Oberflächen leicht feucht ab.</p> <p>Grundsätzlich gilt: Verwenden Sie bitte auf keinen Fall folgende Reinigungsmittel:</p> <ul style="list-style-type: none"> • Microfasertücher oder Schmutzradierer. Diese erfüllen häufig keine Schleifpartikel, die zu einem Zerkleineren der Oberflächen führen können. • starke chemische Substanzen sowie scheuernde Putz- oder Lösungsmittel. Diese können die Oberflächen ebenfalls beschädigen. • Scheuerpulver, Stahnlwolle oder Topfkratzer. Sie zerstören die Oberfläche so stark, dass eine Aufarbeitung nicht mehr möglich ist. • Staubsauger, Düsen und Bürsten können die Oberflächen zerkratzen. • Dampfreiniger. Durch den hohen Druck und die Hitze, mit denen der Wasserdampf auf die Oberflächen trifft, können diese beschädigt werden oder sich sogar vom Untergrund ablösen. 	<p>Droga Kliento, Drogi Kliento, Dziękujemy za zamówienie! Niezależnie od tego, czy zakupiony przez Państwa mebel został wykonany z drewna litego, czy też posiada on front wykonany z płyty o wysoki połysku, lub też z płyty pokrytej matowym tworzywem sztucznym – każdy taki mebel ma swoje specjalne właściwości. Również wiązalność i struktura drewna – jak np. niewielkie słoje w meblach z drewna naturalnego – nadają meblom indywidualny charakter. Ponieważ meble z drewna naturalnego są nieustannie wystawione na działanie wilgoci i czynników atmosferycznych, mogą na ich powierzchni sporadycznie pojawiać się zmiany jak np. odbarwienia czy rysy, z bieżeniem czasu może zmienić się nasycenie koloru i drewno może ściemnieć. Wspomniane zmiany zachodzące w wyglądzie produktów wykonanych z surowców naturalnych są zupełnie normalne. Niniejsza instrukcja zawiera cenne wskazówki dotyczące pielęgnacji mebli, aby jak najdłużej mogli Państwo cieszyć się z ich nieograniczonego wyglądu.</p> <p>Podstawowe zasady:</p> <ul style="list-style-type: none"> • Nie stawiać na meblach gorących przedmiotów. • Nie stawiać świeczek bezpośrednio na meblach. • W przypadku rozlania wody natychmiastą wytrzeć. • Sprzątać w regularnych odstępach czasu, czy stłuky są dołgopcone, a okucia dobrze przysmożowane. • Charakterystyczny, aromatyczny zapach drewna występujący w przypadku mebli wykonanych z drewna naturalnego jest oznaką wysokiej jakości produktu. • Jazne miejsca na słojach powstają z powodu występowania żywicy – można je wypolować suchą, nie pozostawiając śladów szmatki. • W przypadku materiałów wykonanych z innego rodzaju drewna lub skory, produktów lakierowanych lub z obiciami, na początku również występuje charakterystyczny zapach „nowości”. <p>Zapach ten zmika po pewnym czasie użytkowania produktu. Jeśli chcieliby Państwo pozyczyć się tego zapachu szybciej, zalecamy wietrzyć często pomieszczenia i/lub przetrzeć meble suchą, jednolite złożoną w wodzie z niewielką ilością octu. • Prosimy zachować niniejsze wskazówki w bezpiecznym miejscu. <p>Wskazówki dotyczące pielęgnacji ługowanych/belejowanycy mebli z drewna naturalnego Poweższe wskazowane meble zostały zabezpieczone czystym biologicznym olejem. Aby zachować naturalny połysk powierzchni, zalecamy za pewien czas naderać ją olejem do pielęgnacji mebli. Po zabezpieczeniu powierzchni olejem zalecamy wytrzeć ją nie pozostawiając śladów szmatki. Szczotka do użytku powinna wyschnąć, następnie można ją wyrzucić.</p> <p>Wskazówki dotyczące pielęgnacji mebli z surowego/belejowanycy drewna naturalnego Poweższe meble najlepiej jest czyścić włgłątką ściereczką.</p> <p>Uwaga: Nie używać żrzących środków czyszczących ani rozpuszczalników.</p> <p>Wskazówki dotyczące pielęgnacji mebli z płyt drewnopochodnych Do pielęgnacji mebli najlepiej używać miękkiej, nie pozostawiającej śladów szmatki. Powierzchnię należy przetrzeć lekko złożoną szmatką.</p> <p>Podstawowe zasady: Nigdy nie należy stosować paliącychy środków czyszczących:</p> <ul style="list-style-type: none"> • ściereczka z mikrofibry ani papier do usuwania brudu. Często zawierają drobinki ściernie, które mogą porysować powierzchnię; • ostrych substancji chemicznych np. środków sżrzących lub rozpuszczalników. Mogą one zniszczyć powierzchnię; • proszkow czyszczących, waty stalowej ani ostrych myjek. Mogą one nie tylko uszkodzić powierzchnię; • odkurzaczy. Szczotka odkurzacza może porównać powierzchnię; • myjk parowych. Wysokie ciśnienie i wógot mogą uszkodzić powierzchnię oraz spowodować rozłojenie materiału. </p>	<p>Beste klant, Hartelijk dank voor uw bestelling! Het maakt niet uit of u een meubelstuk van natuurhout, een hoogglanzende voorkant of een matte plastic voorkant hebt gekocht – elk meubelstuk heeft zijn heel bijzondere eigenschappen. Ook de staat on structuur van het hout zoals kleinere takken bij natuurhout meubelen maken deel uit van de individuele look van elk afzonderlijk meubelstuk. Omdat meubelen van natuurhout zijn vótoegesat aan permanente klimaats- en vochtigheidsomveranderingen, kunnen er af en toe wijzigingen optreden van de bovenlaag zoals haarscheurjes of vloerwanderingen. In het algemeen neemt na verloop van tijd de helderheid af en de kleurverginging toeneemt – het hout wordt donkerder.</p> <p>De genoemde wijzigingen vormen bij een natuurlijk grondstof zoals hout een normaal proces.</p> <p>Dit boekje moet u een paar tips geven over het onderhoud van uw meubelstuk, zodat u er langere tijd plezier aan kunt beleven.</p> <p>In principe geldt:</p> <ul style="list-style-type: none"> • Plaats geen hete voorwerpen op de meubelen. • Veeg gemorst vloeistoffen direct af. • Controleer met regelmatige intervallen het slijtage niveau van schroeven en beslag. • De typische, aromatische houtgeur is steeds een kwaliteitsbewijs bij natuurhout meubelen. • Helttere plaatsen aan de takken ontstaan door een natuurlijk uitroden van hars en kunnen worden weggepoist met een droge, fusselfreie doek. • Ook van andere houten, lak-, leder- of gestoffeerde materialen is een zwakke eigen reuk bij het begin niet te vermijden. Deze geuren verdwijnen na enige tijd vanzelf. Als u wilt dat het sneller gaat, ventilt u in het begin vaker en/of veeg de meubelen krities vochtig af met water, dat een beetje is aangelengd met azijn. • Bewaar deze instructies goed. <p>Orderhandleidinges voor meubelen van plaatmateriaal Gebruik voor de reiniging van uw meubel van plaatmateriaal het best een zachte, niet pluizige doek of een leeren doek. Veeg de oppervlakken ietwat vochtig af.</p> <p>In principe geldt: Gebruik zeker niet volgende reinigings- en oplosmiddelen:</p> <ul style="list-style-type: none"> • microvezelkloeken of vulgommen. Deze bevatten vaak fine slijpdeeltjes die kunnen leiden tot krassen op de oppervlakken; • scherpe chemische substanties zoals scheurende poets- of oplosmiddelen. <p>Deze kunnen de oppervlakken eveneens beschadigen.</p> <ul style="list-style-type: none"> • schuurpapier, staalwol of pannensponzen. Ze vernietigen het oppervlak zo erg dat een reparatie niet meer mogelijk is; • stofzuiger. Mondstukken en borstels kunnen krassen op de oppervlakken veroorzaken; • stoomreiniger. Door de hoge druk en de hitte, waarmee de stoom op de bovenlagen komt, kunnen deze worden beschadigd of zelfs loskomen van de ondergrond.

DE	PL	NL
<p>Ihre Produktentwicklung</p>	<p>Dział Rozwoju Produktu.</p>	<p>De productontwikkelingsafdeling</p>

GB

Dear customer,
Thank you for your order!
No matter if you bought a piece of furniture made from natural wood, a high-gloss front or a plastic front – every piece of furniture has unique characteristics. Even the texture and structure of wood, such as small knots in natural wood furniture, are part of the individual charm of each piece of furniture. Since natural wood furniture are permanently exposed to climate and humidity fluctuations, changes to the surface may occur (e.g. hair cracks or changes in colour) in some cases. In general, brightness decreases and colour saturation increases in the course of time – the wood darkens.

The changes mentioned above are normal for natural raw materials such as wood. This booklet provides some care tips for your piece of furniture so that you can enjoy it for a long time.

The following applies in general:

- Don't place any hot objects on the furniture.
- Don't place candles directly on the furniture.
- Immediately wipe off any spilled liquids and oils.
- Regularly tighte if the screws and fittings are tight.
- The typical, aromatic wooden odour is always a proof of quality for natural wood furniture.
- The natural emission of resin may produce bright spots on the knots which can be polished with a dry, lintfree cloth.
- Initially, a slight intrinsic odour is unavoidable for other wooden, paint, leather or upholstery materials too. These odours automatically disappear after a while. If you want to speed up this process, ventilate more often at the beginning and/or wipe out the furniture with a slightly damp doth which was soaked in water mixed with a small amount of vinegar.
- Keep these notes in a safe place.

Care notes for furniture made of panel materials
We recommend using a soft, lint-free doth or a shammy for conditioning your piece of furniture made of panel materials. Wipe off the surfaces with a slightly damp doth or shammy.

The following applies in general:
Please don't use the following detergents or cleaning agents at all:

- **microfibre cloths** or **dirt erasers**. They often contain fine abrasive particles which can cause scratches on the surfaces;
- **aggressive chemical substances** as well as **abrasive cleaning agents** or **solvents**. They may damage the surfaces too;
- **souring powder, steel wool** or **scouring pads**. They destroy the surface so badly that reconditioning is impossible;
- **vacuum cleaners**. The nozzles and brushes can cause scratches on the surfaces;
- **steam cleaners**. The surfaces may be damaged or separated from the ground due to the high pressure and heat of the water vapour.

Your product development team

IT

Gentili clienti,
sentiti ringraziamenti per il vostro ordine!
A prescindere che abbiate scelto un mobile realizzato in legno naturale, un fronte lucido o un fronte di materiale plastico opaco – ogni esemplare la sue particolarità. Anche le caratteristiche e la struttura del legno, quali ad esempio rami minori nei mobili di legno naturale, sono parte del fascino individuale di ogni singolo mobile.

Dato che i mobili in legno naturale sono esposti al continuo variare del clima e dell'umidità, è probabile che in superficie insorgano mutamenti quali crepe capillari o cambiamenti di colore. Generalmente con passar del tempo diminuisce la chiarezza e aumenta la saturazione del colore – il legno si scurisce.

I citati mutamenti sono un normale processo dei materiali naturali, quali appunto il legno.

Il presente libretto intende darvi alcuni suggerimenti sulla cura del vostro mobile, affinché vi procuri lunghe soddisfazioni.

Stanzialmente vale:

- Non poggiare oggetti roventi sui mobili.
- Non poggiare candele a diretto contatto dei mobili.
- Asciugare subito i liquidi sversati.
- Ad intervalli periodici controllare se vi e cerniere sono salde.
- Il caratteristico odore fragrante è sempre una prova di qualità dei mobili in legno naturale.
- Le macchie chiare sui rami si formano per via della naturale fuoriuscita di resina, e sono levigabili con un panno asciutto che non lascia peli.
- Anche trattandosi di altri materiali (legno, di vernice, pelle o imbottiti), all'inizio è inevitabile un leggero odore caratteristico. Dopo qualche tempo però, questi odori svaniscono da sé. Potete aiutare a farli volatilizzare in minor tempo cambiando più spesso aria all'inizio etc. passando sui mobili un panno umido d'acqua con qualche goccia d'aceto.
- Conservare bene le presenti istruzioni.

Istruzioni sulla cura dei mobili in materiali pannellati
Per la cura dei mobili in materiali pannellati si consiglia di usare un panno morbido, che non lascia peli, o un panno di pelle. Passare il panno leggermente umido sulle superfici.

Stanzialmente vale: In nessun caso utilizzare i seguenti detergenti e prodotti per la pulizia:

- **panni in microfibra** o **spugne di tampono**. Questi prodotti contengono spesso fini particelle abrasive, che possono provocare sgraffiature sui mobili;
- **forti sostanze chimiche nonché detergenti o solventi abrasivi**. Anche questi prodotti possono aggredire le superfici;
- **polvere abrasiva, paglietta d'acciaio** o **spugne abrasive**. Rovinerebbero la superficie in modo tale che non sarebbe più possibile ripararle;
- **aspirapolvere**. Bocchette e spazzole possono sgraffiare le superfici;
- **pulitrice a vapore**. Per via dell'elevata pressione e calore con cui il vapore colpisce le superficie, esse rischiano di deteriorarsi o addirittura staccarsi dalla sottostruttura.

Area Sviluppo prodotti

FR

Chère cliente,
cher client,
Merci pour votre commande!
Peu importe que vous ayez acheté un meuble fabriqué en bois naturel, un face haut brillance ou une face en plastique mat – chaque meuble a ses particularités. Même les propriétés et la structure du bois, comme par exemple les petits nœuds sur des meubles en bois naturel, font partie de l'aspect de chaque meuble.

Comme le meuble en bois naturel est soumis aux variations permanentes du climat et de l'humidité, il se peut que quelques modifications surviennent sur la surface, comme par exemple de fines fissures ou des décolorations. En règle générale, au cours du temps, la clarté du bois diminue et son intensité de coloration augmente – le bois devient foncé. Les modifications susmentionnées sont un processus normal des matières naturelles comme le bois.

Ce petit livret vous donne quelques astuces sur l'entretien de votre meuble pour que vous puissiez en profiter longtemps.

En règle générale:

- Ne pas poser d'objets chauds sur le meuble.
- Ne pas poser de bougies directement sur le meuble.
- Essuyer immédiatement les liquides renversés.
- À intervalles réguliers, contrôler que les vis et les ferrures sont bien serrées.
- L'odeur aromatique typique du bois est toujours une preuve de qualité des meubles en bois naturel.
- Les entailles claires sur les nœuds se produisent par une sécrétion naturelle de résine qui s'illimine avec un chiffon sec non pelucheux.
- Les autres matériaux comme le bois, la peinture, le cuir ou le rembourrage peuvent initialement avoir un léger odeur. Ces odeurs disparaissent d'elles-mêmes avec le temps. Si vous souhaitez qu'elles disparaissent plus vite, au début, aérer plus souvent et passer sur les meubles avec un chiffon légèrement imbibé d'eau mélangée avec un peu de vinaigre.

Conservez bien cette notice.

Consignes de soin pour les meubles avec des plaques en dérivé du bois
Pour l'entretien de votre meuble en plaques en dérivé du bois, utilisez de préférence un chiffon doux non pelucheux ou une peau de chamois. Essayez la surface légèrement humide.

En règle générale: Utilisez r'utiiser en aucun cas les détergents suivants:

- **Chiffons à microfibras** ou **gomme à saleté**. Ils contiennent souvent de fine particules abrasives qui peuvent rayer les surfaces;
- **substances chimiques agressives** ainsi que **des détergents abrasifs**. Ceux-ci peuvent également endommager les surfaces;
- **Consignes de soin pour les meubles avec des plaques en dérivé du bois**
Pour l'entretien de votre meuble en plaques en dérivé du bois, utilisez de préférence un chiffon doux non pelucheux ou une peau de chamois. Essayez la surface légèrement humide.
- **En règle générale:** Utilisez r'utiiser en aucun cas les détergents suivants:
- **Chiffons à microfibras** ou **gomme à saleté**. Ils contiennent souvent de fine particules abrasives qui peuvent rayer les surfaces;
- **substances chimiques agressives** ainsi que **des détergents abrasifs**. Ceux-ci peuvent également endommager les surfaces;
- **pourde à recurer, pelle de fer** ou **sponge grattant**. Elles détruisent la surface si profondément qu'il n'est plus possible de la retoucher;
- **aspirateur**. Les buses et les brosses peuvent rayer la surface;
- **nettoyeur à vapeur**. De fait de la haute pression et de la chaleur avec lesquelles la vapeur d'eau sort sur la surface, elles peuvent être endommagées et même décoller la base.

Votre service de développement de produits



Uwaga - Upozornění - Achtung - Attention - Caution - Figyelem
 Attenzione - Opgelet - Atenție - Upozornenie - Dikkat

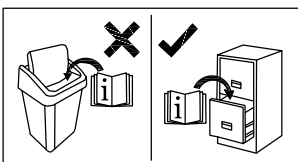
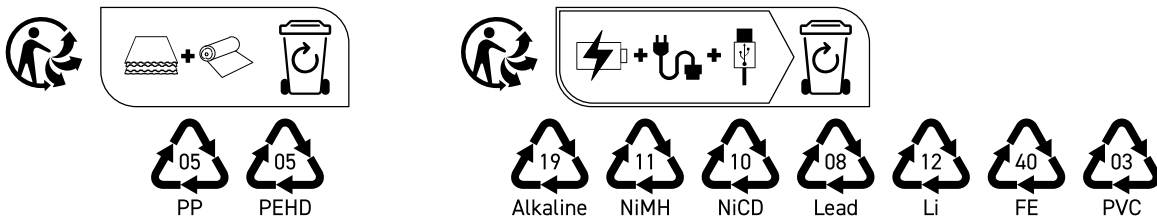
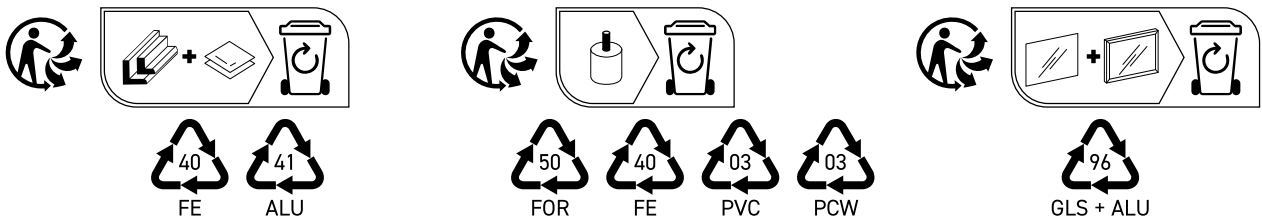
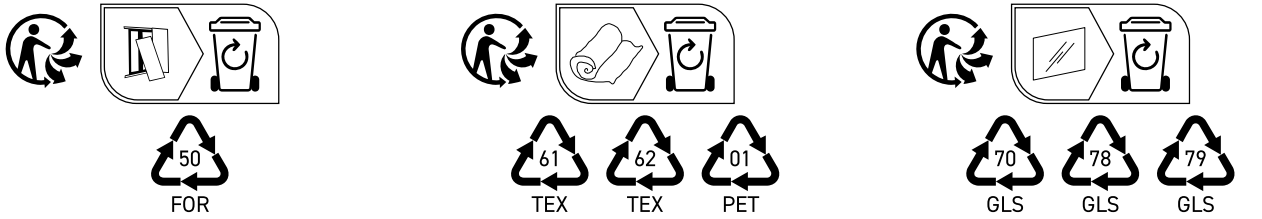
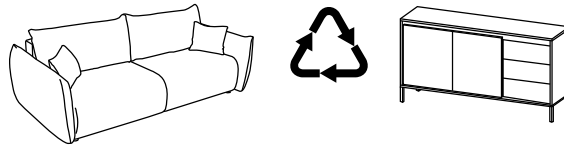
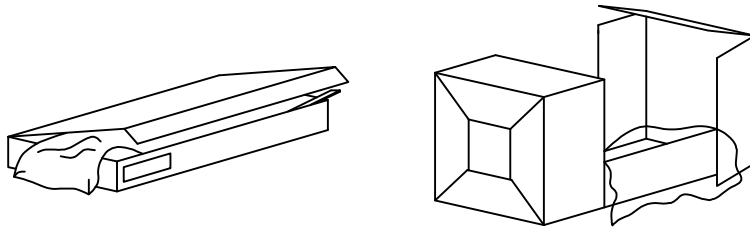



Uwaga - Upozornění - Achtung - Attention - Caution - Figyelem
 Attenzione - Opgelet - Atenție - Upozornenie - Dikkat

