

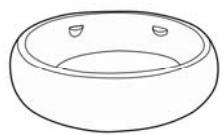



USE & CARE GUIDE

**☰ TABLE TOP MOTHER & CHILD
DECORATIVE FOUNTAIN
W/ LED**

PARTS

A	1x	B	1x	C	1x	D	1bag	E	1x	F	1x
											
PART A		PART B		BALL		STONE		LED LIGHT		PUMP	

TOOLS REQUIRED FOR ASSEMBLY

• No tools required

ASSEMBLY INSTRUCTION

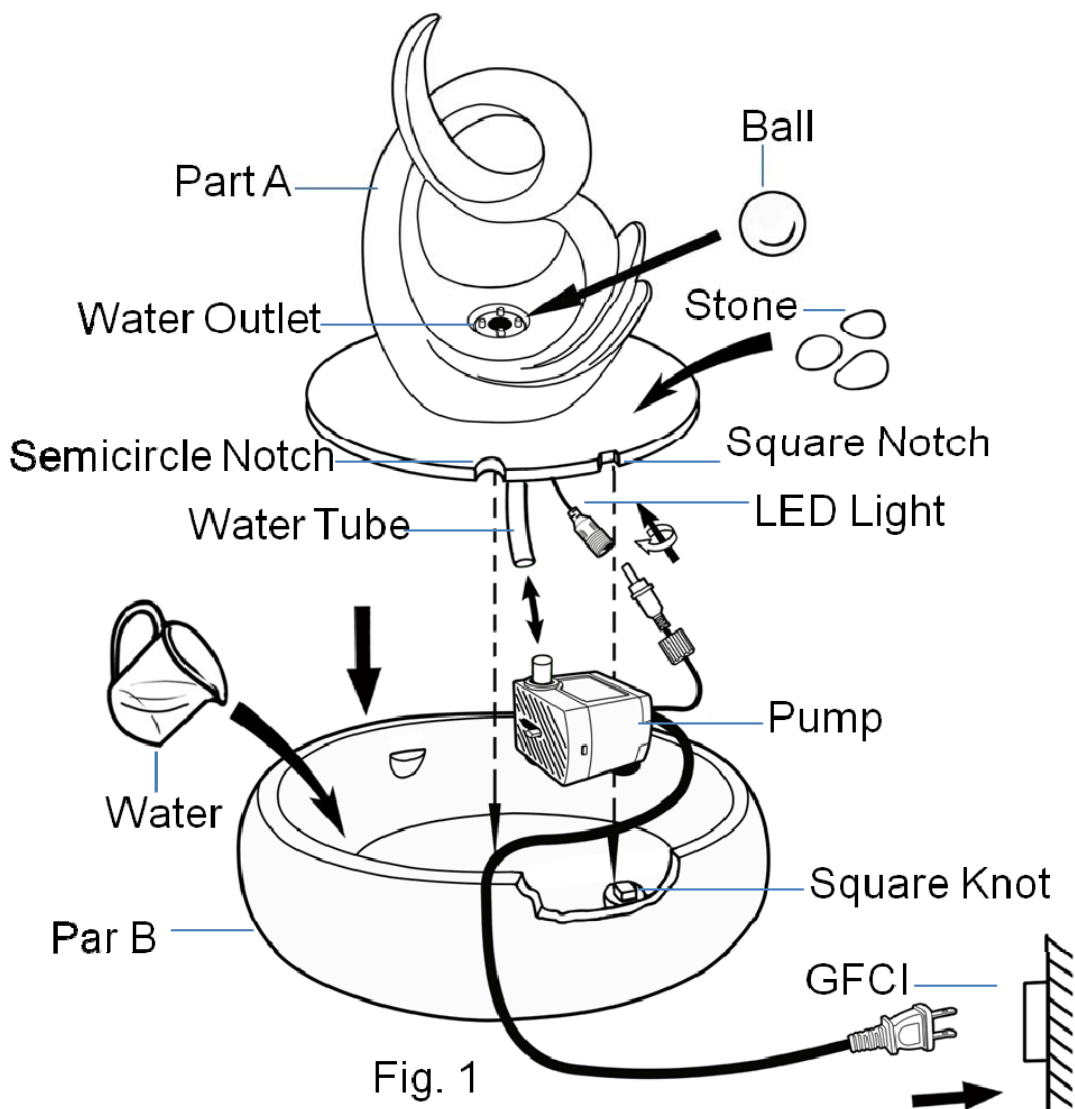

Fig. 2

NOTE: The diagrams shown are for illustrative purposes only and are not to scale

ASSEMBLY INSTRUCTIONS

1. Unpack the contents of the box and check to make sure that all items are accounted for and in good condition.
2. Select a flat, level surface for the assembly and final location of your fountain.
3. Position the part A over the part B and align the square notch which is on the bottom of part A with the square knot which is on the part B. Connect the light power cable and ensure the LED group lights touch the bottom of the part A. Insert the pump outlet that is on the top of the pump into the water tube which is located under the part B. Place the pump upright into the fountain body and lead the pump power cord through out the semicircle notch which is on the bottom side of part A. Place the part A into the part B. Place the ball on the water outlet of part A. Place the stone onto the part A surface. (Fig.1)
4. Add clean water into the Part B. The water level should be approximately 1 in. / 25 mm lower than the edge of the basin. Connect the pump to a GFCI outlet and the product will begin to function as intended. (Fig. 1)
5. If the pump runs with low or high water circulation Check and adjust the regulator dial or slide on the front of the pump. Adjust the dial/slide towards (+) to increase water flow or towards (-) to decrease water flow. (Fig. 2)
6. To eliminate the possibility of water damage around your fountain, check for leaks and excessive splashing after the initial setup of your fountain. It is highly recommended that this fountain be placed in an area where it cannot be damaged that might cause damaged with the fountain .
7. Do not leave your fountain running for extended periods of time when no one is present to observe the performance.
8. Check the area around your fountain on a regular basis to ensure that there is no leakage.

IMPORTANT SAFETY INSTRUCTIONS

PUMP

CAUTIONS:

1. The pump has been evaluated for use with water only.
2. Risk of electric shock.
3. Do not remove cord and strain relief. Do not connect conduit to pump.
4. Do not use the pump in water exceeding 86°F / 30°C.
5. Do not use the pump in flammable liquids.
6. Do not use the pump for industrial purposes.
7. Do not use the pump in vehicles or on board ships or aircraft or swimming pools.
8. Do not use the pump in location where special conditions prevail, such as the presence of a corrosive or explosive atmosphere (dust, vapor or gas).
9. Do not let the pump run dry. Pump must be completely submerged for proper operation and cooling.
10. Do not lift the pump by its power cord.
11. Keep the plug dry. Do not expose the plug to water or steam.
12. Before connecting to the power source, make sure that the pump is assembled and completely submerged in water.
13. Always disconnect the pump from the power source before performing any maintenance on the pump, lights (if equipped), or fountain.
14. Do not exceed the voltage shown on the pump.
15. Check the water level regularly to ensure the pump is completely submerged during operation. The pump should be fully submerged during operation. Do not add water while operating the product. Always disconnect the pump from the power source before adding water.



WARNINGS:

1. Risk of electric shock. This pump is supplied with a grounding conductor and grounding-type attachment plug. To reduce the risk of electric shock, be certain that it is connected only to a properly grounded, grounding-type receptacle.
2. To reduce the risk of electric shock, use only on portable self-contained fountains no larger than 5 ft / 1.52 m in any dimension.
3. If equipped with a 3-prong, grounded type plug, do not remove the grounding pin from the plug on the power cord.

CARE AND MAINTENANCE

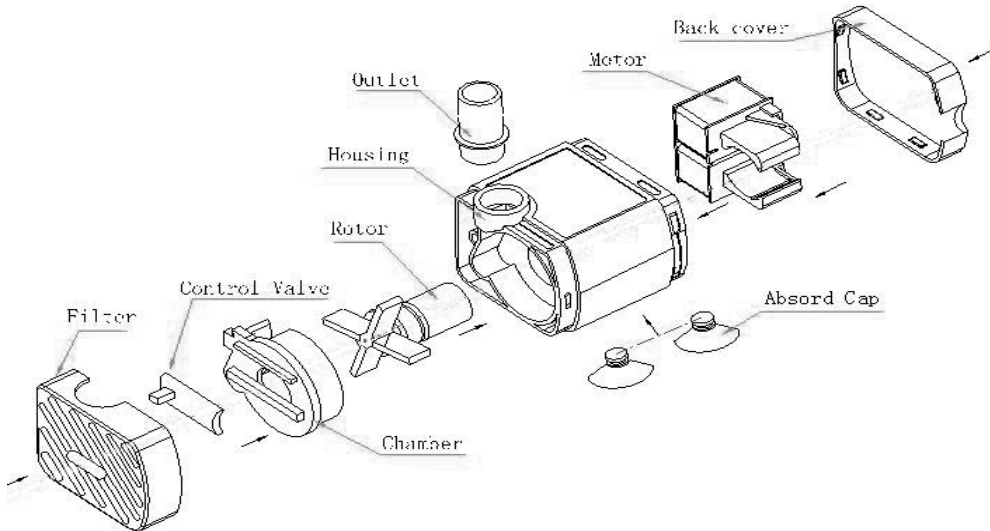

1. Distilled water is always recommended to fill your fountain. Distilled water is pure and should have no minerals or sediment in it. It will extend the life of the pump and the time between cleanings. If distilled water is not an option, use filtered water, as water directly from your tap will generally have minerals and chemicals that can build up and leave behind residue on your fountain.
2. Check the water level regularly to ensure the pump is completely submerged during operation. This is necessary to ensure proper cooling of the pump and prevent overheating. In summer months, or dry, hot climates, water evaporates very quickly, so it may be necessary to check the water level every day. The rate of water evaporation will also be greater with larger fountains, with more surface area, than smaller fountains.
3. Keep the fountain water and pump clean and clear of debris. If placed under a tree or near vegetation, you may need to scoop out leaves and other debris every other day. Water treatments that prevent algae growth and mineral deposits are available at your local home & garden stores. Do not use bleach as it may be harmful to pets and wildlife and may also damage the finish of the fountain.
4. Clean the fountain monthly to prevent mineral deposits and contamination which may clog the pump. Disconnect the pump from the power source and empty the water from the fountain. Avoid using any harsh chemicals, abrasives or rough scrubbing, as this could damage the finish on your fountain. The frequency of cleaning may vary depending on the location of your fountain.
5. Use a pre-filter on your pump if available to prevent it from clogging with leaves or other debris.
6. Regular cleaning of the pump will be necessary depending upon the environment in which it is operated. Clean the pump when it is visibly soiled or when a noticeable decrease in performance is detected. Failure to clean the pump will result in overheating of the pump.
7. Before cleaning, always disconnect the pump from the power source.
8. Disassemble the pump by removing the filter and regulator/impeller plate. Remove the impeller/rotor assembly by gently pulling on the impeller blades. Use a soft cloth or brush to clean the area inside of the pump housing. Clean the filter, gland and impeller in warm soapy water. Reassemble the pump and inspect for proper operation. Please see the diagram which matches your pump below:
9. Although it is not required, pumps generally last longer if left running continuously as it reduces the wear from starting and stopping. However, running the pump continuously will also use a little more electricity, and will require you to refill the fountain more frequently. If mosquitoes are a problem in your area, it is recommended to run the fountain as much as possible to prevent standing water, where mosquitoes breed. You may also add a few drops of anti-mosquito water treatment, available at your local home and garden store, to the fountain water.
10. Place the fountain in a location that will not be damaged should the area come in contact with liquids.
11. To eliminate water damage to floors and/or surrounding fountain areas, check for leaks and excessive splashing after initial installation and on a regular basis.
12. If your fountain develops a leak and a visible crack is detected, plastic epoxy or Clear Silicone II sealant may be used to seal it. If the fountain leaks without a visible crack, turn the pump off, fill the fountain and let the fountain sit for one week. If there is a crack, it will appear white. Remember to keep the water $\frac{3}{4}$ full as will evaporate over time. Seal the leak with plastic epoxy or Clear Silicone II sealant.
13. If the fountain is not in use for an extended period of time, disconnect the power and empty all the water from the fountain. Do not tip the fountain to empty the water. Use a siphon pump or a small bucket.
14. The fountain should not be operated in temperatures below 41° Fahrenheit / 5° Celsius to prevent frost damage. During winter months, before the temperature hits freezing, disconnect the power, drain your fountain and store it in a heated area. If the fountain is stored outdoors in freezing temperature, disconnect the power, empty all the water from the fountain, remove the pump and any lights if possible, make sure it is completely dry and cover it with a tarpaulin. Any water left in the fountain may freeze and expand causing the fountain to crack.
15. If your fountain is equipped with an independent light set, you can use an outlet timer to have the lights activate during night time hours. Please note, on some models the lights cannot be operated independently from the pump so the lights are on, when the pump is on.

TROUBLESHOOTING GUIDE

If the pump does not operate...

1. Check to make sure the pump is connected to a power source.
2. Check the water level to ensure the pump is completely submerged. Add water as needed. If the pump operates, but, there is no water flow...

1. Check the water level to ensure the pump is completely submerged. Add water as needed.
2. Check the supply tube for any kinks or folds and correct.

If the pump operates, but there is no water flow and the pump is fully submerged and the supply tubing has no kinks...

1. Disconnect the pump from the power source.
2. Disconnect the supply tube from the pump outlet.
3. Check for clogs or holes and clean the tubing inside and outside if necessary.
4. Check for clogs and clean the pump inlets and outlet if necessary.
5. Place the pump back into the water outlet side up and then re-connect the pump to the power source.
6. Once the water begins to flow from the pump, re-connect the supply tubing to the pump outlet.
7. Check for any air trapped in the water supply tube which may prevent the pump from working. If the pump runs with low or high water circulation...

1. Check and adjust the regulator dial or slide on the front of the pump. Adjust the dial/slide towards (+) to increase water flow or towards (-) to decrease water flow.

If the pump operates, but the water flow is uneven or non existent and the pump makes noise...

1. Check the impeller assembly for wear. Remove the front cover and regulator/impeller plate and remove the impeller assembly. Clean the impeller assembly and inspect for wear. If the rotor spins freely from the magnetic body, the impeller assembly is worn and needs to be replaced. Contact customer service for replacement parts.

If the pump starts to make noise...

1. Check the water level to ensure the pump is completely submerged. If the water level drops below the pump intake, it may suck in air and cause the noise or the pump to completely stop working.
2. Move the pump away from the sides of the basin or place a piece of foam or sponge underneath the pump to isolate any vibration which causes the noise.

If the water starts to foam...

1. Check the water level to ensure the pump is completely submerged. If the water level drops below the pump intake, it may suck in air and cause the pump to 'spit' and foam the water.
2. Add a few drops of anti-foaming water treatment, available at your local home and garden store, to the fountain water.

If the water flow is uneven...

1. Gently sweep across the water surface to achieve even water flow across the face of the fountain.
2. Check the top of the basin to ensure it is level. If not, shim the basin from the bottom until the top spillway is level or has achieved even water flow all around.

SAVE THESE INSTRUCTIONS! This manual contains important safety and operating instructions

Each product may have variations in texture, finish and appearance from one unit to the next. This enhances the beauty of the product and makes your product uniquely individual. Some products and finishes are intentionally weathered or worn in appearance for aesthetic design.

WARRANTY

LIMITED WARRANTY

This product is warranted to the user against missing parts, defective material and workmanship, under normal working conditions, for a period not to exceed the term noted on the chart below. This warranty period begins on the date of purchase by the original purchaser.

Main body	30 days on construction, materials, paint and finish
Pump	30 days

This warranty covers only properly installed and maintained units. Pump warranty is limited to applications pumping fresh water at temperatures between 41°F - 95°F (5°C - 35°C), with a PH range of 5 – 9.

Upon receipt of a defective item, the manufacturer will, at its sole option, repair, replace or refund, as appropriate, any defective parts free of charge and return it to you, postpaid. If it is appropriate to replace your product, the manufacturer will replace the product with the same product or a comparable product at the manufacturer's option.

GENERAL TERMS AND CONDITIONS

Proof of purchase is necessary to request a claim under this warranty. This warranty does not apply to appearance or accessory items. This warranty does not include damage due to improper packing, handling, or transportation. For products lost or damaged in transit, a claim should be filed with the carrier.

This warranty does not cover any costs associated with the installation and removal of products or parts subject to this warranty. This warranty shall not apply to acts of God, nor shall it apply to products which, have been subject to negligence, abuse, accident, misapplication, tampering, alteration or modification; nor due to improper installation, operation, maintenance, repair or storage; nor to other than normal application, use or service, including but not limited to, operational failures caused by corrosion, rust or other foreign materials in the system, or operation at pressures in excess of recommended maximums.

DISCLAIMER

Any oral statements made about the product by the seller, the manufacturer, the representatives, or any other parties do not constitute warranties, should not be relied upon by the user, and are not part of the contract for sale. The sellers and manufacturers only obligation, and buyers only remedy shall be for the manufacturer to either replace and /or repair at the manufacturers sole discretion, the product as described above. Neither seller nor the manufacturer shall be liable for any injury, loss or damages for lost profits, lost sales, injury to person or property, or any other incidental or consequential loss arising from any cause whatsoever, no matter whether based upon warranty, contract, negligence or other misuse, and the buyer and user agree that no other remedy shall be available to them. Before using, the buyer and user shall determine the suitability of the product for intended use, and assume all risk and liability whatsoever in connection therewith. The warranty and remedy described in this limited warranty is an exclusive warranty and remedy in lieu of any other warranty or remedy expressed or implied. All other warranties and remedies are hereby expressly excluded, including but not limited to any implied warranty of merchantability of fitness for any particular purpose.

OTHER LEGAL RIGHTS

This warranty gives the buyer and user specific legal rights, and buyer and user may also have other rights which vary from state to state. Some states do not allow exclusions or limitation of incidental or consequential damages, so the above limitations or exclusions may not apply to you.

THANK YOU

We appreciate the trust and confidence you have placed in our product through the purchase of this fountain. We strive to continually create quality products designed to enhance your home. Visit us online to see our full line of products available for your home improvement needs. Thank you for choosing our product.