

Assembly Instruction

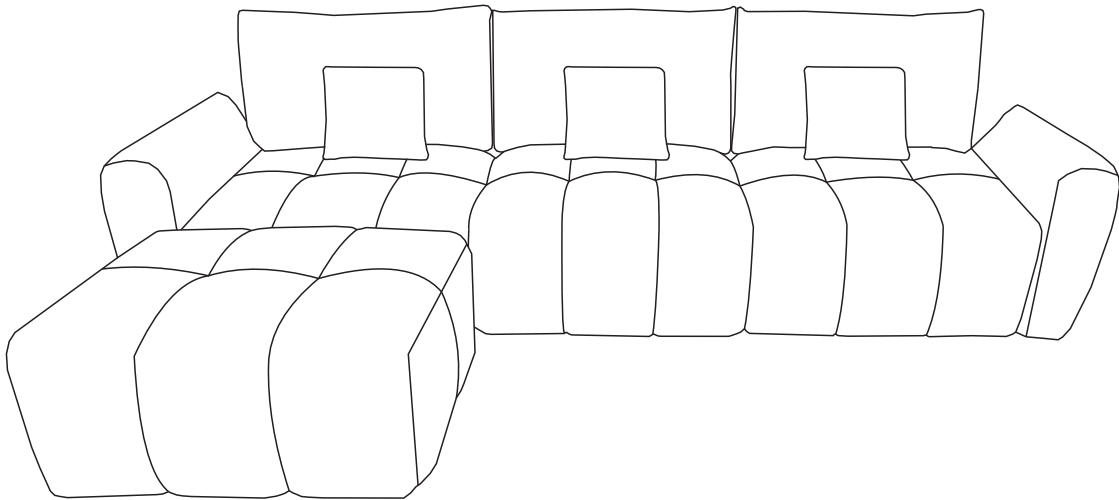

Thank you for choosing our product!

To ensure safe and satisfactory use, please read the following instructions carefully before assembly.

1. This sofa ships in three boxes. We recommend unpacking and assembling the sofa only after all three boxes (A,B,C) have been received.
2. The sofa cushions are vacuum-packed for convenient shipping. Please allow 2-3 days for them to fully expand to their original shape and for any wrinkles to disappear.
3. If any part is damaged or missing, there is no need to return the product. Simply contact us, and we will gladly provide and ship the replacement parts free of charge.

SHIP IN
4
BOXES

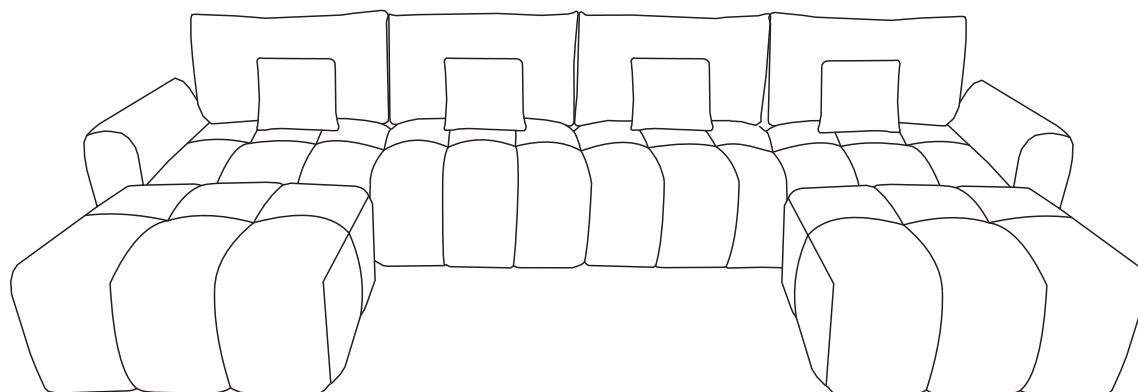









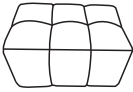
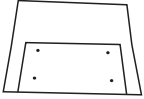

Thank you for choosing our product!

To ensure safe and satisfactory use, please read the following instructions carefully before assembly.









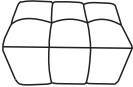
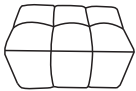
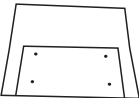

1. This sofa ships in four boxes. We recommend unpacking and assembling the sofa only after all four boxes (A,B,B,C) have been received.
2. The sofa cushions are vacuum-packed for convenient shipping. Please allow 2-3 days for them to fully expand to their original shape and for any wrinkles to disappear.
3. If any part is damaged or missing, there is no need to return the product. Simply contact us, and we will gladly provide and ship the replacement parts free of charge.

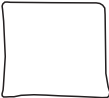
PART LIST & HARDWARE

Parts List BOX A

A Seat cushion  2PCS	G Backrest  2PCS	H Back cushion  2PCS	E Pillow  2PCS	M Connecting Iron  4PCS
Q L-shaped Iron  4PCS	K Leg  8PCS	N Washer  32PCS+1PC	O M8*35mm Bolt  24PCS+1PC	P M8*60mm Bolt  8PCS+1PC
R Allen Key  1PC				









Parts List BOX B

A Seat cushion  1PC	B Ottoman  1PC	G Backrest  1PC	H Back cushion  1PC	E Pillow  1PC
Q L-shaped Iron  2PCS	M Connecting Iron  2PCS	K Leg  8PCS	N Washer  20PCS+1PC	O M8*35mm Bolt  12PCS+1PC
P M8*60mm Bolt  8PCS+1PC	R Allen Key  1PC			

Note: Please retain all boxes until you are certain that your product isn't damaged and that you do not wish to return it. Disposal of boxes may prevent our ability to resolve your request.

PART LIST & HARDWARE

Parts List BOX C

C Left armrest  1PC	D Right armrest  1PC	Q L-shaped Iron  4PCS	K Leg  4PCS	N Washer  20PCS+1PC
O M8*35mm Bolt  16PCS+1PC	P M8*60mm Bolt  4PCS+1PC	R Allen Key  1PC		

Note: Please retain all boxes until you are certain that your product isn't damaged and that you do not wish to return it. Disposal of boxes may prevent our ability to resolve your request.

A+B+C

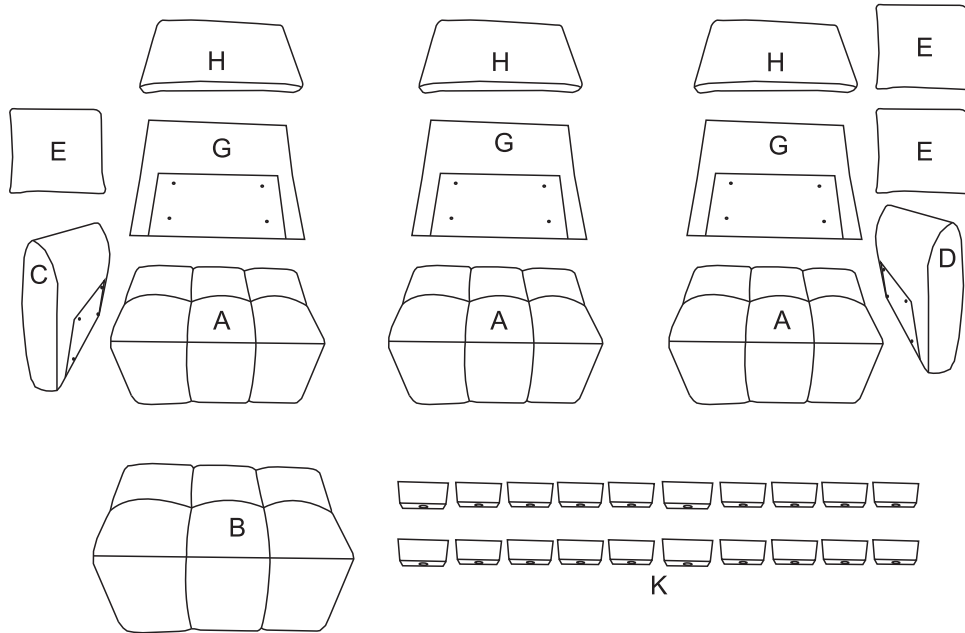

A+B+B+C

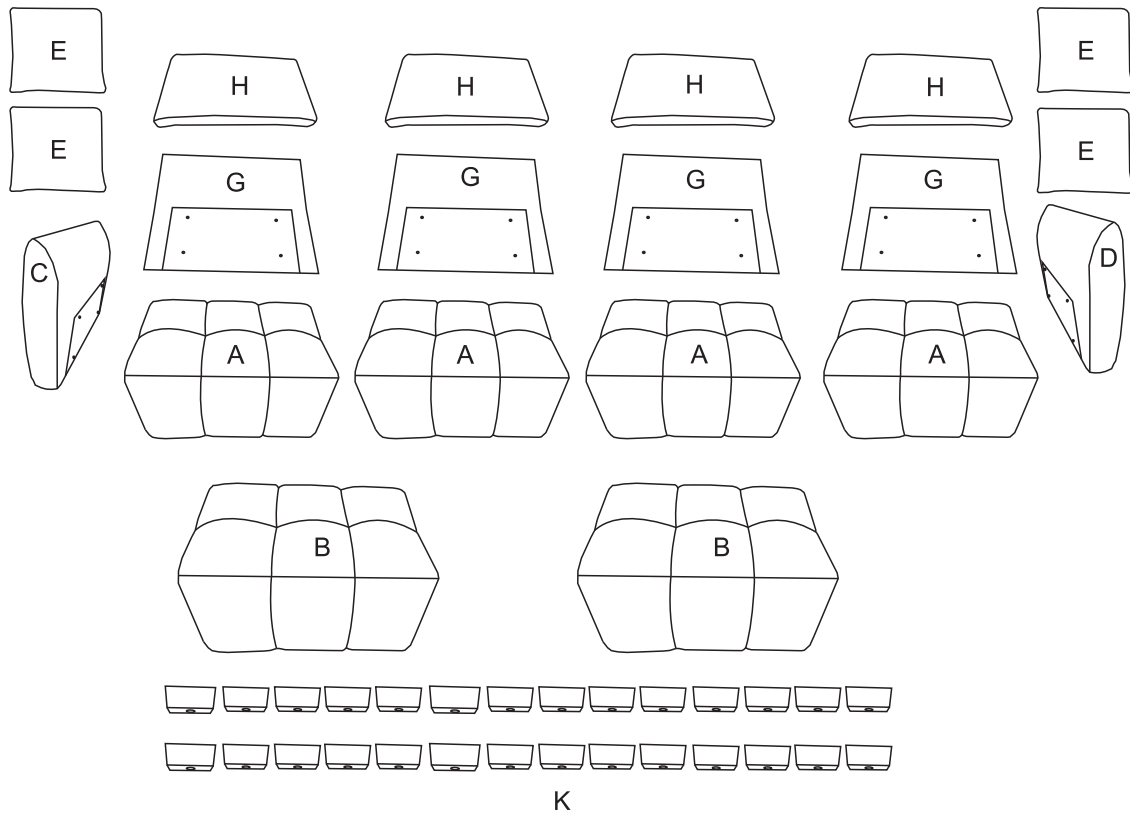

ASSEMBLY STEPS

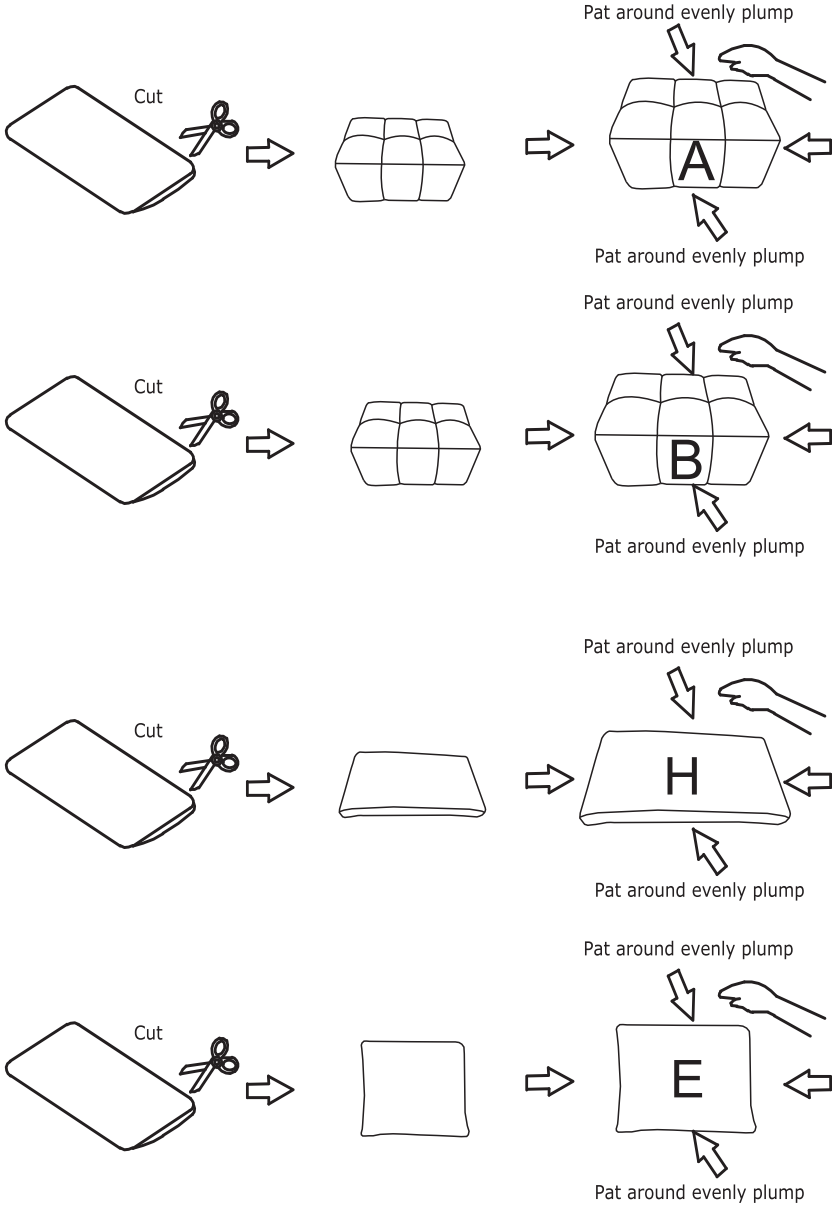

STEP 1

Use scissors to carefully open all vacuum-sealed cushions and pillows. Allow 48-72 hours for them to fully expand back to their original shape. To help them regain their shape faster, please try firmly and evenly pat around each cushion.



STEP 2

Align the sofa leg (K) with the marked attachment points on the 3 sofa base(A), 1 Ottoman(B), or armrest(C)(D) (as indicated in the diagram), place a washer (N) and tighten with a bolt (P) to ensure a secure installation.

N		20PCS
P		20PCS

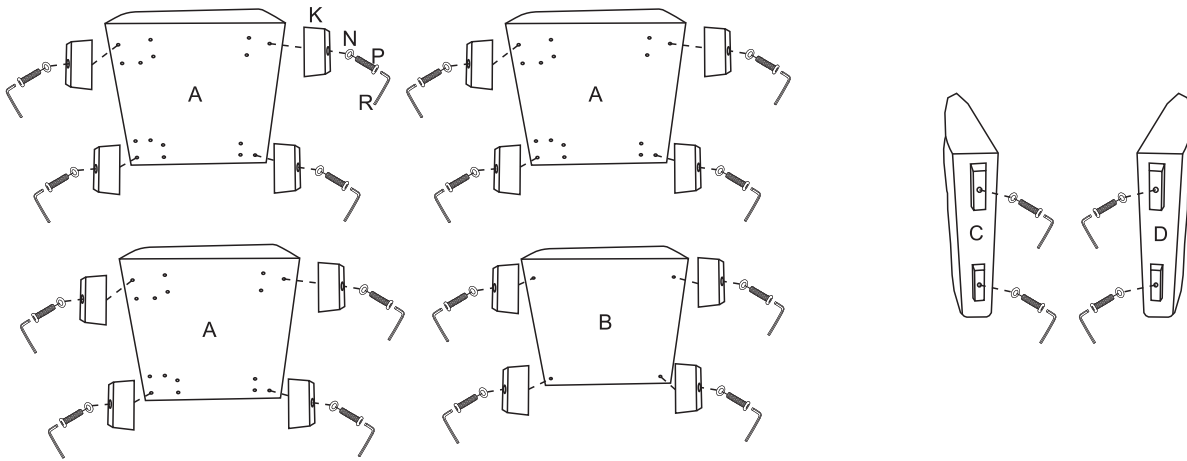

If you buy a four-seater two-seater footstool

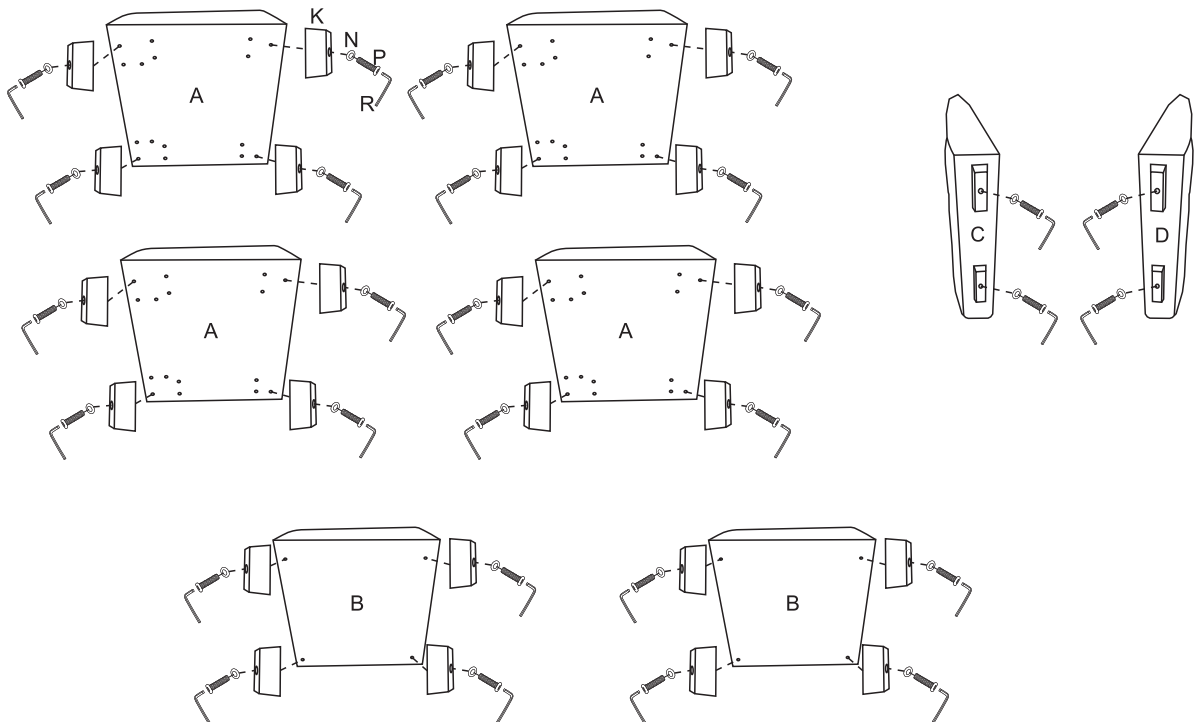

STEP 3

Align the L-shaped iron with the marked attachment points on the three backrests (G) or two armrests (C) and (D) (as shown in the diagram), place a washer (N) and tighten with a bolt (O) to ensure a secure installation.

N		20PCS
O		20PCS

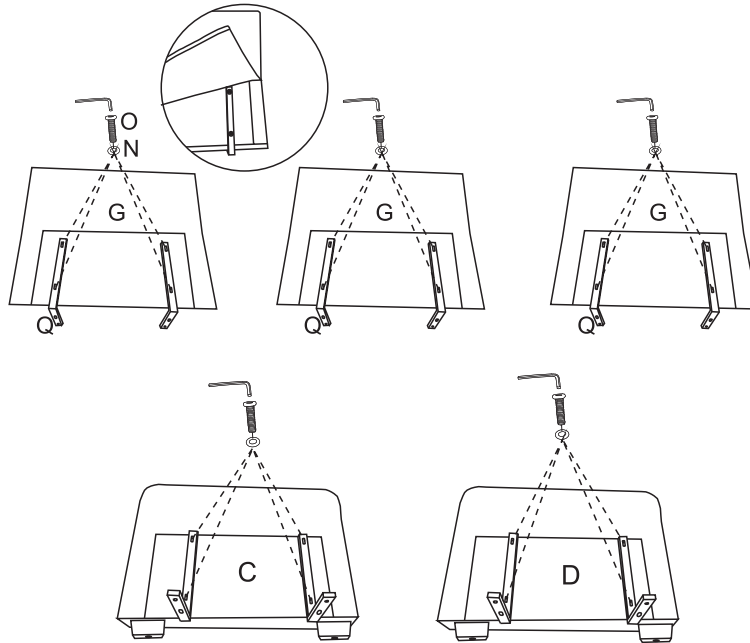

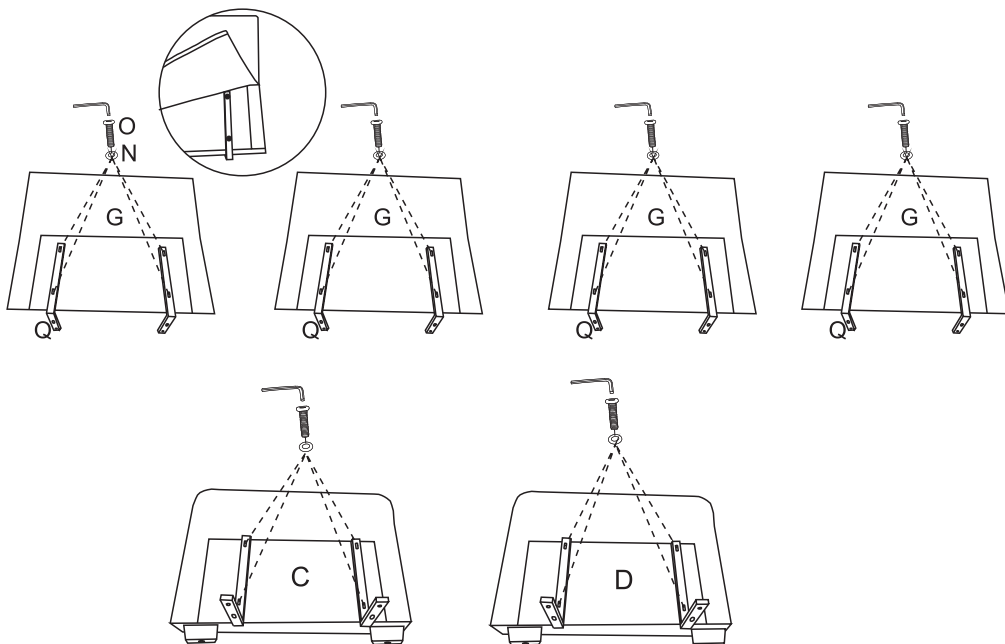

If you buy a four-seater two-seater footstool



STEP 4

Align the backrest (G) with the marked attachment points on the sofa base (as shown in the diagram), place a washer (N) and tighten with a bolt (O) to ensure a secure installation.

N		12PCS
O		12PCS

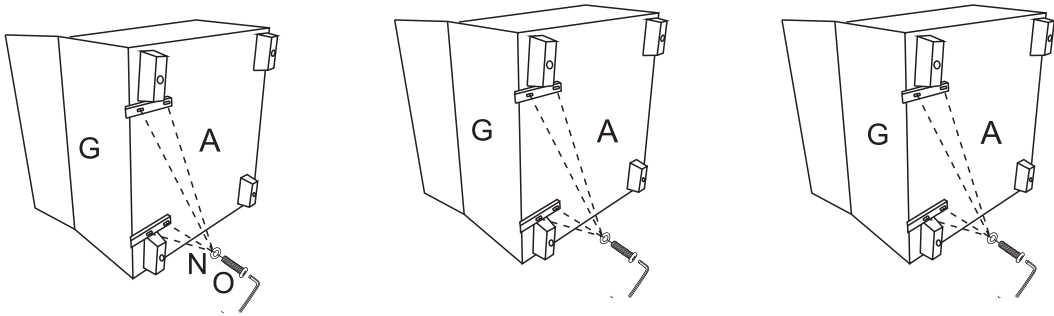

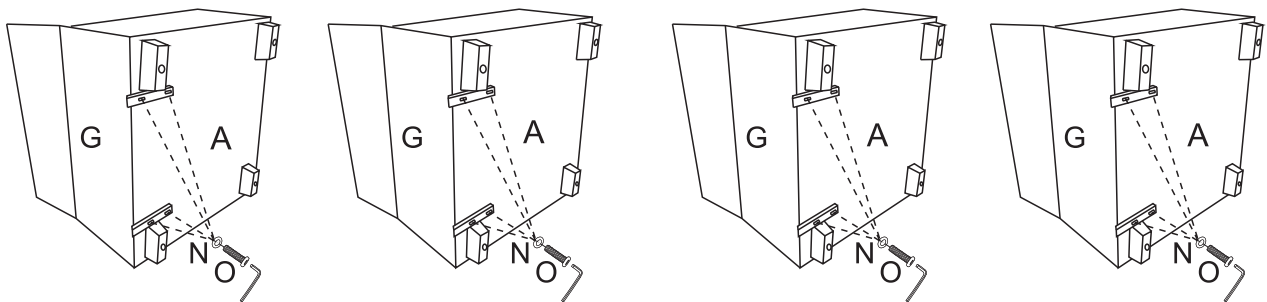

If you buy a four-seater two-seater footstool



STEP 5

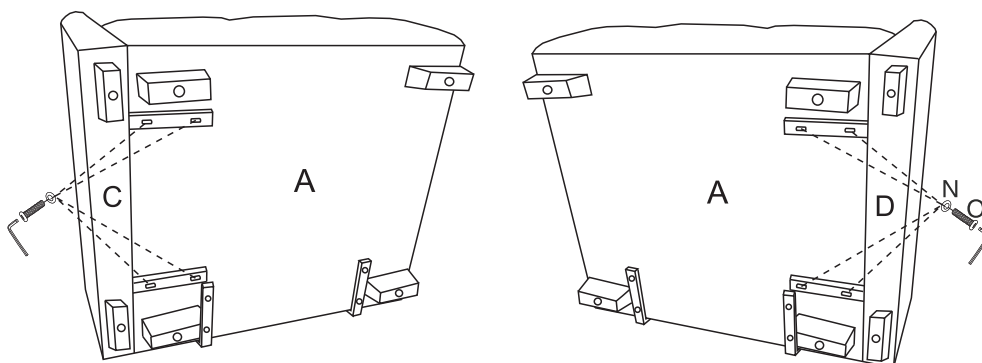

Align the left armrest (C) or right armrest (D) with the marked attachment points on the sofa base (as shown in the diagram), place a washer (N) and tighten with a bolt (O) to ensure a secure installation.

N		8PCS
O		8PCS



STEP 6

Use 4 Connecting irons (M), 8 Washers (N), and 8 Bolts (O) to connect 3 Seat cushions (A) together.

M		4PCS
N		8PCS
O		8PCS

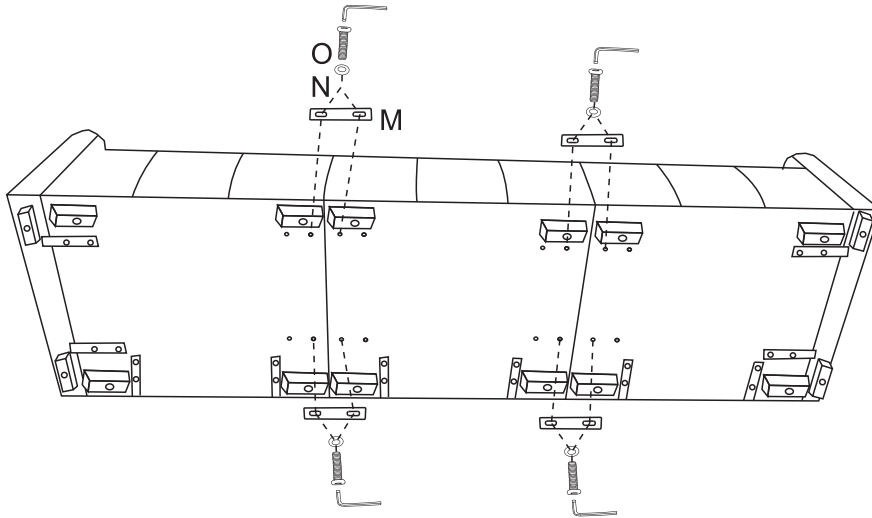

If you buy a four-seater two-seater footstool

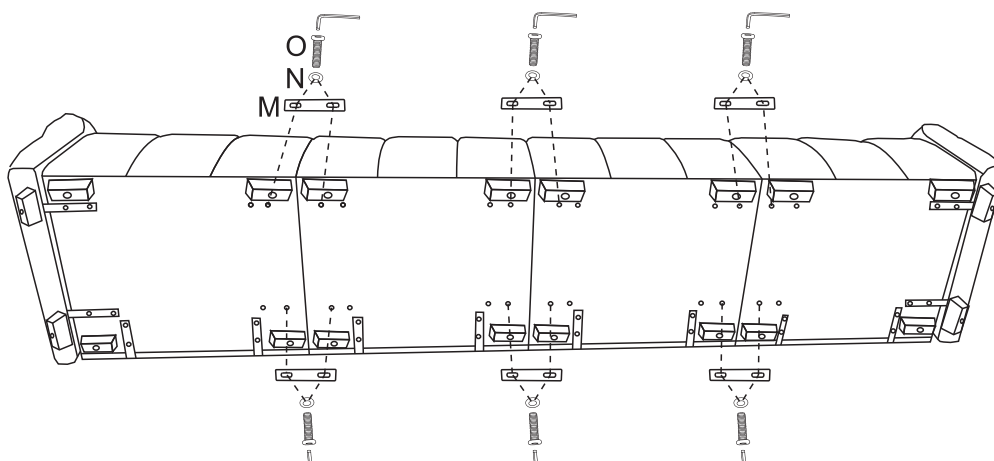

STEP 7

Place the cushions on the sofa.

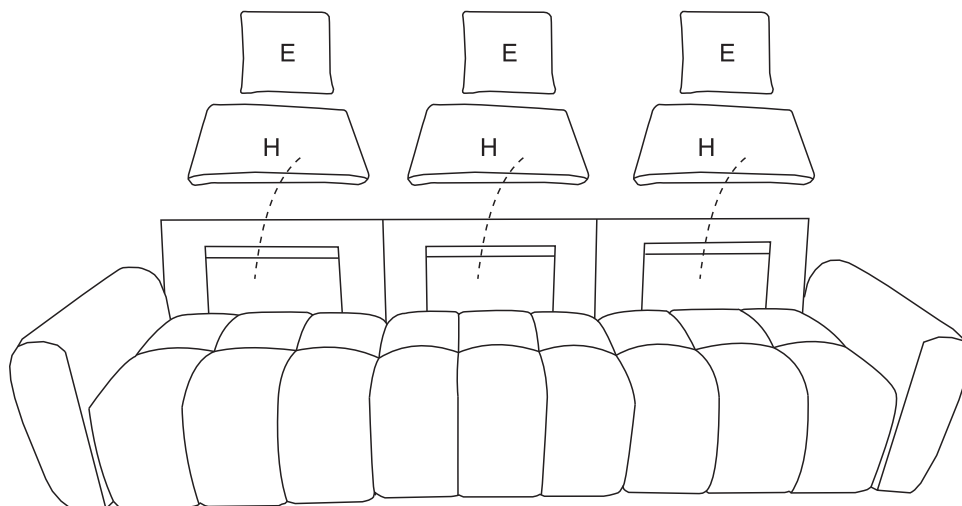

If you buy a four-seater two-seater footstool

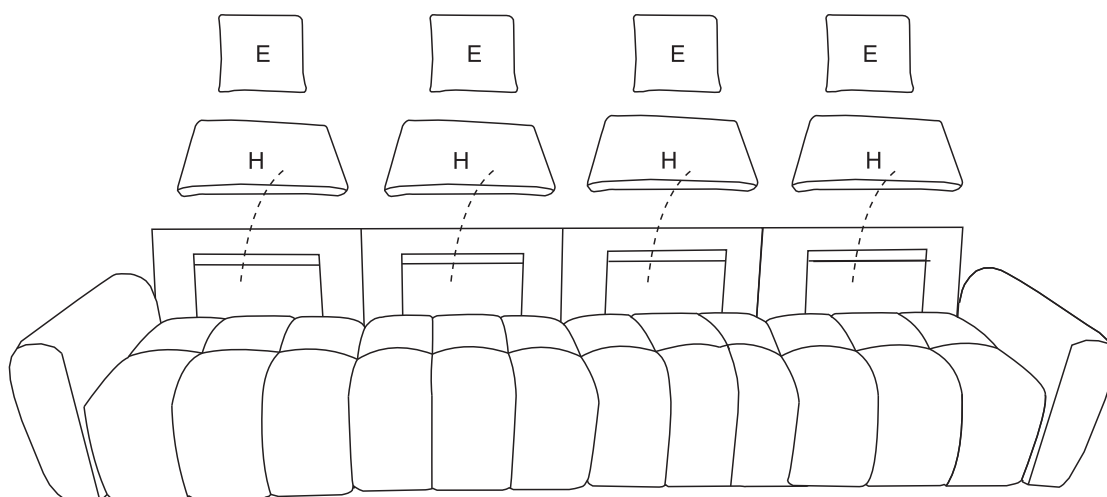

Complete assembly

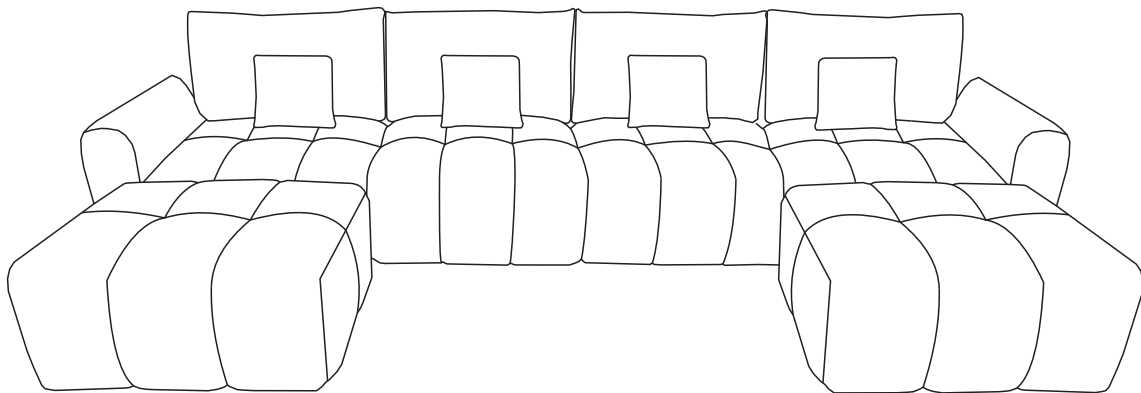
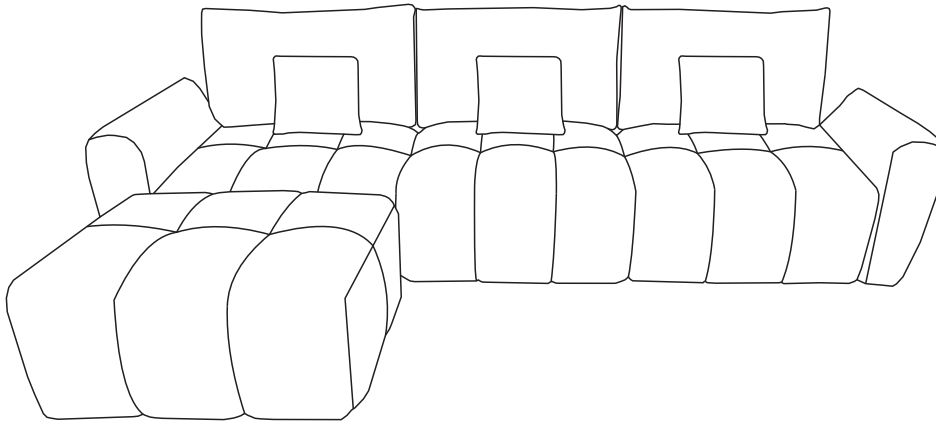

After assembly, it is recommended to let it sit for 72 hours before use to ensure optimal comfort.