

OFFICE CHAIR ASSEMBLY INSTRUCTION

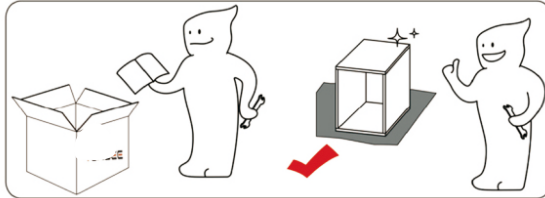

⚠ IMPORTANT

Please follow the instruction manuals and use a pad to avoid damage during assembly.

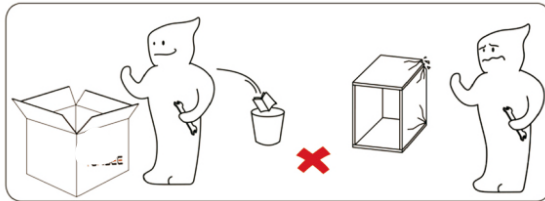

For easier and better assembly, 1 or more adults are required.



The expected assembly time for this product is 0.5 h, depending on the individual's manipulative ability.



Not intended for use by children. Please keep your children closely supervised.



Keep away from fire or other heat sources.



Do not use harsh cleaner for cleaning!



We recommend wearing protective gloves for assembly.



Identify, sort and count the parts before assembly.



The warning, cautions and instructions listed in this manual may not cover all possible situations that may arise when using the product. Please contact us via homelifeservice@hotmail.com if you need further help.

Q&A

Q: Where can I get installation instructions?

A: You can also contact us if you need an electronic instruction document or further assistance.

Q: Can I complete the installation independently?

A: if you need to install the chair independently, we recommend that you put the seat cushion on a higher table or chair to assist your installation. please refer to our instructions.

Q: How to adjust the lumbar support?

A: The height of the lumbar support can be adjusted by pushing the plastic slider up and down. (Please keep your back away from the backrest for smooth adjusting of the slider.)

Q: How to adjust if the chair is tilted forward?

A: It may be due to the wrong orientation of the tray and the seat cushion, please keep the tray and the seat cushion in the same direction as indicated.

Q: If the screws are not aligned with the holes during installation, how can I adjust them?

A: You can put the screws into the corresponding holes first, and tighten them halfway. And then fully tighten all the screws after the screws are set.

Q: What should I do if the package lacks some components?













A: Please feel free to contact us for prompt help if the package lacks some components.

Q: What should I do if my package were damaged?

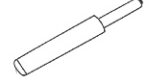
A: Long-distance transit may cause damage to the item under special circumstances, please feel free to contact us for prompt help.

Thanks for your support!

If you need further assistance, please feel free to contact our customer service team for prompt help, we will do our best to help you.

Please Make sure all parts are included			
 A	 B	 C	 C
Backrest - 1pcs	Seat Cushion - 1pcs	Left Armrest - 1pcs	Right Armrest - 1pcs
 D	 E	 F	 G
Tray - 1pcs	Base - 1pcs	Gas Lift - 1pcs	Wheel - 5pcs
 H	 H	 I	 J
Screw(M6*25) -8pcs	Screw(M6*20) -4pcs	Wrench - 1pcs	Wrench - 1pcs
			
K			
Washer -4pcs			

**Notice: Before installation, please classify the screw, measure the screw length for easy assemble
(Each screw comes with 1 backup)**

STEP 1

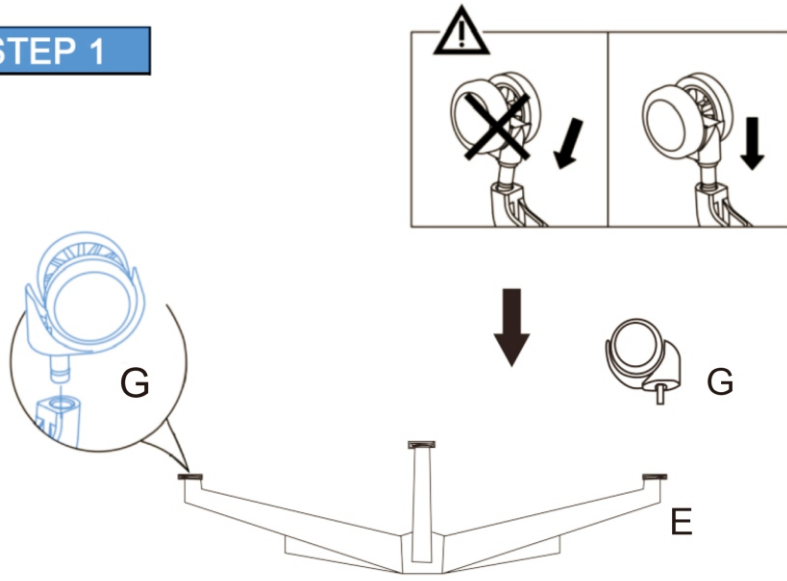

Push the wheels to the base.

STEP 2

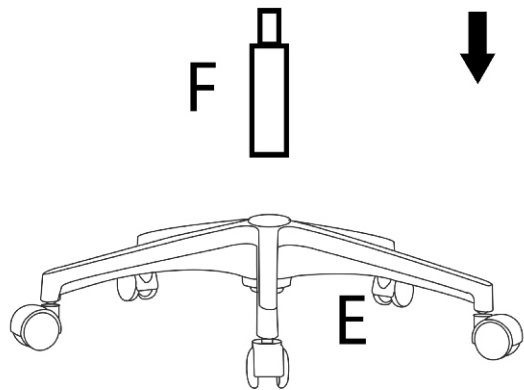

Put the gas lift on the base.



! NOTE

1. When lowering down the seat height, please make sure to fully sit on the seat (as the right figure shows below) in order to give it enough pressure.
2. This chair cannot be locked when inclined;
3. When you want to use the rocking mode, first please pull out the lever to activate the rocking mode, lean your back, then you can recline the chair;
4. This chair has adjustable Lumbar Support, please adjust the Lumbar Support to find the best back support for you.

UK REP

Name: Sea&Mew Accounting Ltd
 Address: Electric Avenue Vision
 25, London, Enfield EN3 7GD
 Contact Person: Billy Han
 E-mail: info@seamew.net
 Tel: +44 7399648608



Filling material(s) and covering fabric(s) meet the requirements for resistance to cigarette and match ignition in the Furniture and Furnishings (Fire) (Safety) Regulations 1988

**CARELESSNESS
 CAUSES FIRE**

Setup Method

Tips 1: Height Adjustment

press the lever to adjust the seat height up and down

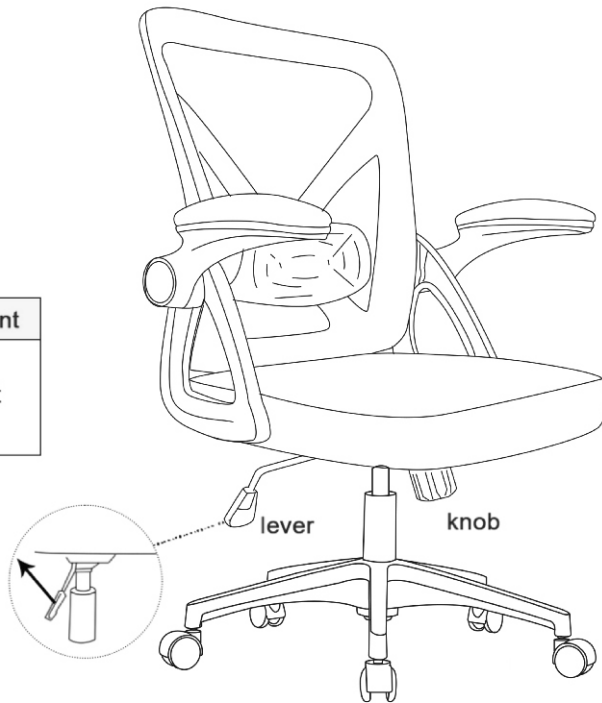

Tips 2: Tilt Tension Adjustment	
<p>• lever</p>	<p>• knob</p>
<p>Step 1 pull out the lever to activate the rocking mode</p>	<p>Step 2 twist the knob to control the tilt tension</p>

STEP 3

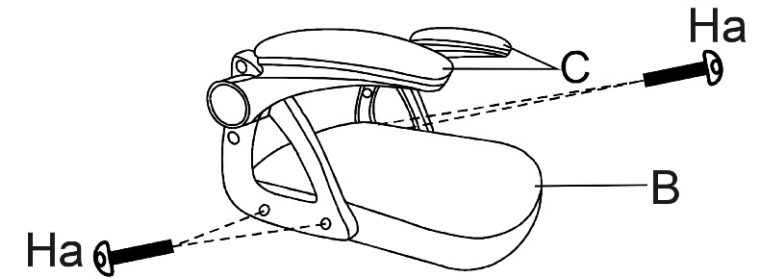

Please assemble the armrests and seat cushion firstly.

! NOTE

Note: During the assembly, please first half-tighten all the screws into the holes. After all the screws are set, fully tighten them.

STEP 4

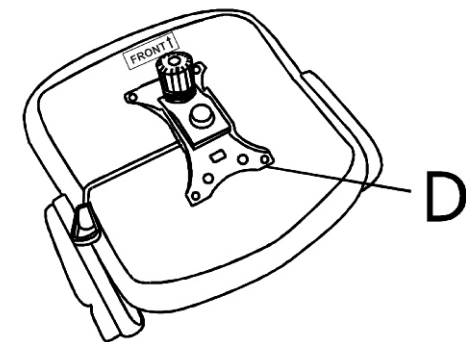

Please notice the direction of the tray and the seat cushion
Keep the same direction as indicated

STEP 5

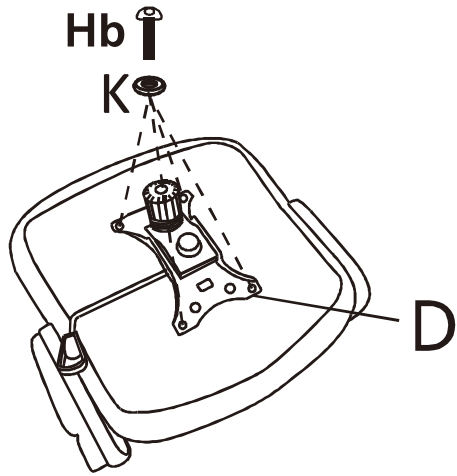

Attach the seat control on the seat cushion.
Please notice the direction!

STEP 6



Assemble the chair with two whole parts.

STEP 7

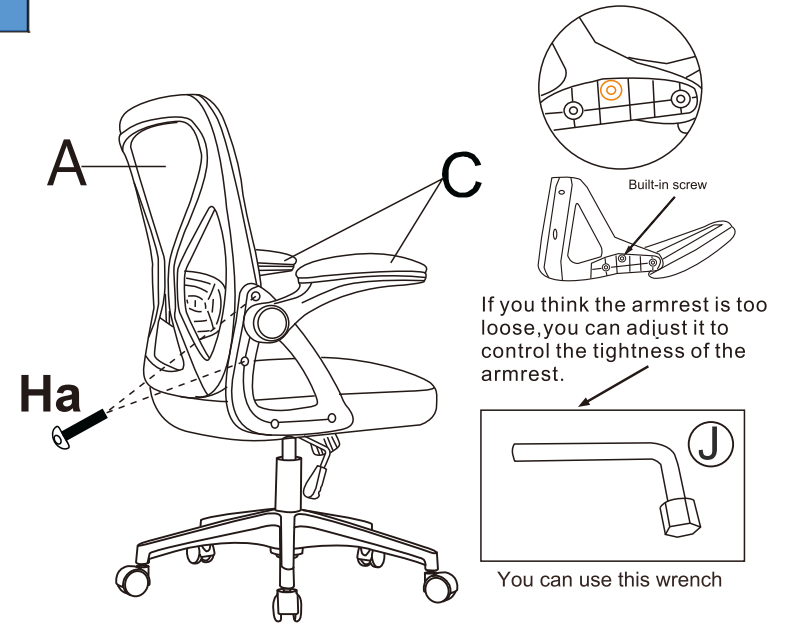

STEP 8

