

ASSEMBLY INSTRUCTION

ASSEMBLY INSTRUCTION

ASSEMBLY TIPS :

- 1.Remove hardware from box and sort by size.
- 2.Please check to see that all hardware and parts are present prior to start of assembly.
- 3.Please follow attached instructions in the same sequence as numbered to assure fast & easy assembly.



Warning !

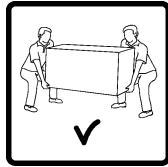

- 1.Don't attempt to repair or modify parts that are broken or defective.Please contact the store immediately.
- 2.This product is for home use only and not intended for commercial establishment.





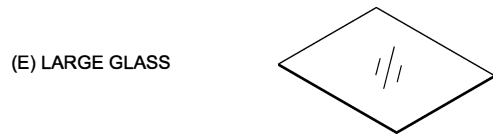
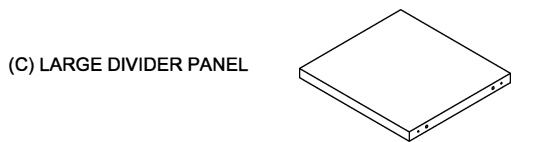
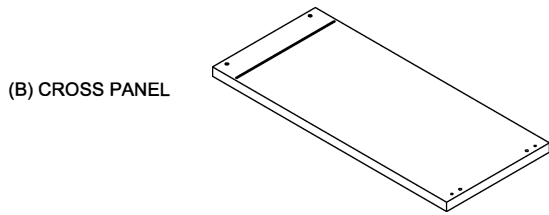
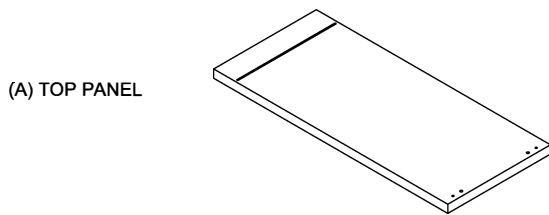

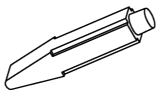
ASSEMBLY TIME PER UNIT: 30 MINUTES

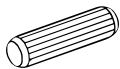
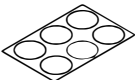
PARTS IDENTIFICATION:

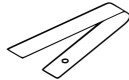

Z HARDWARE PACKAGE							
NO	DESCRIPTION	FIGURE	Q'TY	NO	DESCRIPTION	FIGURE	Q'TY
1	GLUE 15g		1PC	3	BOLT ϕ 9.5x55mm FOR BOTTOM PANEL		16PCS
2	WOODEN DOWEL ϕ 8x30mm		16PCS	4	STICKER ϕ 20mm		3PCS

Z	HARDWARE PACKAGE						
NO	DESCRIPTION	FIGURE	Q'TY	NO	DESCRIPTION	FIGURE	Q'TY
5	ANTI-TIP STRAP 170x15mm		2PCS	7	WALL SCREW Ø4x25mm		2PCS
6	WALL PLUG 6x30mm		2PCS	8	SCREW Ø4x16mm		2PCS

STEP 1 :

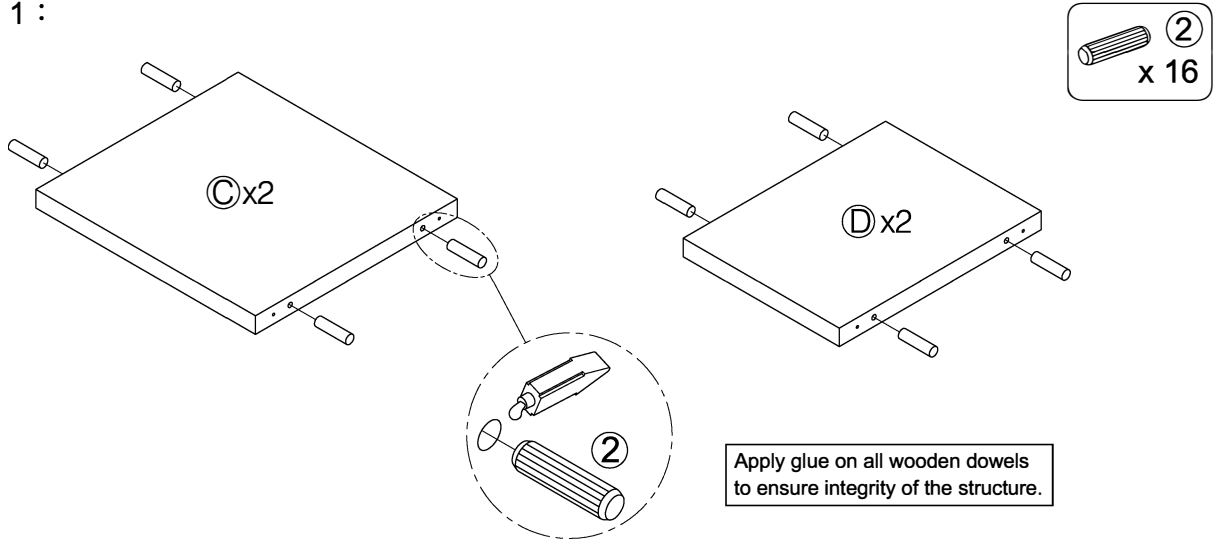

STEP 2 :

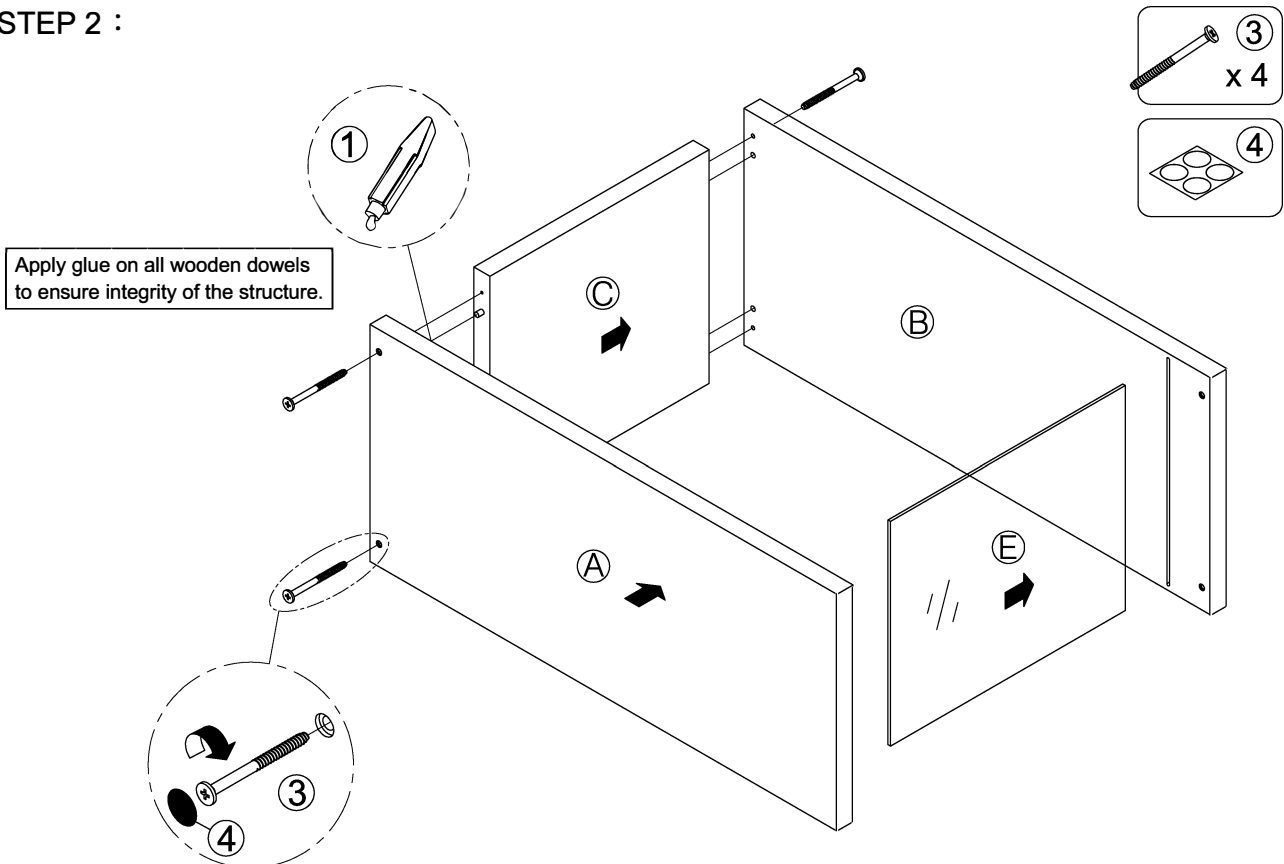

STEP 3 :

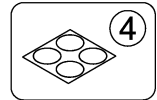
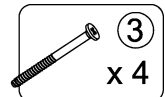
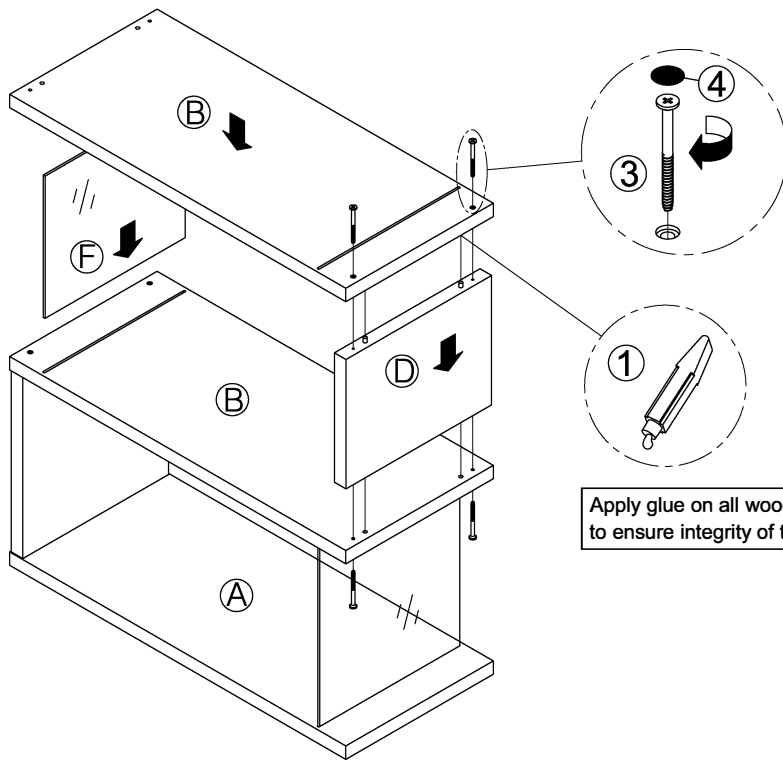

Apply glue on all wooden dowels to ensure integrity of the structure.

STEP 4 :

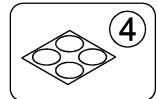
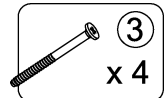
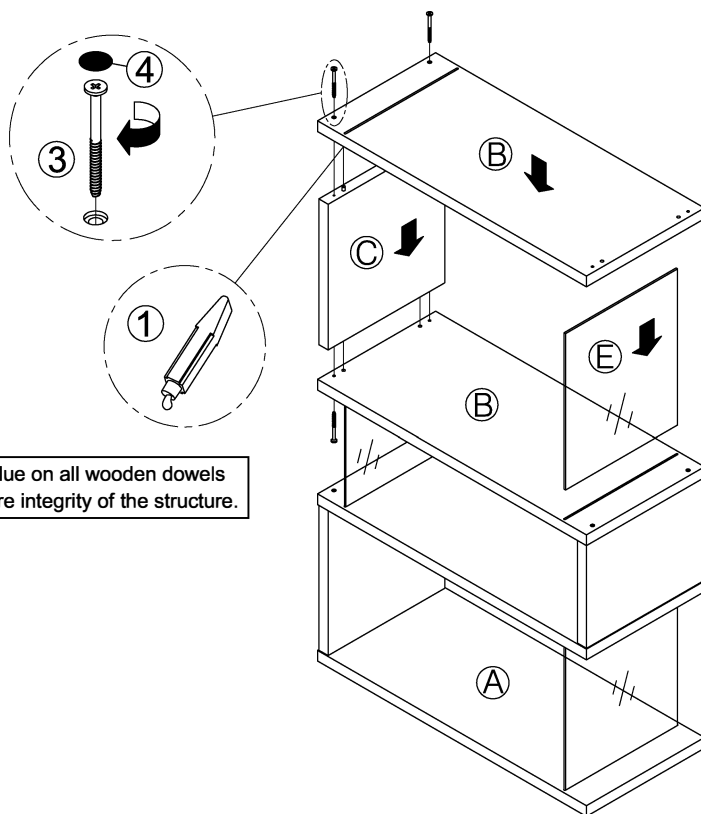

Apply glue on all wooden dowels to ensure integrity of the structure.

STEP 5 :

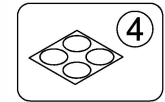
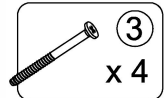
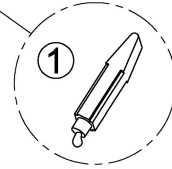
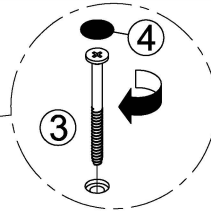
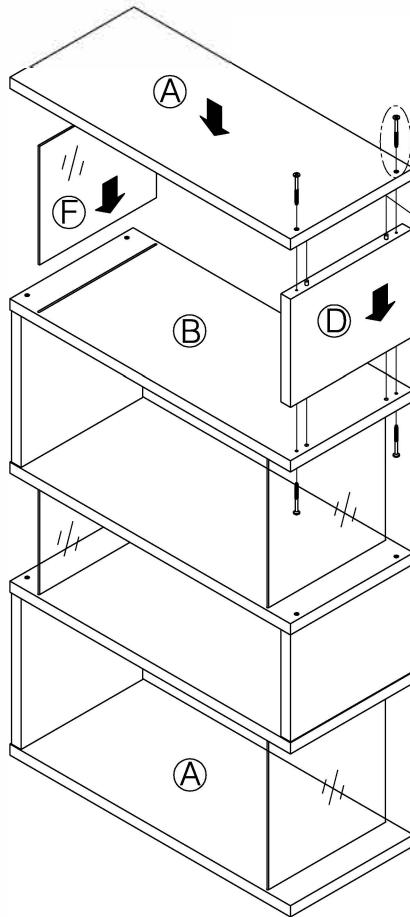

Apply glue on all wooden dowels to ensure integrity of the structure.

STEP 6 : **ATTENTION: ANTI TIPPING SAFEGUARD**

Please install the anti-tipping hardware as shown in the drawing. This can help to prevent any tipping issues.

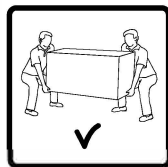
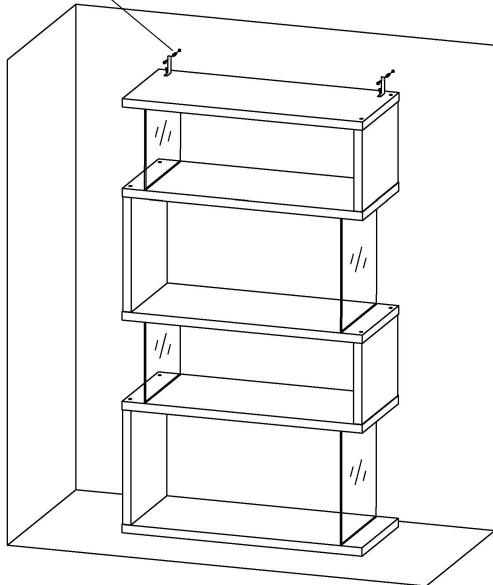
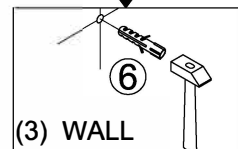
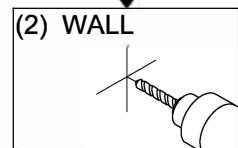
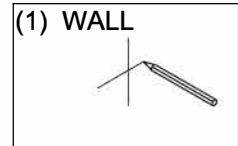
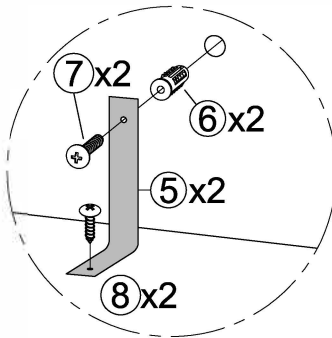

FURNITURE TIPPING RESTRAINT

WARNING

Injury may result from tipping furniture
 This restraint is not a substitute for proper adult supervision.
 This restraint may provide protection against tipping furniture.
 Do not allow children to climb on furniture.
 Failure to detach this restraint before moving furniture may
 result in injury and damage