

Assembly Instruction

CAUTION: Read instruction carefully and turn electricity off at main circuit. breaker panel before beginning installation.

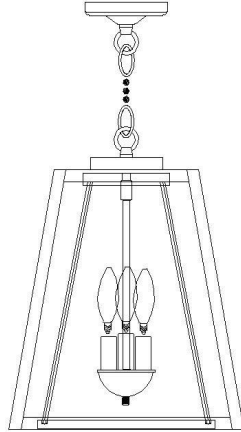







Care and Cleaning

To clean the outside of the fixture, use a dry or slightly dampened clean cloth (use clean water, never a solvent) to wipe the surface of the fixture.

To clear the inside of the fixture, first disconnect power to the fixture by turning off the circuit breaker or by removing the fuse at the fuse box. Next, use a dry or slightly dampened clean cloth (use clean water, never a solvent) to wipe the interior surface of the fixture. Do not use any cleaners with chemical, solvents or harsh abrasives. Use Only a dry soft cloth to dust or wipe carefully.

Estimated Assembly Time: 10 minutes

Part List and Hardware List

PIECE	DESCRIPTION	PICTURE	QUANTITY	PIECE	DESCRIPTION	PICTURE	QUANTITY
A	Lamp Body		1	F	Screws	 $\phi 4 \times 25$	2
B	Light bulb		3	G	Nut		2
C	Eight hanging board		1	H			
D	Screws	 $\phi 4 \times 25$	2	I			
E	Terminal Cap		3	J			

PLEASE USE TYPE "B" BULB MAX 40W OR CFL BULB MAX 13-WATT OR LED BULB MAX 9WATT

Installation

Step 1:

Unpack all parts from cartons carefully.
Install the light bulb(B) at recommended wattage to socket.

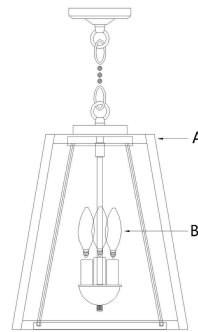

Step 2 Wire connection

Connect,Hot,Black or Red outlet Supply Wire to:	Connect,Neutral,White Outlet Supply Wire to: Black White
Black	White
*Parallel Cord(round&smooth)	*Parallel Cord(square&ridged)
Clear,Brown,Gold or Black without Tracer(colored stripes)	Clear,Brwn,Gold or Black without Tracer(colored stripes)
Insulated Wire(not green)with copper metal conductor	Insulated Wire(not green)with Silver metal conductor

*Note: When parallel wire(SPTI&SPTII)is used. The neutral wire is square shaped and ridged and the hot wire will be round in shape and smooth. (Like the one on the right)

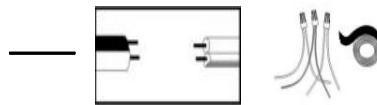

Grounding Instructions:

- For installation in the United States: Wrap ground wire from outlet box around green ground screw on mounting bracket, no less than 2" from wire end. Tighten ground screw. If fixture is supplied with a ground wire, connect to outlet ground wire with a wire connector.
- For installation in Canada: If fixture is supplied with ground wire, wrap ground wire around green grounding screw on mounting bracket. Tighten ground screw.

Step 3 :

Fix eight hanging board (C) with screw (D) to outlet box

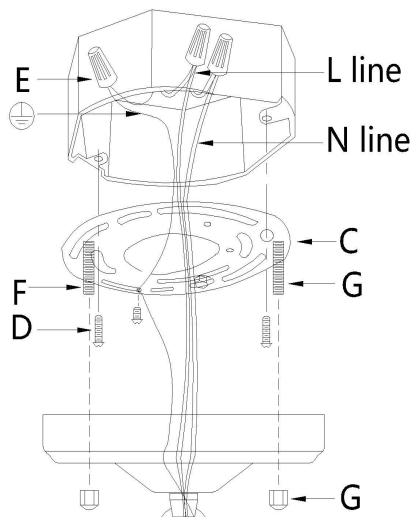

Step 4 :

Fix lamp body (A) with nut (G) to screw (F) of eight hanging board (C).

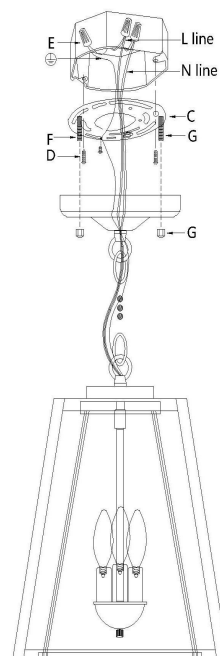

Step 5:

Consult a qualified electrician to ensure correct branch circuit conductor.

ENJOY YOUR LAMP