

Dimensions	Width	Depth	Height
Inches	29.49"	19.57"	34.49"

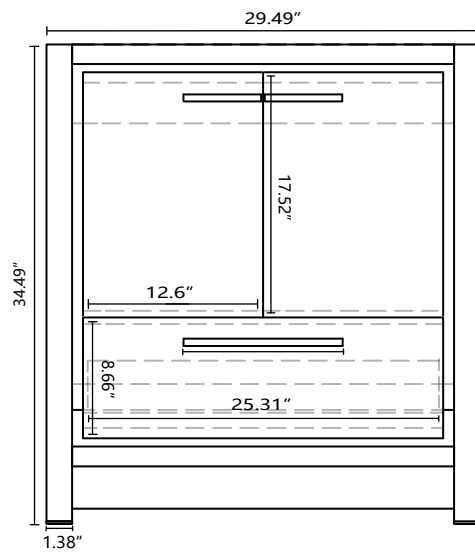

Front Elevation

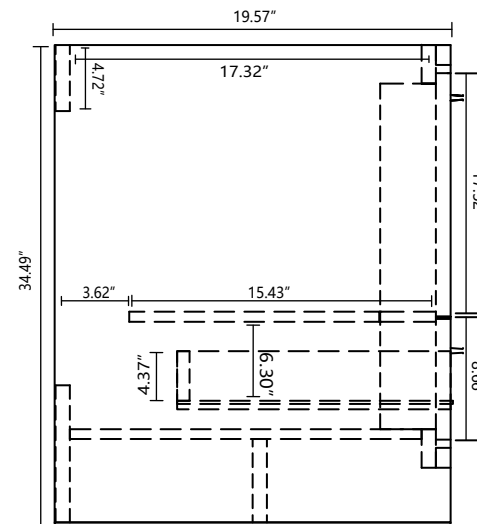

Side Elevation

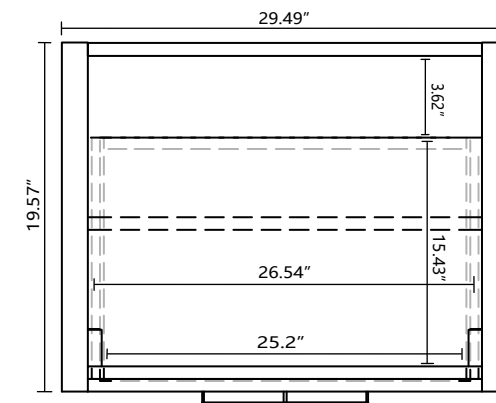





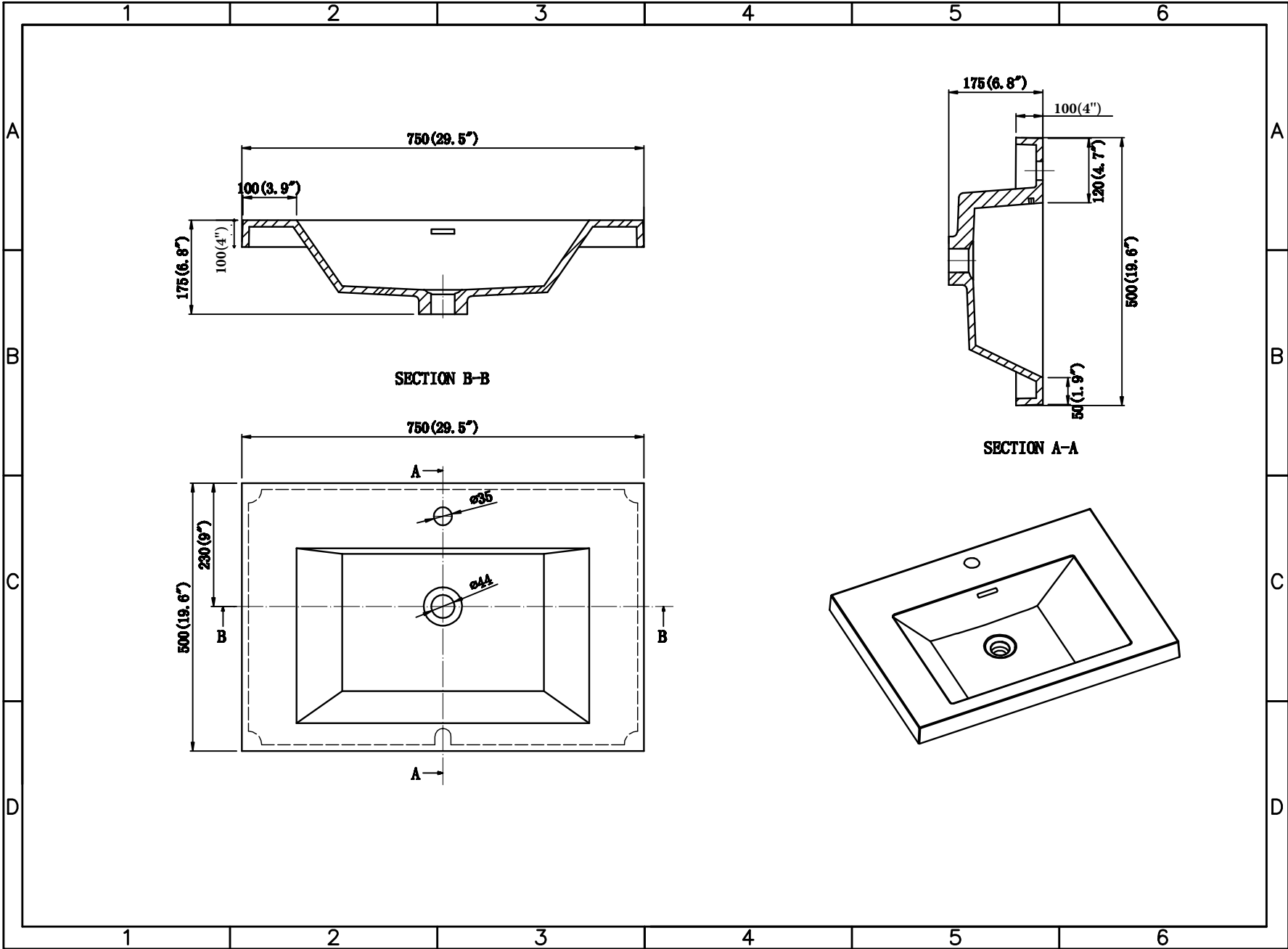

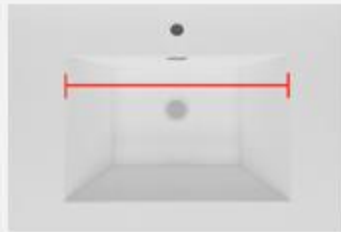
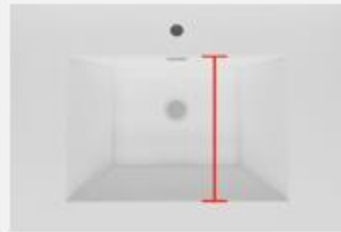

Top Elevation

Drawer Board Thickness 0.67"



BASIN DIMENSIONS (inch)

Sink Size	Length (from left to right)	Width (from front to back)	Depth (from top to bottom)	Distance between the side of the faucet hole and the back edge of the basin	Distance between the center of the faucet hole and the back edge of the top	Distance between the center of the drain hole and the back edge of the top	Distance between the center of the faucet/drain hole and closer side edge of the top	Distance between two faucet/drain holes (center to center)	Distance between the two basins
									
24" SINK	19	13	5	1.75	2.5	9.25	12	/	/
30" SINK	21.25	13	5	1.75	2.5	9.25	15	/	/
36" SINK	21.25	13	5	1.75	2.5	9.25	17.75	/	/
42" SINK	21.25	13	5	1.75	2.5	9.25	21.25	/	/
48" SINK	24	13	5	1.75	2.5	9.25	23.5	/	/
60"S SINK	24	13	5	1.75	2.5	9.25	29.5	/	/
60"D SINK	21.25	13	5	1.75	2.5	9.25	14.75	29.5	8
72"D SINK	21.25	13	5	1.75	2.5	9.25	17.75	35.5	14
84"D SINK	24.25	13	5	1.75	2.5	9.25	21	41.5	17.5

Faucet Hole: ϕ 1.35

Drain Hole: ϕ 1.75