







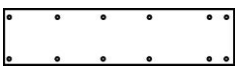

CARE AND MAINTENANCE

Always use felt pads under all articles to prevent discoloration or softening of the lacquer. Plastic and rubber bases on items can discolor wood. Wipe up spills immediately and avoid common hazards such as hot dishes, harsh solvents and abrasives. Cleaning should be done with a soft lint free cotton cloth dampened with water or furniture polish. On highly used surfaces we recommend applying a quality paste wax which should be used on a regular basis to provide additional protection from scratches and spills. How often you apply the wax depends on how much wear the furniture receives.

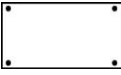
NOTICE





- * Please make sure that you have all parts indicated before you begin assembly of this item
- * This item should be assembled on a soft surface to prevent scratching the finish during assembly
- * This item may require periodic tightening

Part List and Hardware List

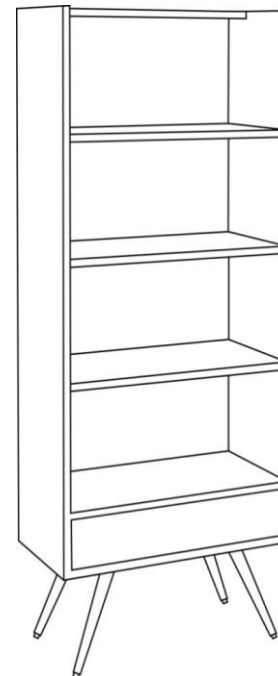
A	Side panels		2X
B	Box		1X
C	shelf		3X
D	Top Panel		1X
E	Metal legs		4X
H1	Allen bolt L	 M6X30mm	8X
H2	Allen bolt S	 M6X15mm	16X
H3	Screw		16X
H4	Allen key		1X

Product Dimensions: 25-1/5"W X 11-4/5"D X 63"H



H5	Nylon Strap		2X
H6	Long Screw	 M4*25mm	2X
H7	Plastic Screw Anchor		2X
H8	Wall Bracket		4X
H9	Short Screw	 M3*16mm	2X

PREPARATION

Before beginning assembly of product, make sure all parts are present. Compare parts with package contents list and hardware contents list.

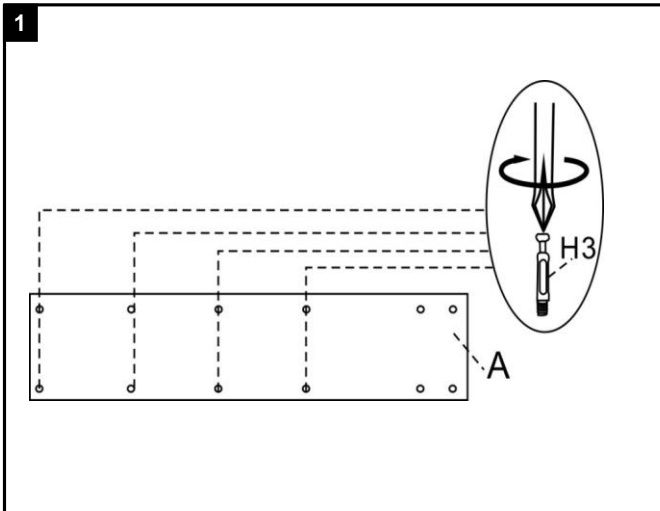

Step 1
Attach the Screw(H3) to Side panel(A)
Tighten with philps driver

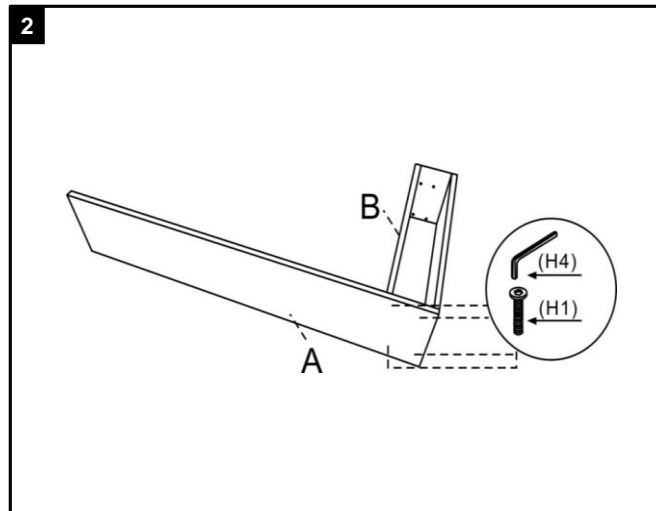

Step 2
Attach the Box(B) to Side panel(A), using Allen bolt(H1)
Tighten with Allen key(H4)

3

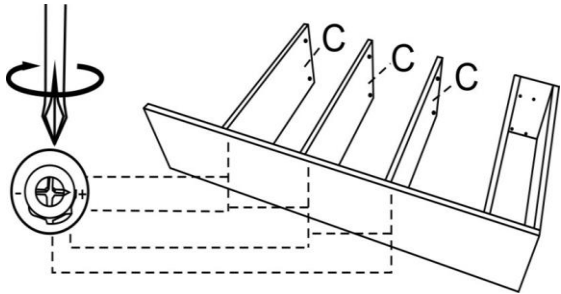

Step 3
Attach the Shelf(C)to Side panel(A)
Tighten with philips driver

4

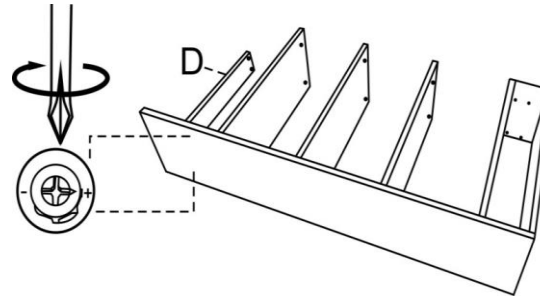

Step 4
Attach the Top panel(D)to Side panel(A)
Tighten with philips driver

5

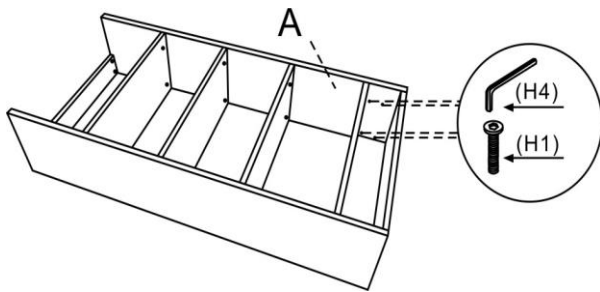

Step 5
Attach the Side panel(A)to the Box(B), using Allen bolt(H1)
Tighten with Allen key(H4)

6

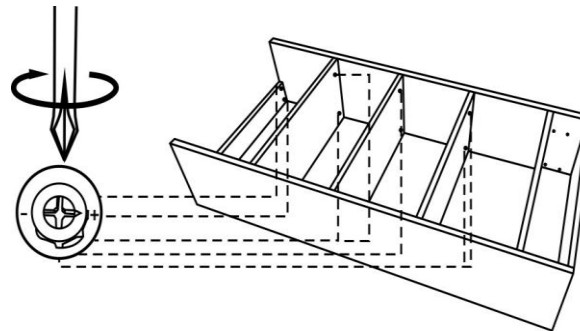

Step 6
Attach the Top panel(D)and Shelf(C)to Side panel(A)
Tighten with philips driver

7

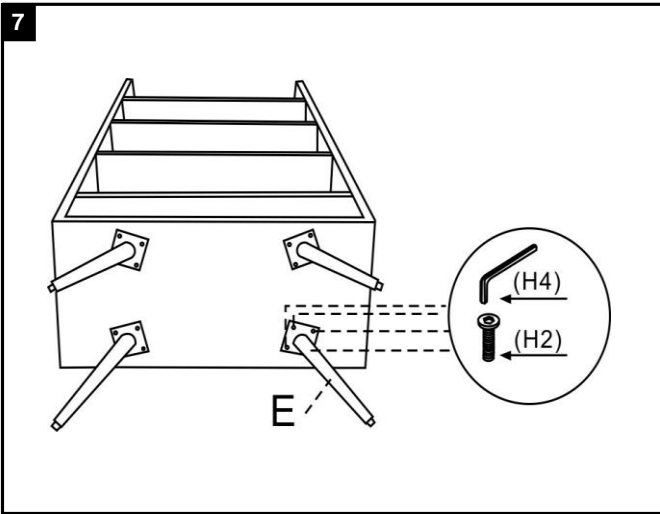

Step 7
Attach the Metal legs(E) to Box(B),using Allen bolt(H2)
Tighten with Allen key(H4)

8



Step 8
For safety concerns, please use the Anti-tip kit with this product