





ASSEMBLY INSTRUCTIONS

DESCRIPTION: CHEST

Thank you for purchasing this quality product. Be sure to check all packing material carefully for small parts, which may have come loose inside the carton during shipment.

HARDWARE LIST			
A		1/4" * 1"	8pcs
B		1/4"	8pcs
C		1/4" * 16mm	8pcs
D		4 mm	1pc

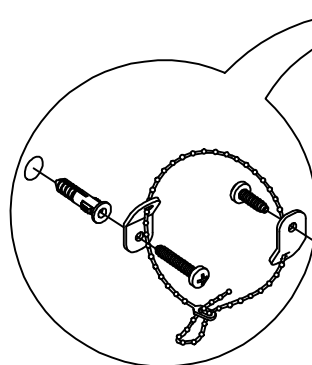
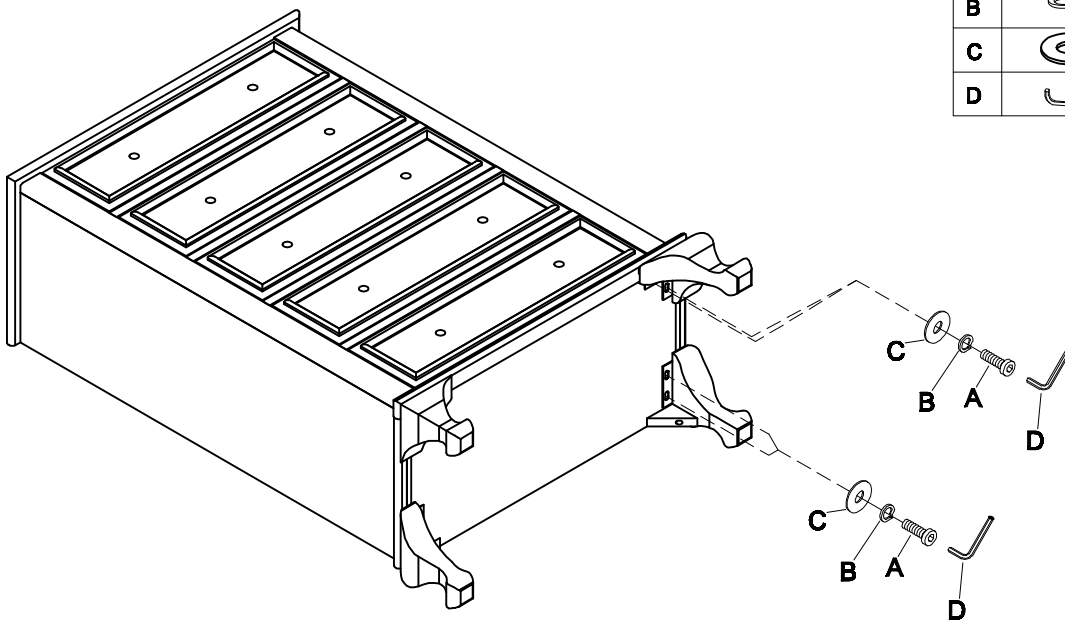

Anti -Tip kit

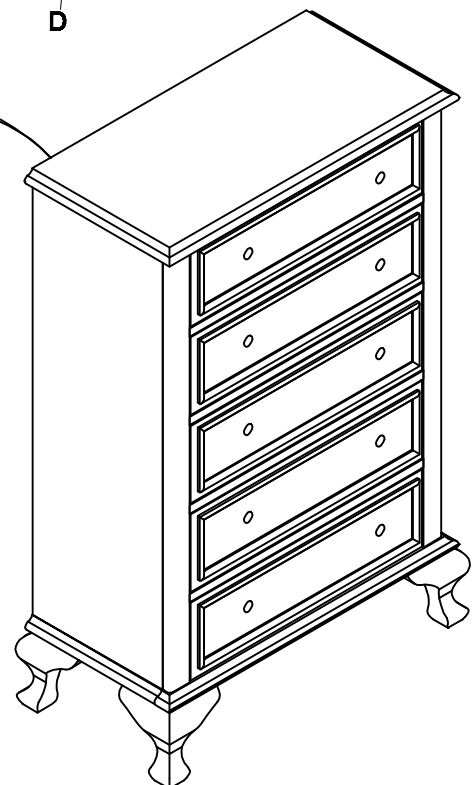

MADE IN VIETNAM