

ASSEMBLY INSTRUCTIONS

IMPORTANT - Please retain this information for future reference and read carefully before starting.
HELPLINE - If you need assistance with this product or need to order replacement fitting please contact our **CUSTOMER HELPLINE**

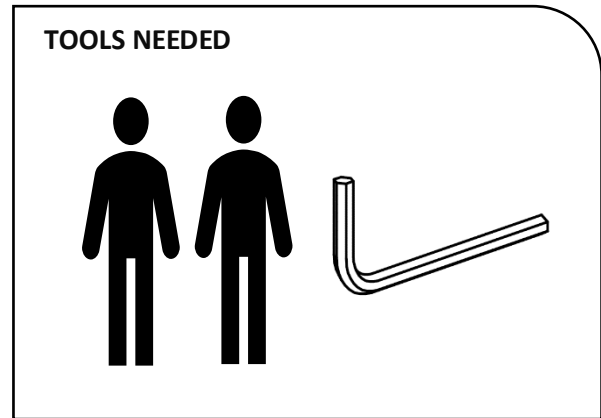
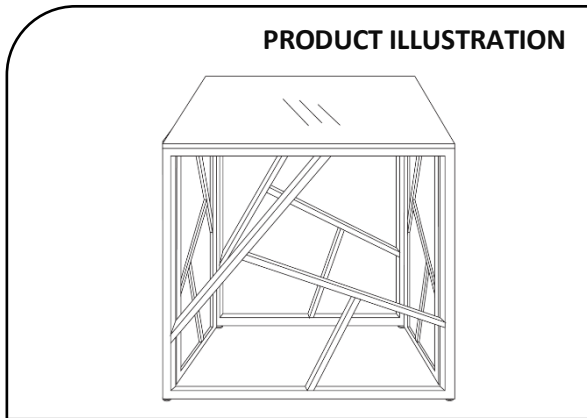

SELF ASSEMBLY ITEMS CANNOT BE RETURNED ONCE ASSEMBLY IS PARTLY OR FULLY COMPLETED UNLESS THE ITEM IS FOUND TO BE FAULTY. SHOULD YOU NEED TO RETURN THE UNASSEMBLED PRODUCT, PLEASE REPACK IN THE ORIGINAL PACKAGING, ENSURING ALL COMPONENTS ARE INCLUDED.

IMPORTANT - PLEASE READ BEFORE STARTING







- * FOLLOW THE INSTRUCTIONS ON THE STEP BY STEP GUIDE.
- * PLEASE UNPACK CAREFULLY AND PLACE ALL PARTS ON A SMOOTH SURFACE
- * ENSURE ALL TOOLS AND COMPONENTS ARE COMPLETE BEFORE STARTING THE ASSEMBLY.
- * KEEP FITTINGS OUT OF CHILDRENS REACH AND KEEP CHILDREN AWAY FROM ASSEMBLY AREA.
- * ENSURE YOU HAVE ENOUGH ROOM FOR CONSTRUCTION.
- * PACKAGING MAY BE USED TO PROTECT PRODUCT DURING ASSEMBLY.
- * NOT SUITABLE FOR USE IN AREAS WITH HIGH HUMIDITY – eq. BATHROOMS.
- * MINIMUM OF TWO PEOPLE ARE REQUIRED TO ASSEMBLE THIS PRODUCT.

CARE INSTRUCTION

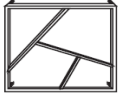
This product care will guide you on the best way to care for your product to maximize their guaranteed life. Protect from direct sunlight. The location of your product can affect its durability, thus placing it too close to high-temperature appliances can increase the risk of scorching damage or discoloration and placing the item where it can touch external walls can create moisture build-up. Sharp objects and even the claws of your pets can tear, scratch or break the product.

- * Periodically wipe clean with a soft dry cloth and/or non-abrasive cleaner.
- * Do not rub or scrub the surface when cleaning.
- * Take precautions in using vacuums and use low suction as much as possible to maintain product integrity.
- * Do not strike the material with hard or pointed items.
- * Do not use abrasive and harsh cleaning products.
- * Do not sit or stand on products otherwise indicated.
- * If liquid spills do occur, wipe or blot with dry clean cloth as soon as possible.
- * Avoid direct and continuous exposure to sunlight.
- * Care must be taken in using coloured cleaning materials as it may transfer or stain products.
- * Always follow cleaning product guide/manual on any cleaning product used.
- * Dragging, pulling, and dropping any product is not recommended.
- * Do not place items with extreme temperature on the product as it may cause brittleness.

ASSEMBLY PARTS

							
Ax1	Bx2	Cx2	Dx16	Ex16	Fx1	Gx4	Hx4

STEP 1

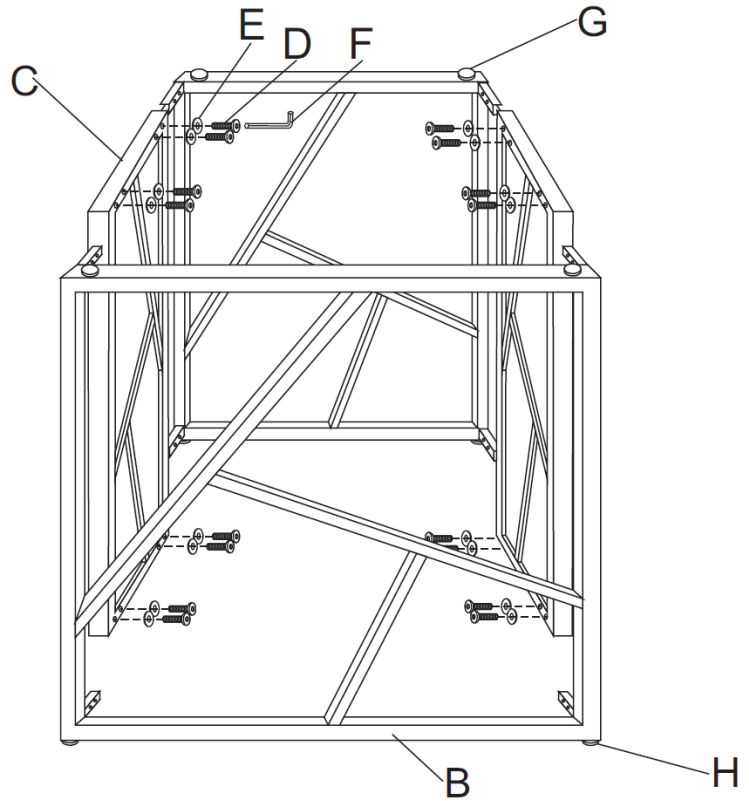

CAUTION: CAREFULLY TURN THE TABLE IN UPRIGHT POSITION AFTER ASSEMBLY.

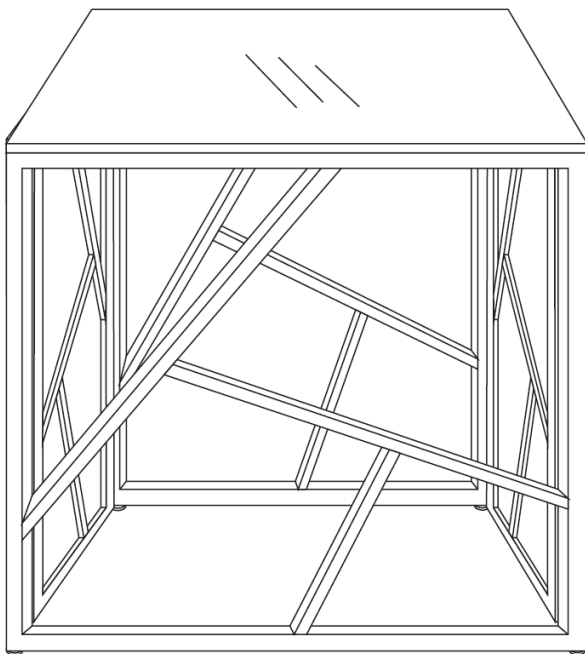

STEP 2