

# ASSEMBLY INSTRUCTIONS

## BUNKBED

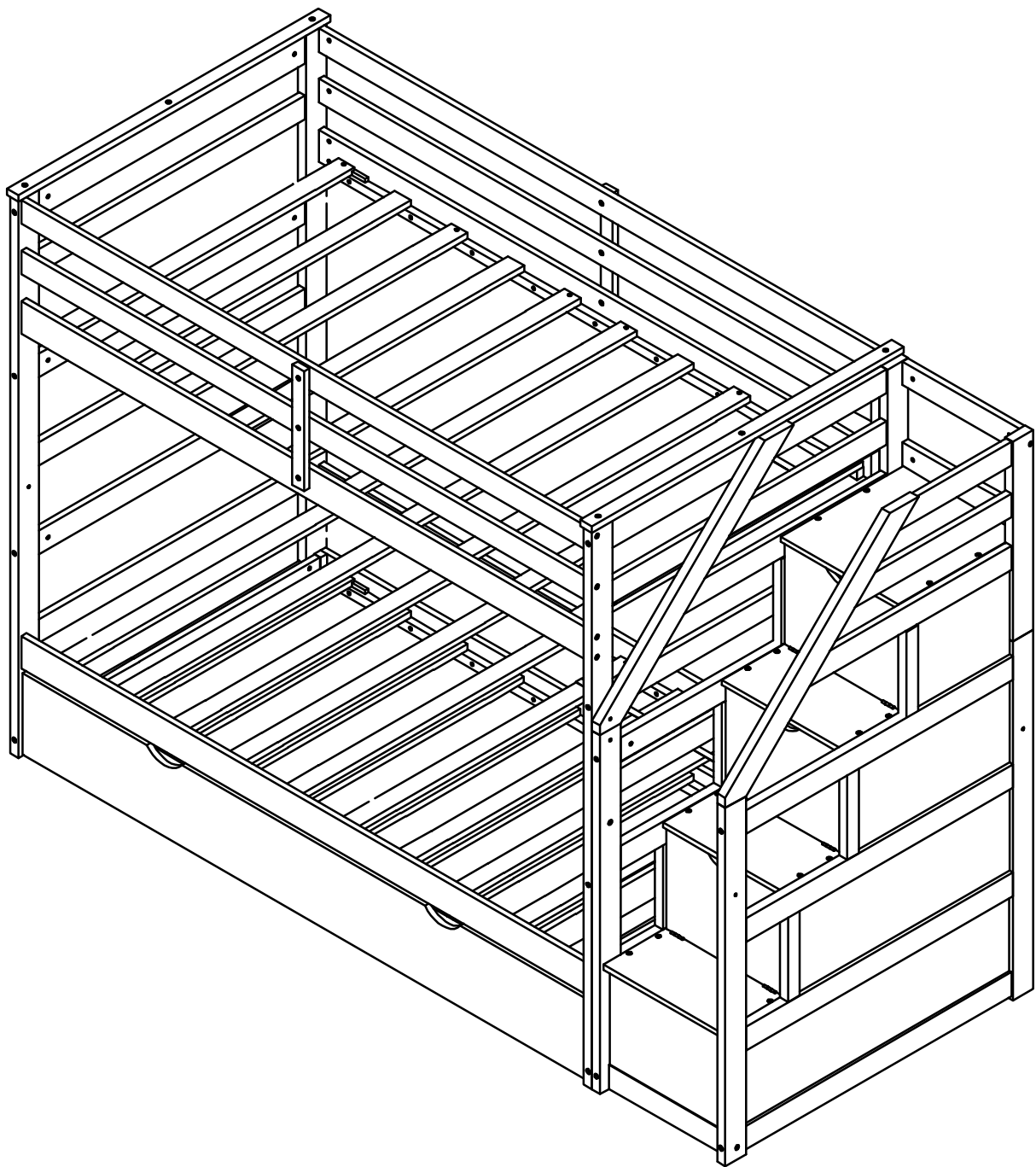





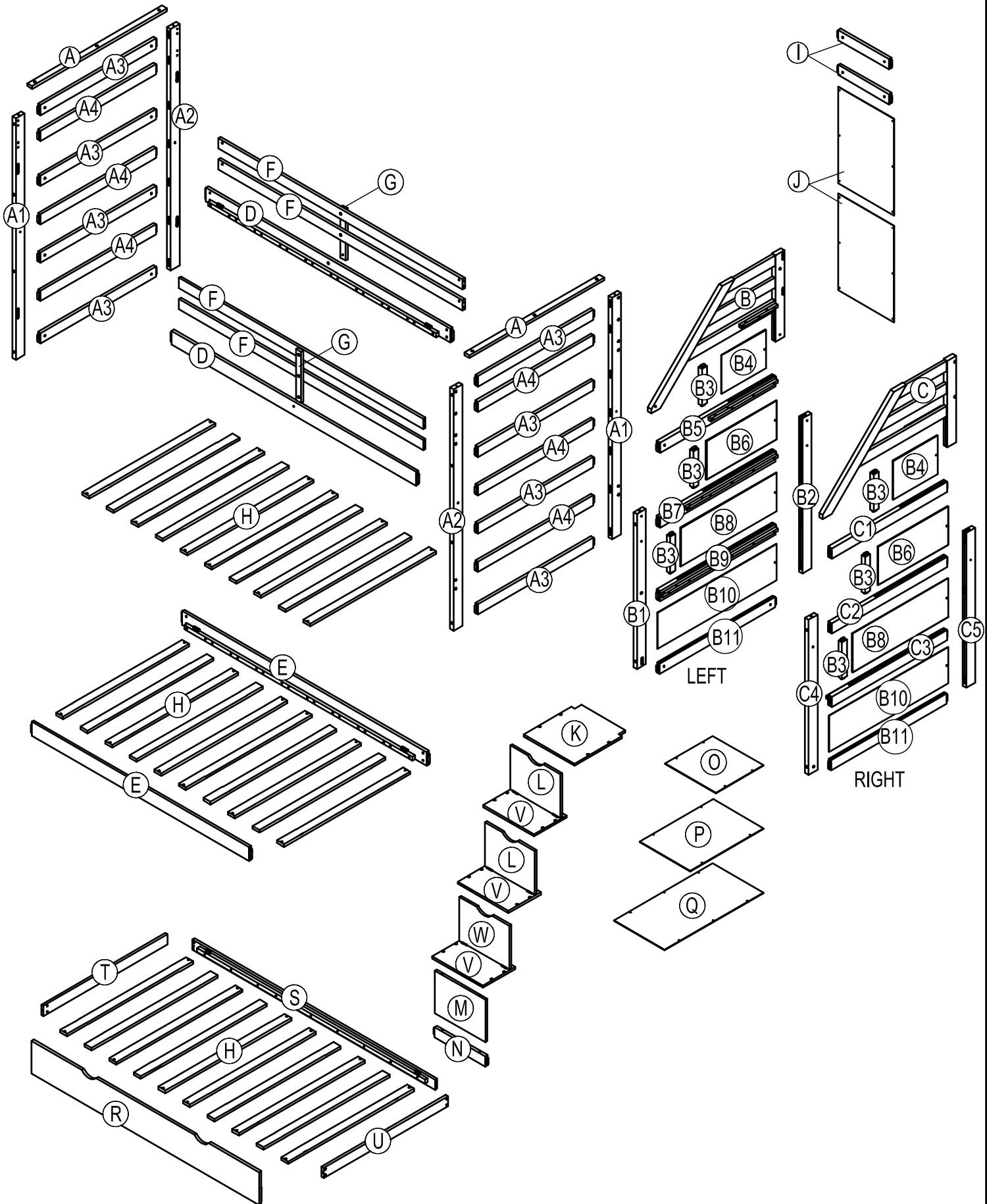



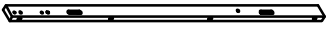

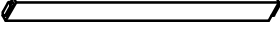



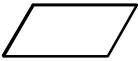
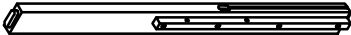





WF192077/WF192078/WF192079

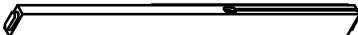

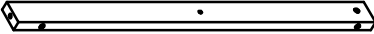

# DetailView







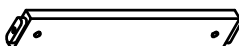
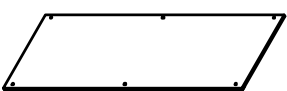
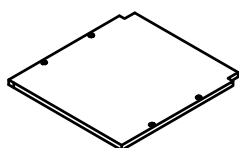
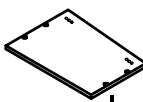
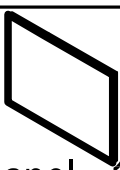
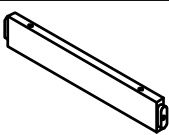
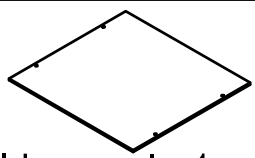
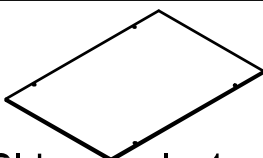
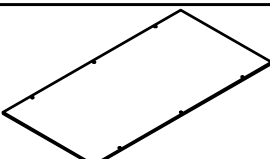
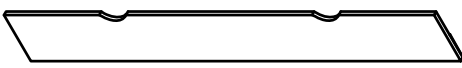

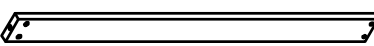
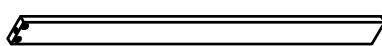
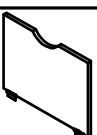
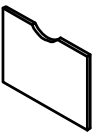



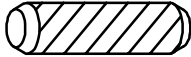
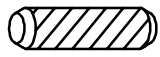

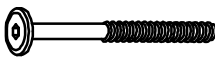



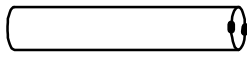

# PartList

<b>A</b>  CapforHB-2pcs	<b>A1</b>  LegHB-2pcs	<b>A2</b>  LegHB-2pcs
<b>A3</b>  Horizontalbar-8pcs	<b>A4</b>  Horizontalbar-6pcs	
<b>B</b>  UpperHB-1pc	<b>B1</b>  LegHB(FRONT)-1pc	<b>B2</b>  LegHB(BACK)-1pc
<b>B3</b>  Horizontalbar-6pcs	<b>B4</b>  Sidepanel-2pcs	<b>B5</b>  Horizontalbar-1pc
<b>B6</b>  Sidepanel-2pcs	<b>B7</b>  Horizontalbar-1pc	<b>B8</b>  Sidepanel-2pcs
<b>B9</b>  Horizontalbar-1pc	<b>B10</b>  Sidepanel-2pcs	<b>B11</b>  Horizontalbar-2pcs
<b>C</b>  UpperFB-1pc	<b>C1</b>  Horizontalbar-1pc	<b>C2</b>  Horizontalbar-1pc
<b>C3</b>  Horizontalbar-1pc	<b>C4</b>  LegFB(FRONT)-1pc	<b>C5</b>  LegFB(BACK)-1pc
<b>D</b>  Siderail(upper)-2pcs	<b>E</b>  Siderail(Lower)-2pcs	<b>F</b>  Longguardrail-4pcs
<b>G</b>  Verticalguardrail-2pcs		

# Part List

<p><b>H</b></p>  <p>Slats (30pcs)</p>	<p><b>I</b></p>  <p>Horizontal bar - 2pcs</p>	<p><b>J</b></p>  <p>Back panel - 2pcs</p>
<p><b>K</b></p>  <p>Side panel - 1pc</p>	<p><b>L</b></p>  <p>Side panel - 2pcs</p>	<p><b>M</b></p>  <p>Side panel - 1pc</p>
<p><b>N</b></p>  <p>Horizontal bar - 1pc</p>	<p><b>O</b></p>  <p>Side panel - 1pc</p>	<p><b>P</b></p>  <p>Side panel - 1pc</p>
<p><b>Q</b></p>  <p>Side panel - 1pc</p>	<p><b>R</b></p>  <p>Front panel - 1pc</p>	<p><b>S</b></p>  <p>Back panel - 1pc</p>
<p><b>T</b></p>  <p>Left side panel -1pc</p>	<p><b>U</b></p>  <p>Right side panel -1pc</p>	<p><b>V</b></p>  <p>Side panel - 1pc</p>
<p><b>W</b></p>  <p>Side panel - 1pc</p>		

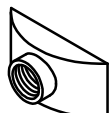
# Hardware List

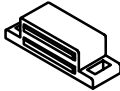
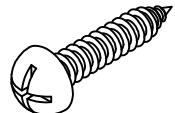

1		2		3	
	Wood dowel Ø10x40 (16pcs)		Wood dowel Ø8x30 (8pcs)		Screws 1/4" x80 (32pcs)
4		5		6	
	Bolts 1/4" x75 (32pcs)		Bolts 1/4" x30 (16pcs)		Bolts 1/4" x25 (6pcs)
7		8		9	
	Screws M4x30 (74pcs)		1/4" x15 mm T-nut (6pcs)		1/4" x15 Cross nuts(16pcs)
10		11		12	
	Wood dowel Ø12x70(4pcs)		Bolts 1/4" x60 (5pcs)		Screw M4x15 (14pcs)
13		14		15	
	Pan head Screw M4x15 (13pcs)		Caster (4pcs)		Screw M4x20 (8pcs)
16		17		18	
	Allen key (1pc)		Screws 1/4" x60 (4pcs)		1/4" Half Moon 16pcs
19		20		21	
	Screw M3.5x12 (18pcs)		Door Catches 45*17*13(6pcs)		Screw M4x20 (12pcs)

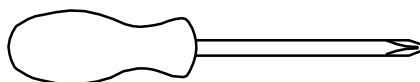
## ASSEMBLY TOOLS REQUIRED ( NOT INCLUDED )

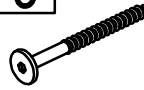

PLEASE BE CAREFUL DO NOT DAMAGE THE HOLE POSITION WHEN YOU USE POWER TOOLS !

**STEP1:**

3	16
	
16PCS	1 PC

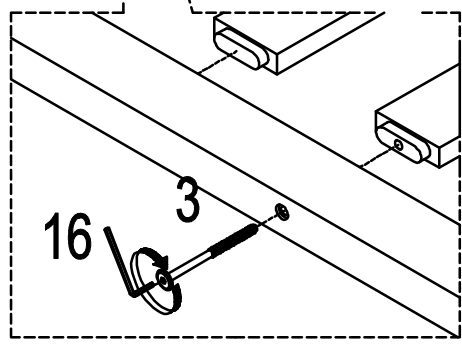
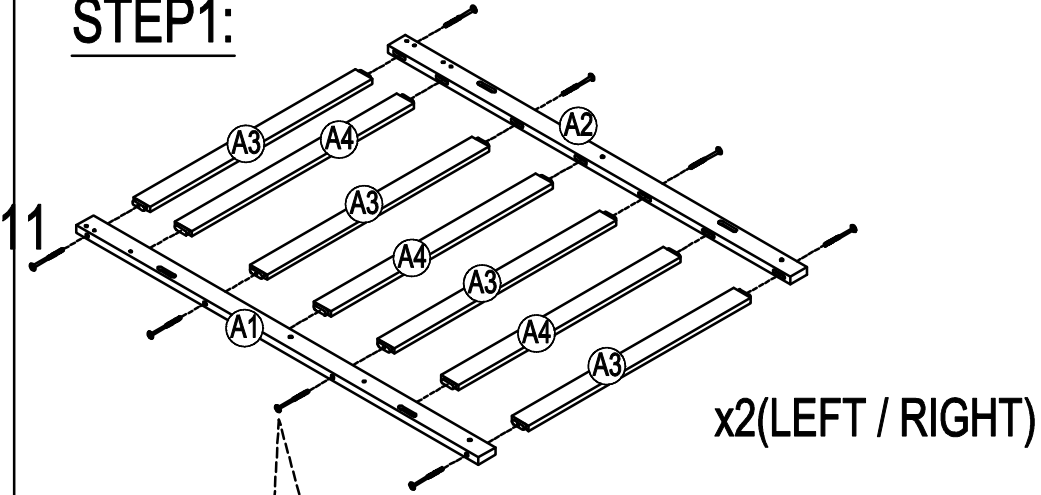

**STEP2:**

7

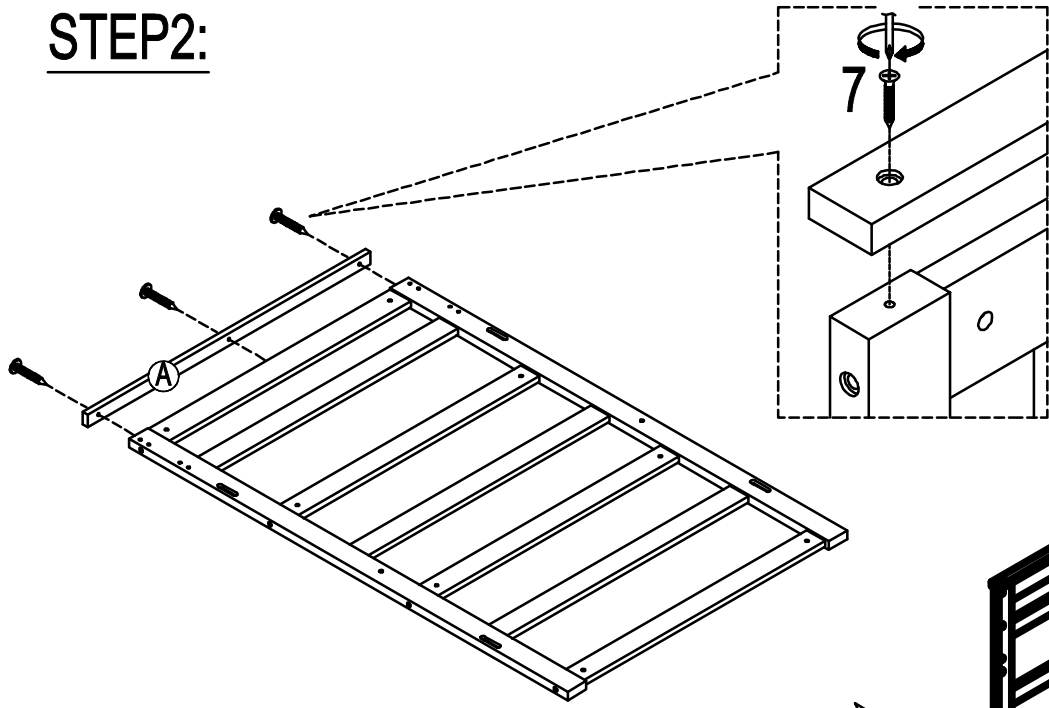
6PCS

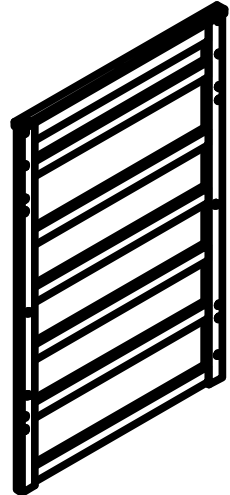

THE OTHER SIDE →



x2(LEFT / RIGHT) 06/14

### STEP 3:

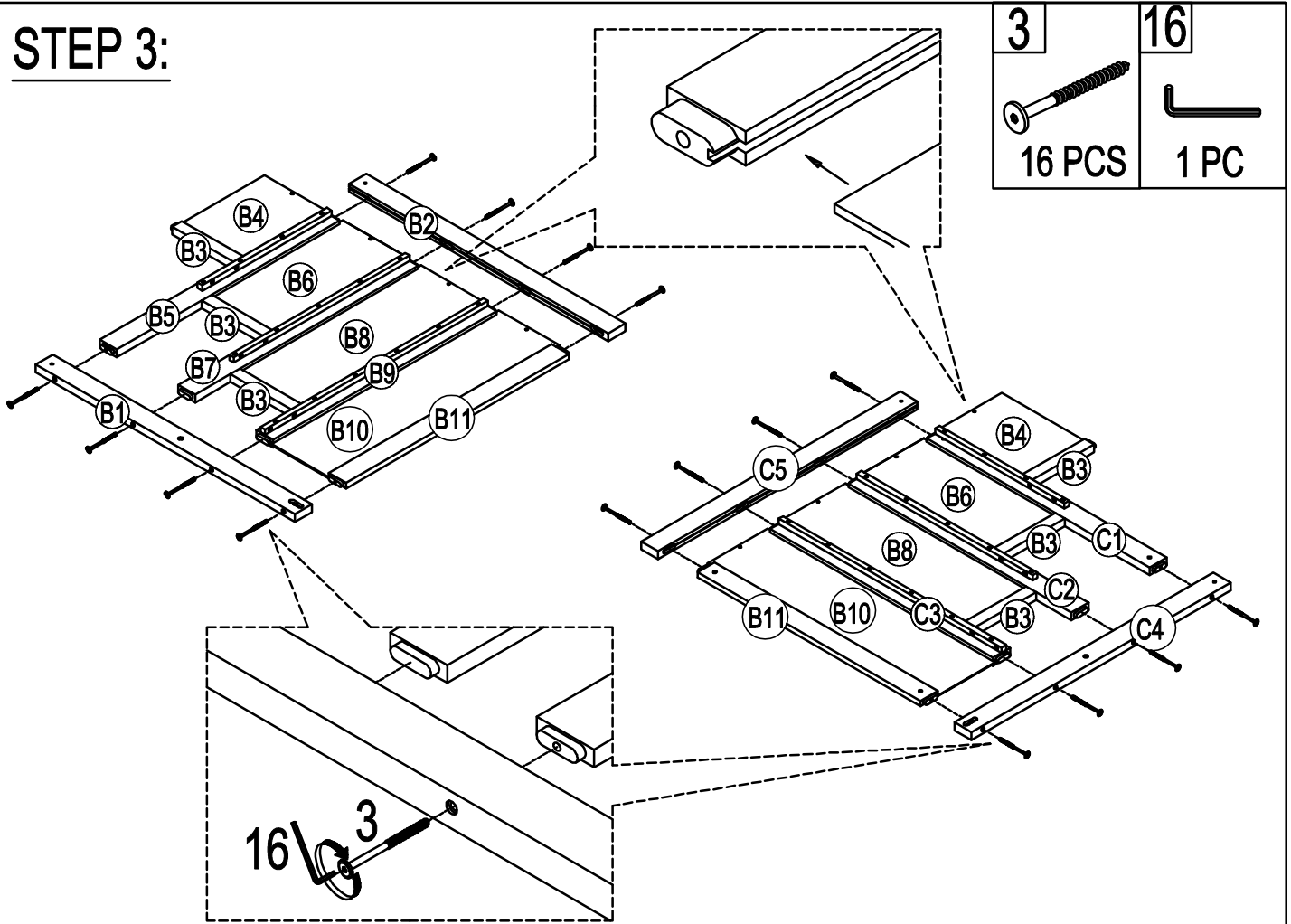

### STEP 4:

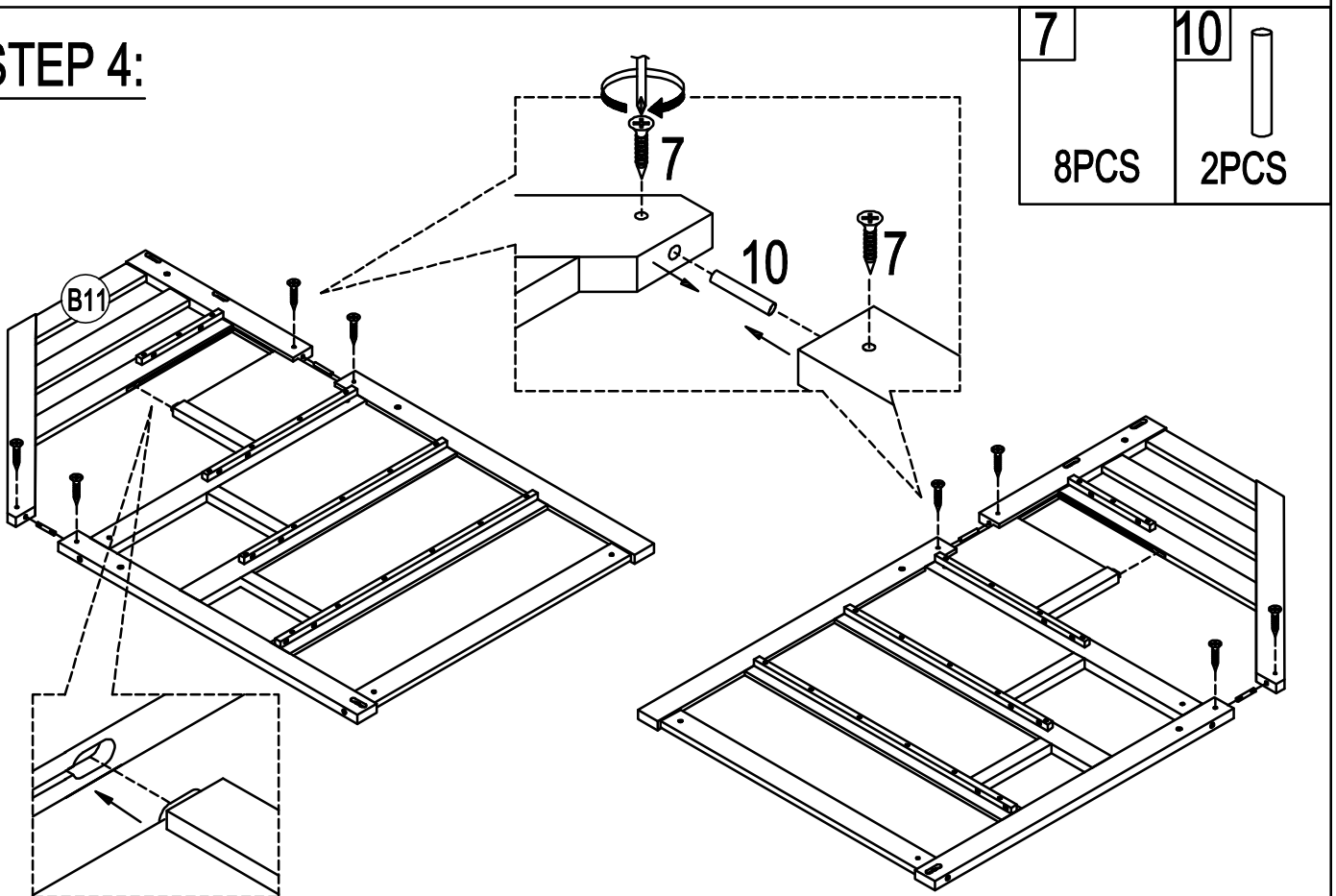

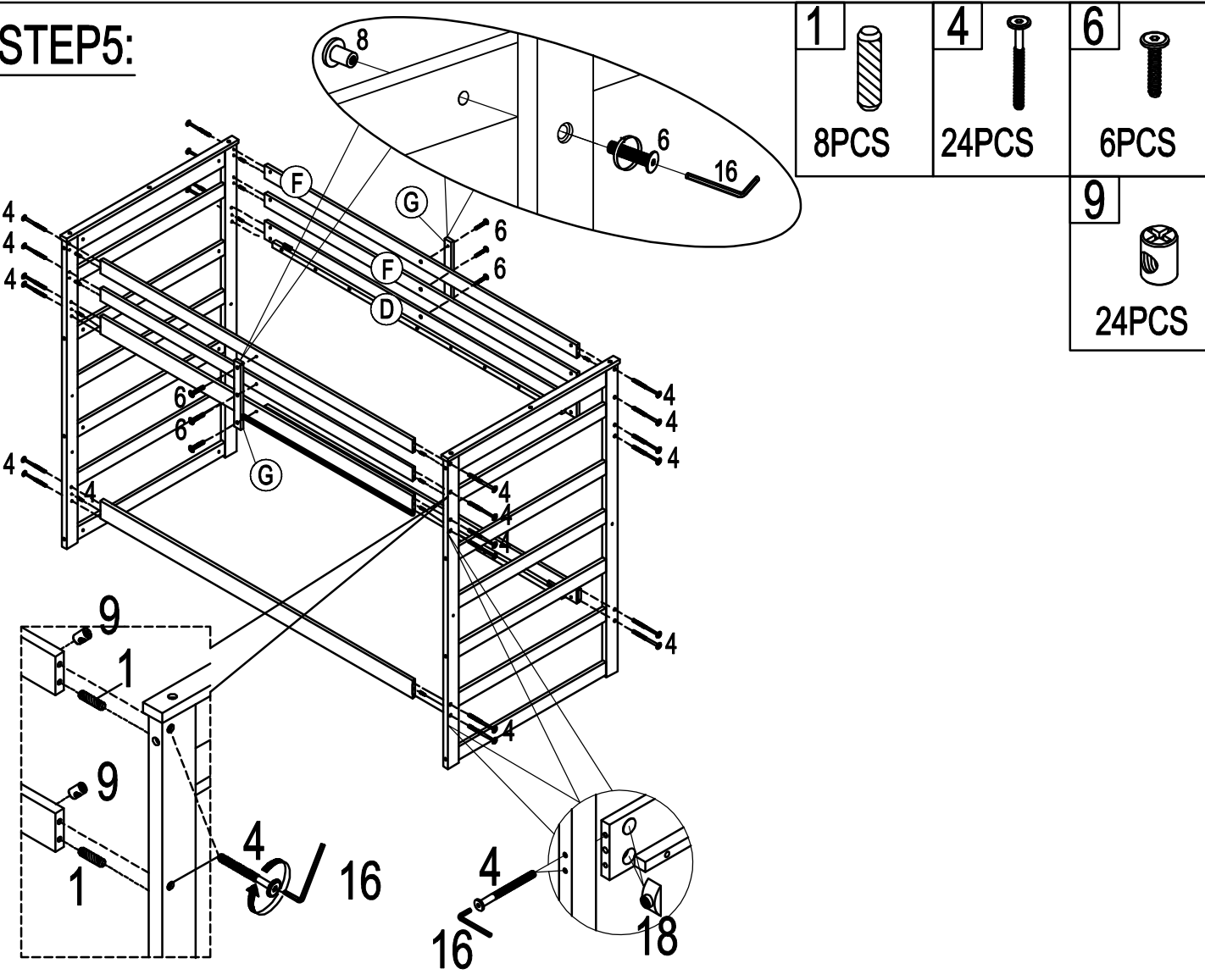

# STEP5:

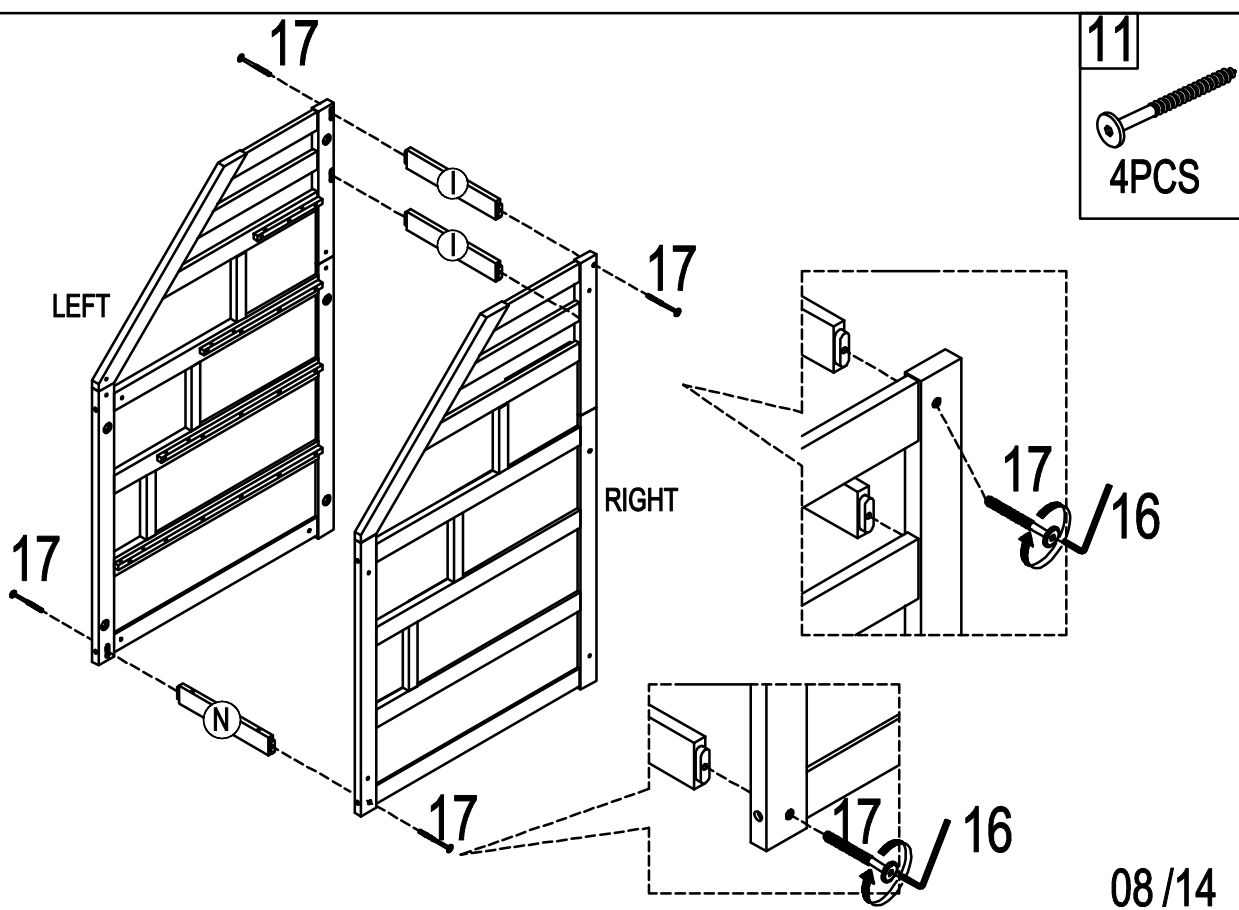

# STEP6:



# STEP 7:

2		5	
4PCS		4PCS	

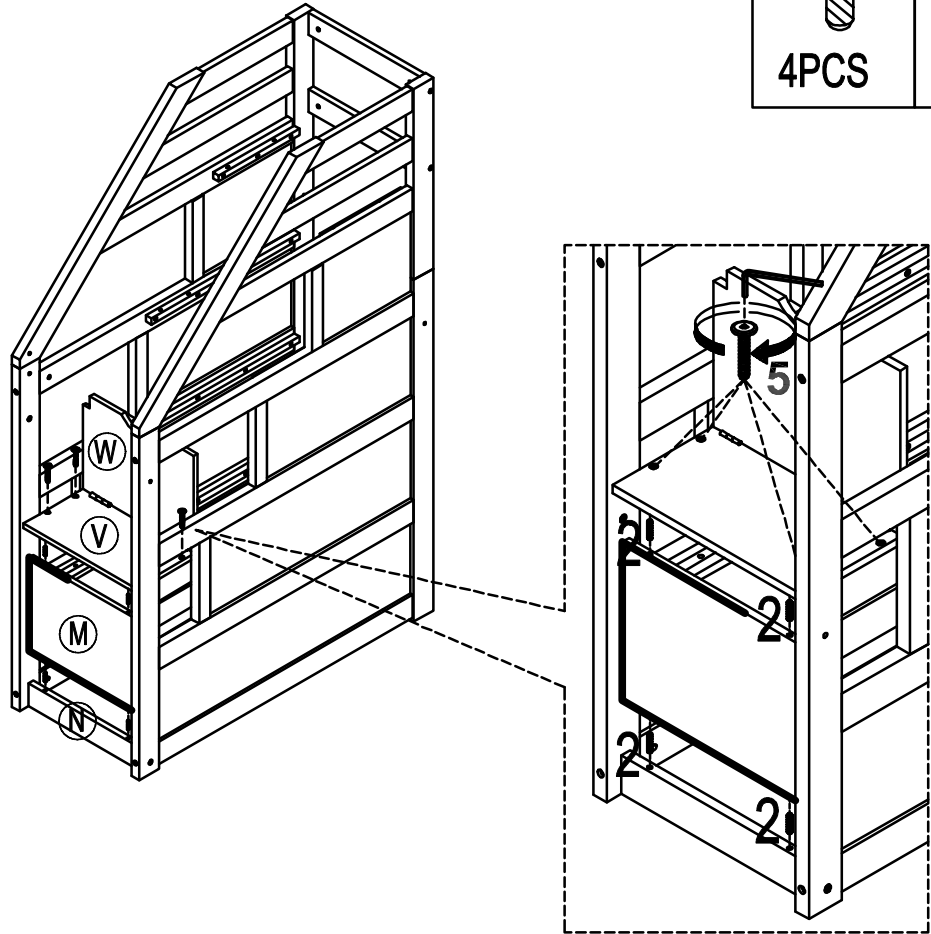

# STEP 8:

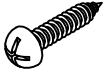
20		21	
6 PCS		12 PCS	

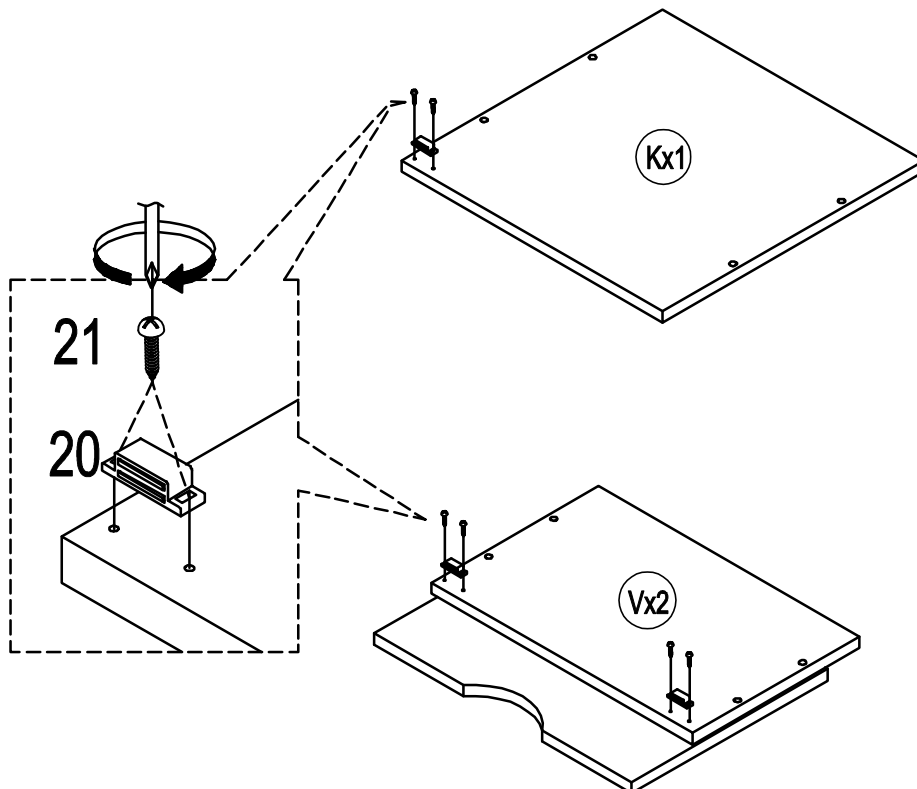

# STEP 9:

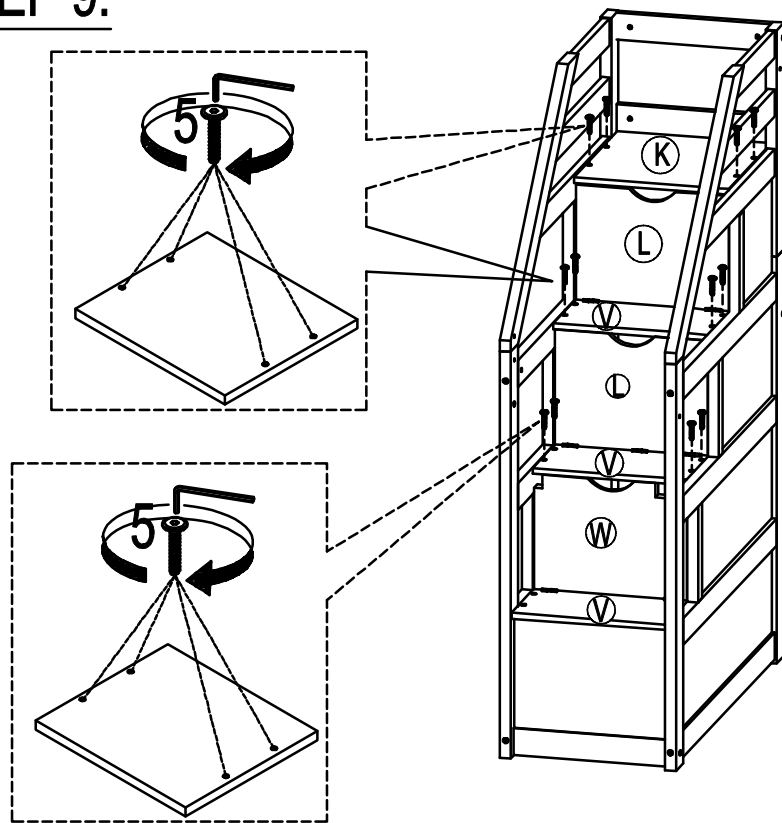

5



12PCS

# STEP 10:

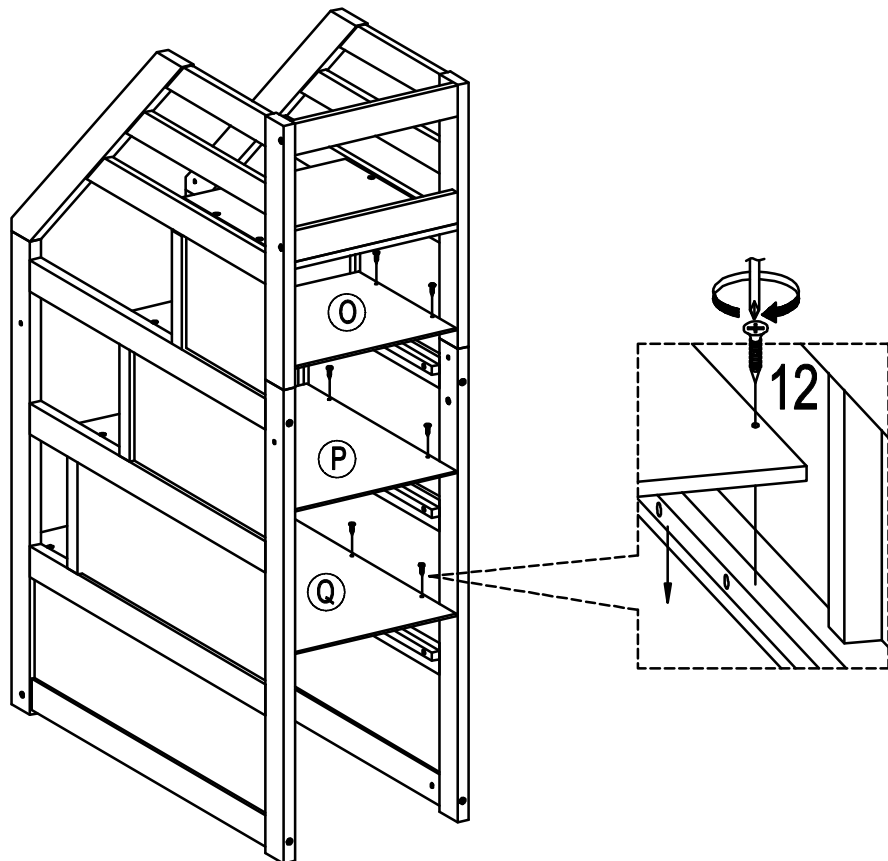



12



14PCS

**STEP11:**

17		11	
2PCS		2PCS	

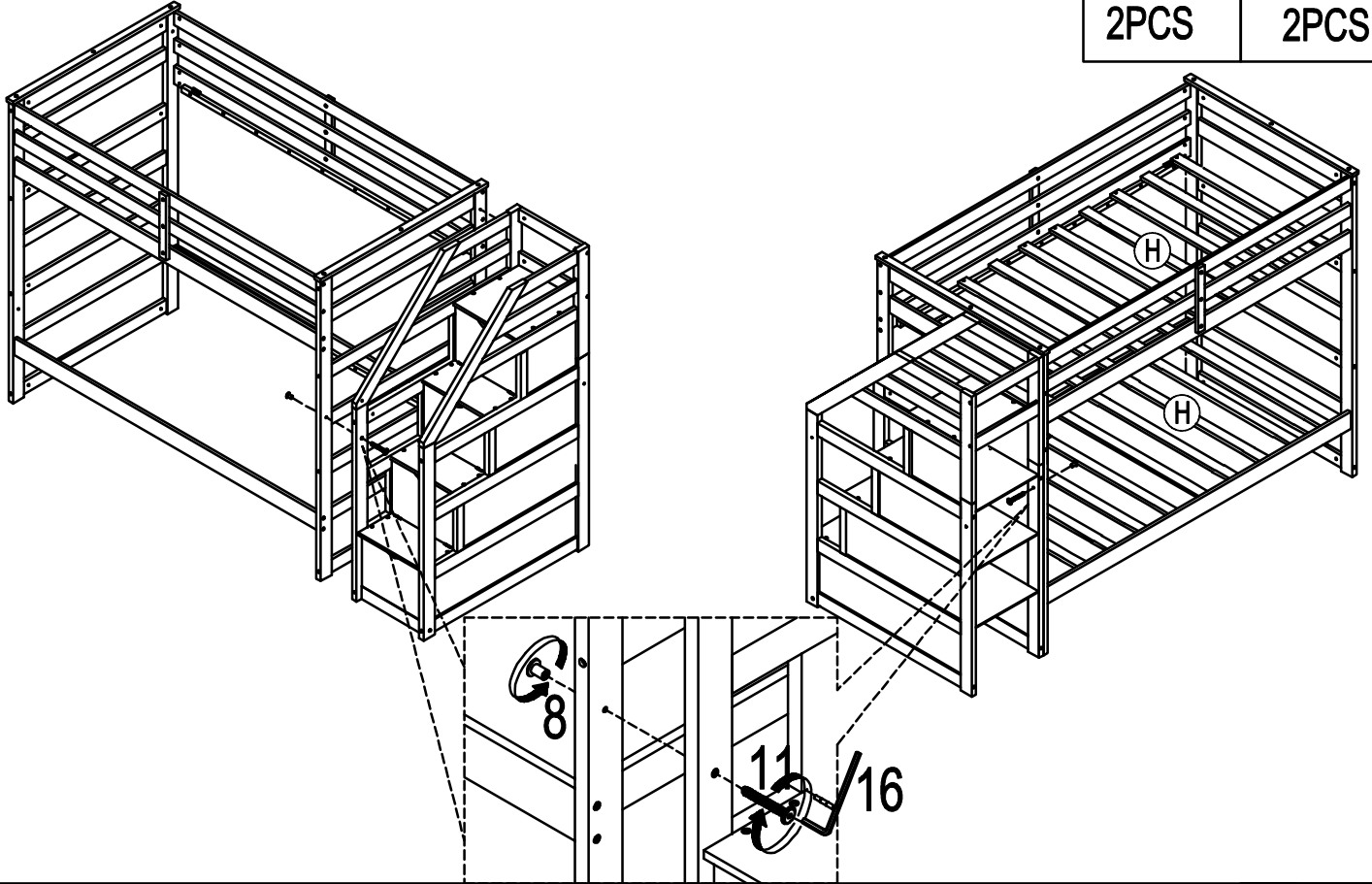

**STEP12:**

13	
12PCS	

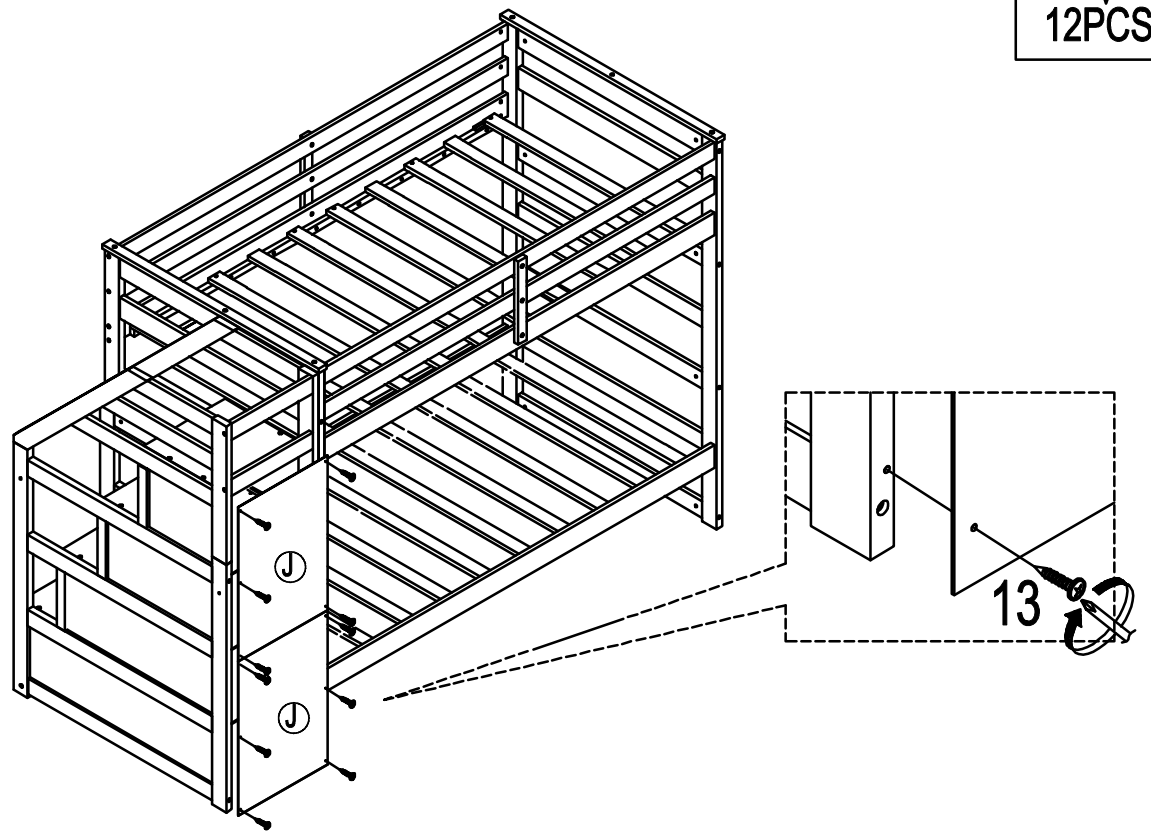

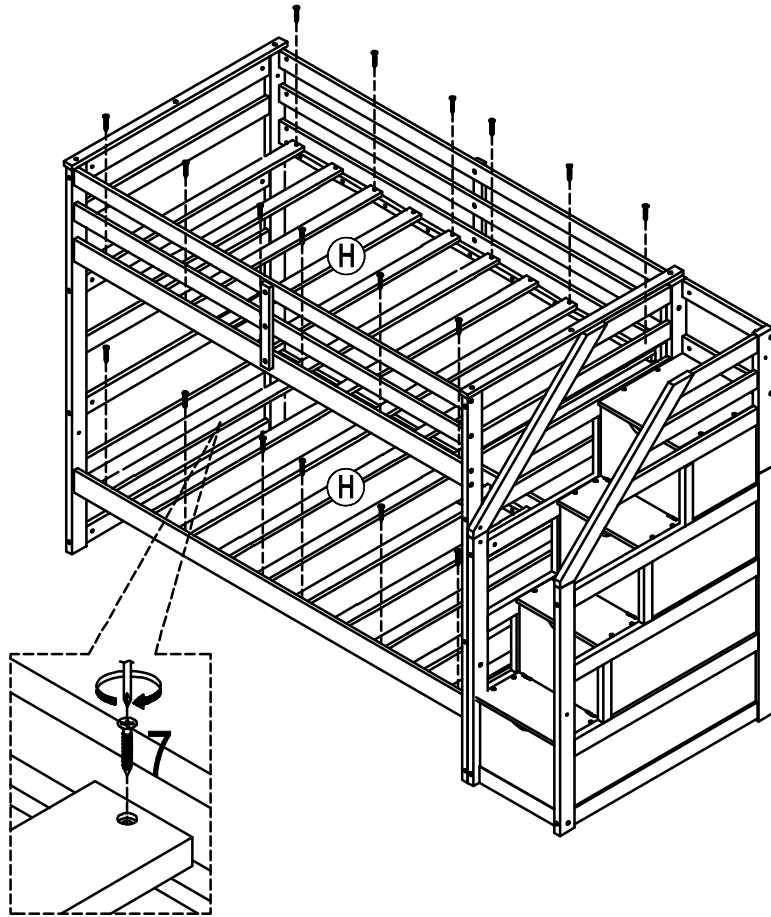

**STEP13:**

**11**  
  
**40PCS**



**STEP14:**

**15**  
  
**8PCS**

**14**  
  
**4PCS**

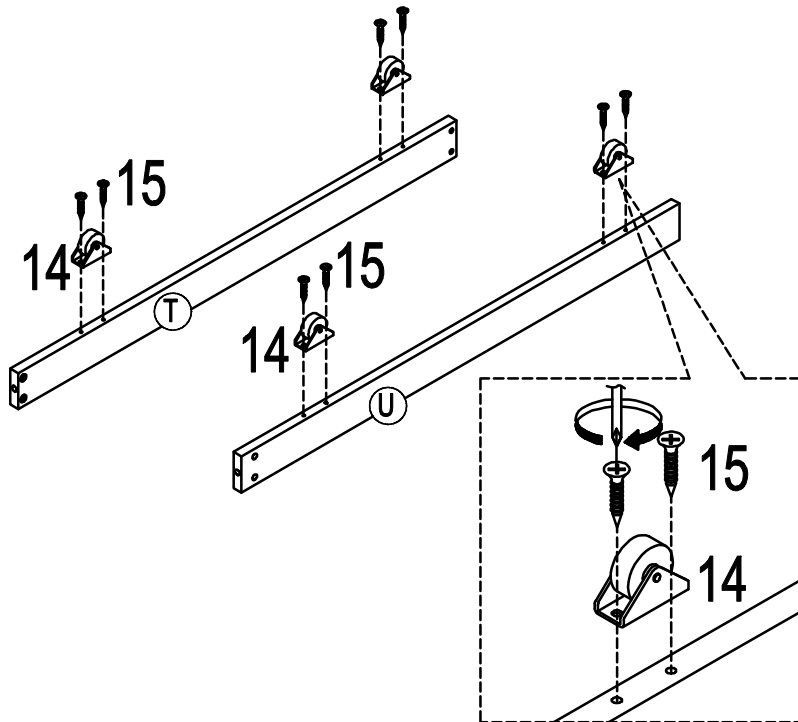

# STEP15:

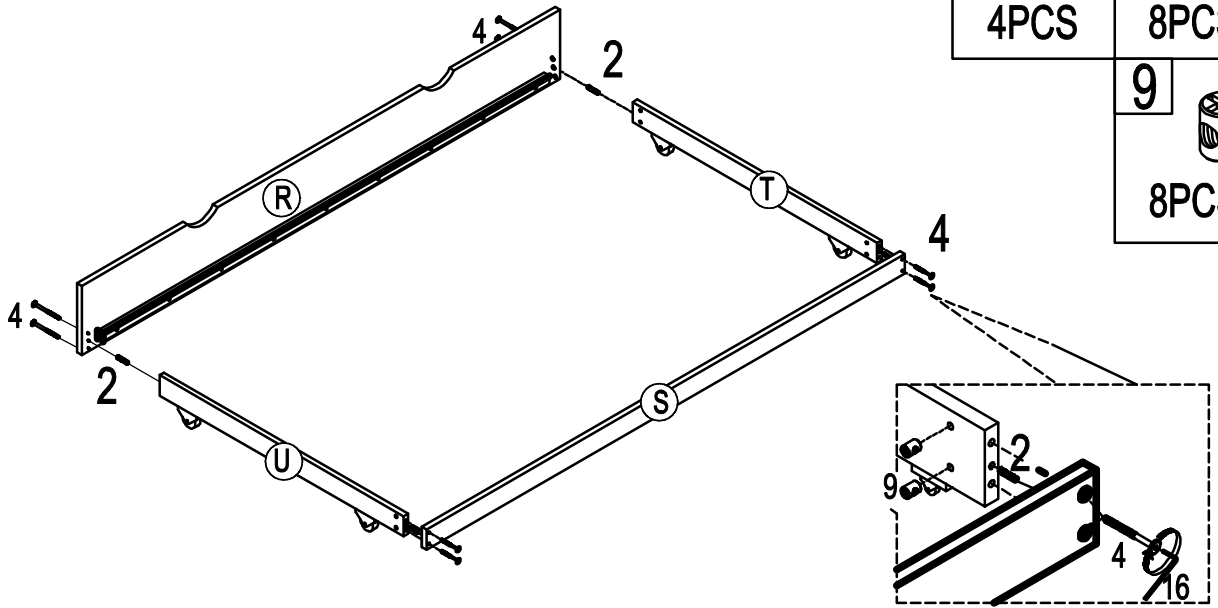

# STEP16:

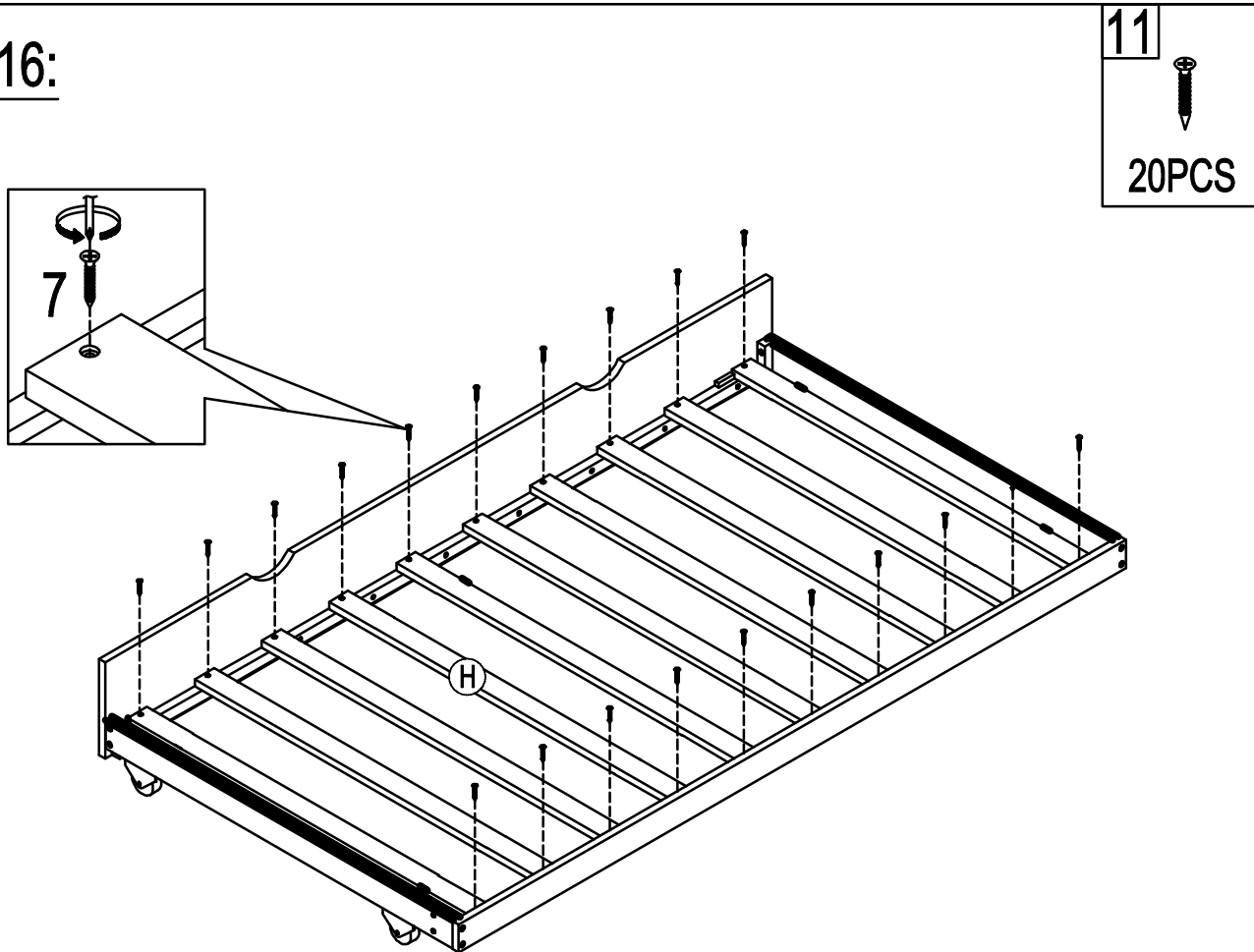

**STEP17:**

