

Swivel Chair

Assembly Guide



IMPORTANT: please read these instructions fully before starting assembly



**SAFETY AND
CARE ADVICE**



NO POWER TOOLS

- Check you have all the components and tools listed
- Remove all fittings from their bags and separate into groups
- We do not recommend use of power tools - this could damage the unit. Only use hand screwdrivers and Allen keys
- Keep children and animals away from the work area, small parts could cause choking if swallowed
- Make sure you have enough space to lay out the parts before starting
- Assemble the item as close to its final position (same room) as possible
- Do not over tighten the nuts to avoid damage to the threads
- Only clean using a damp cloth and mild detergent. Do not use bleach or abrasive cleaners
- Do not allow children to climb or play on this product
- From time to time, check there are no loose screws in this unit
- This product should not be discarded with household waste. Take to your local authority waste disposal centre
- Unless otherwise stated, this product is designed for domestic use and is not certified for commercial or contract settings.

IMPORTANT INFORMATION



20 Minute
Build





Two Person
Build





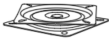





Max Weight
Capacity
120kg

Note: Assembly estimates are approximate and can differ based on the specific environment and user experience.

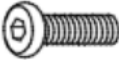
Label	Part Name	Drawing	Quantity
1	Chair Seat		1
2	Upper Swivel Plate		1
3	Center Support Base		1
4	Leg Bracket		4

WHAT'S IN THE BOX

Note: the quantities are the correct amount to complete the assembly. In some cases more fixings may be supplied than are required.

Label	Part Name	Drawing	Size (mm)	Quantity
A	Allen Screw		M8 x 10	12
B	Nut		M6	4
C	Allen Screw		M6 x 20	8
D	Flat Washer		Ø18 x Ø6	12
E	Allen Key		5	1
F	Allen Key		6	1
G	Spanner		M6	1
H	Spring Washer		M6	8

Please note, the fixings above are for a single chair.

Note:

- Use a clear, flat surface to avoid bumps or scratches before assembling.
- Insert all fixings loosely at first to allow for alignment; only tighten them once everything is properly positioned, as some adjustment may be required.
- Avoid over-tightening, as this may damage the parts.
- Seek assistance when moving large or heavy parts

STEP 1

Carefully align the 4x leg brackets [4] to the center support base [3] and secure using 4x screws [A].

To allow for alignment, partially tighten the fixings with Allen key [F]

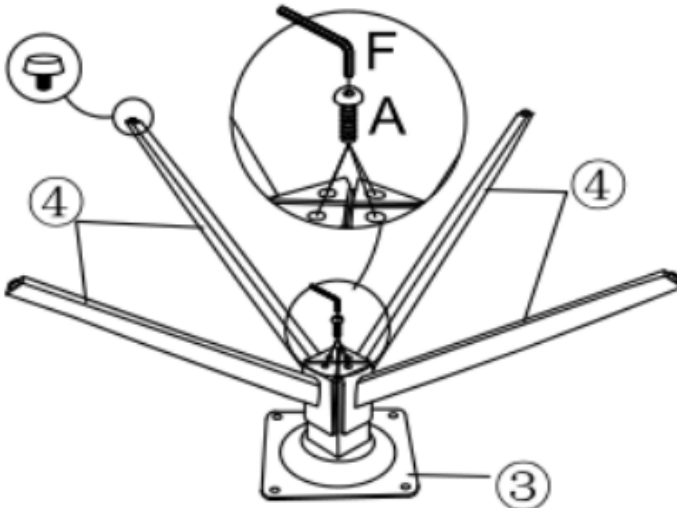

NOTE: Insert ALL screws loosely, only fully tighten when instructed to do so. In the event of miss-alignment or chair wobbling, please untighten screws, realign and re-tighten.

STEP 2

Secure the upper section of each leg [4] to the central hub using 8x screws [A]

To allow for alignment, partially tighten the fixings with Allen key [F]

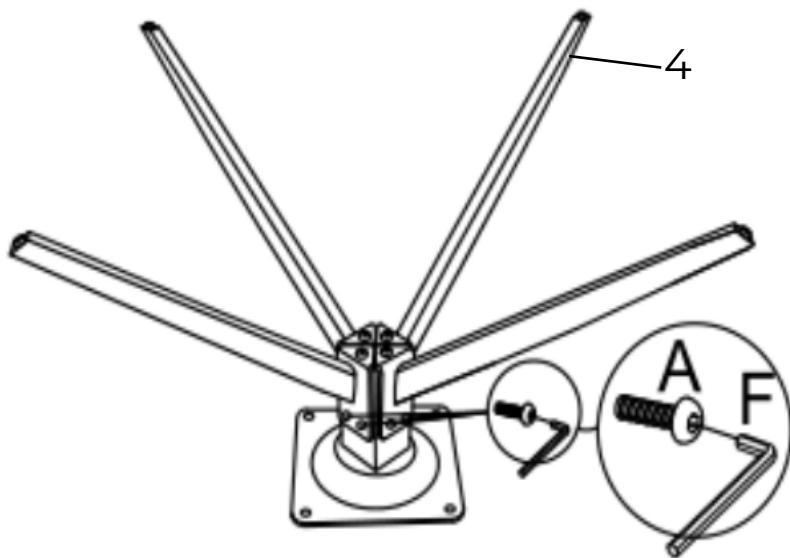

NOTE: Insert ALL screws loosely, only fully tighten when instructed to do so. In the event of miss-alignment or chair wobbling, please untighten screws, realign and re-tighten.

STEP 3

Flip the base over so it stands on all four legs. Ensure all plastic feet are flat on the ground.

Fully tighten ALL screws with Allen key [F] to stabilize the base.

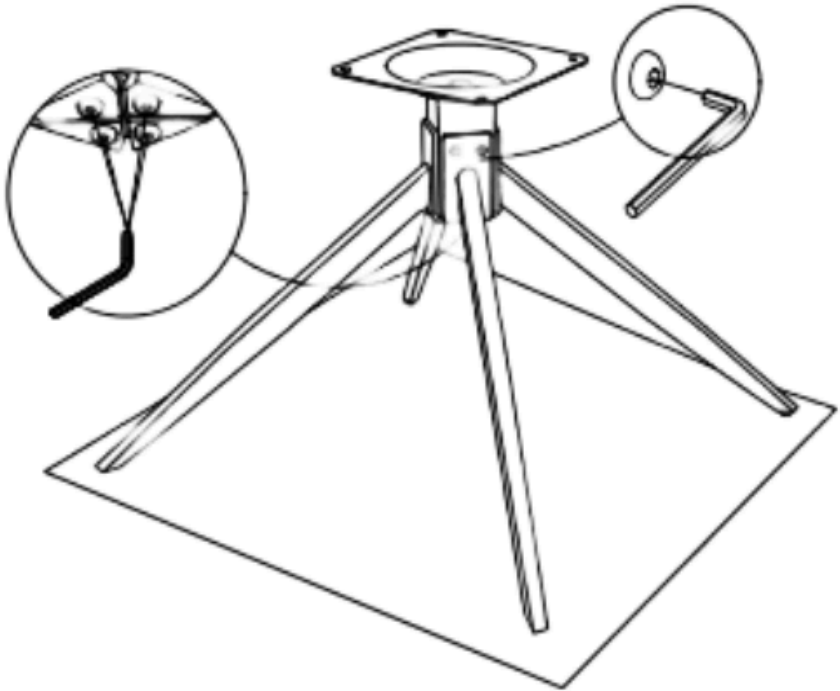

STEP 4

Attach the upper swivel plate [2] to the top of the base using 4x screws [C], 4x spring washers [H], 4x flat washers [D], and 4x nuts [B].

Use Allen key [E] and spanner [G] to secure firmly.

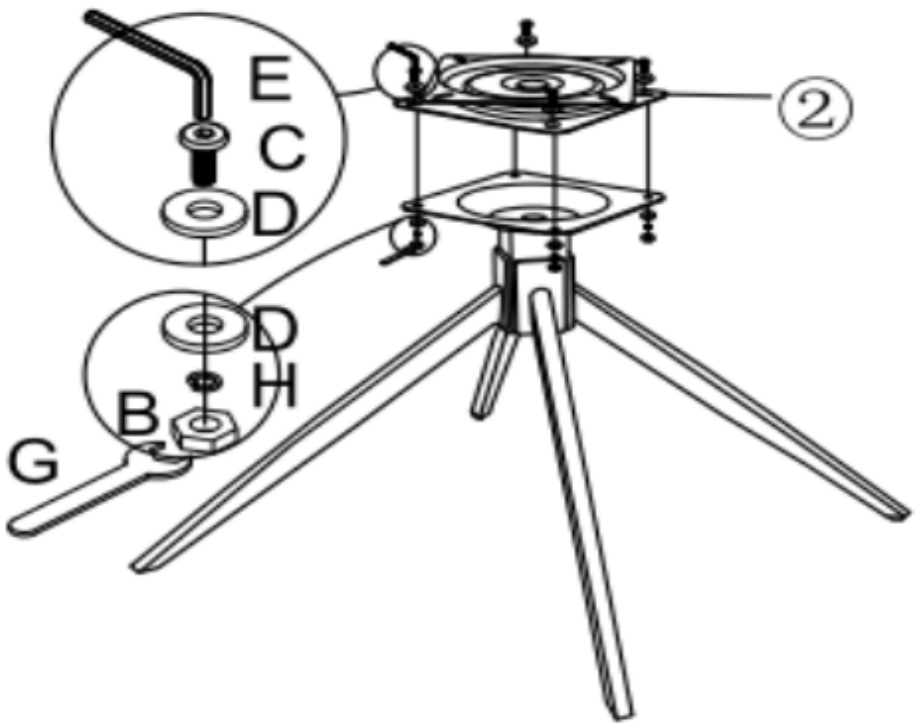

STEP 5

Place the swivel base onto the chair seat [1].

Secure using 4x washers [D], 4x spring washers [H] and 4x screws [C],

Tighten all screws using Allen key [E].

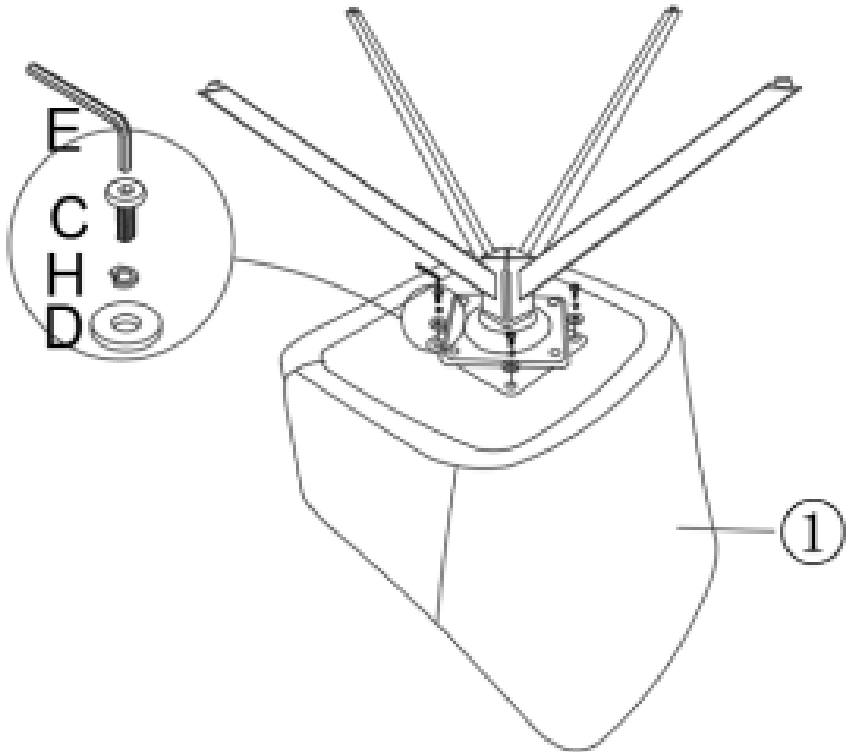

STEP 6

Carefully and with help, flip the chair onto the legs.
Check the stability

NOTE: In the event of miss-alignment or chair wobbling, please untighten screws, realign and re-tighten.



STEP 7

Your Chair is now ready to use!

STEP 8

Repeat the assembly process for any subsequent chairs.

Please ensure any and all fixings and fittings are FULLY tightened before using this product



our 2 year GUARANTEE

Our products come with a 2 year guarantee, giving you extra peace of mind when shopping with us!

What the guarantee covers



PRE-INSERTED FIXINGS
e.g. loose metal threads



FAULTY JOINTS
e.g. legs bending



EXTERNAL FIXING FAULTS
e.g. metal discs removing
from table top



STRUCTURAL INTEGRITY
e.g. the frame of the
product
