

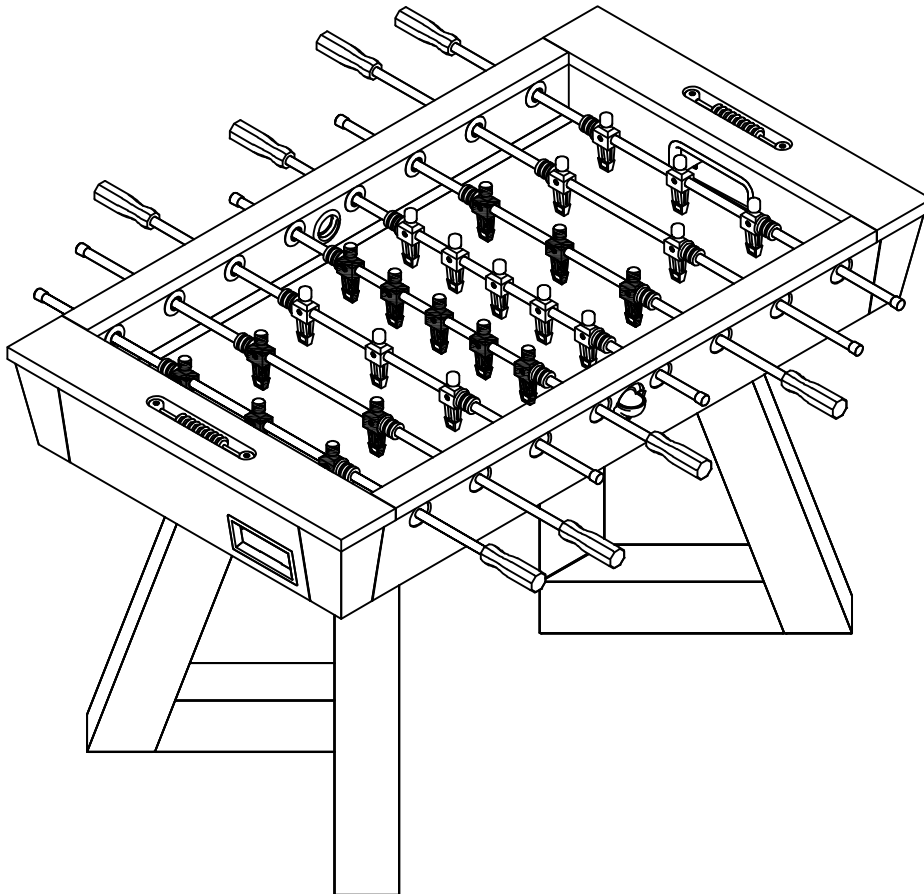



Aris Foosball Table Assembly Instruction





Congratulations!
We hope you will have many hours of enjoyable use with your new Foosball Table!

	<p>Warning Adult Assembly Required Asamblea de adultos de advertencia necesaria</p>
---	--

	<p>PLEASE KEEP YOUR INSTRUCTIONS!</p> <ul style="list-style-type: none">· Your Model number is necessary should you need to contact us.· Please read through this instruction book to familiarize yourself with all the parts and assembly steps.· Refer to the Parts Identifier and verify that all parts have been included.
---	---



WARNING!

This is not a child's toy. Adult supervision is required for children playing this game. Please read instructions carefully. Proper use of this set can avoid damage or injury.



BEFORE ASSEMBLY:

- Did you receive 1 box?
- Did you inspect your playfield/main table frame before assembly? It is not replaceable and must be returned to the original place of purchase if damaged.



TOOLS REQUIRED FOR ASSEMBLY:

- Phillips and Slotted Head Screwdrivers /or Power Driver (not included)
- Allen Wrench (included)

ASSEMBLY INSTRUCTIONS:



We recommend that two adults work together to assemble this table.

- The table will be assembled upside down This is a very heavy table and turning it right side up will require at least two strong adults.
- We suggest that you use the bottom carton as a clean flat work area to protect the top of your Air hockey table while assembling.

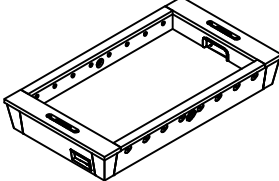
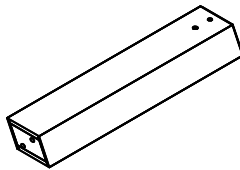
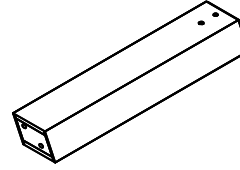
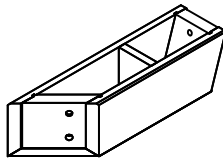
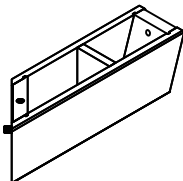
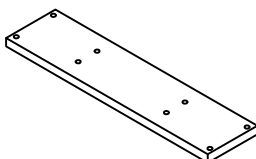
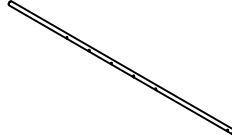
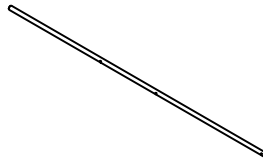
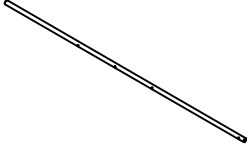

Aris Foosball Table Assembly Instruction

Parts List

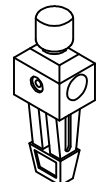
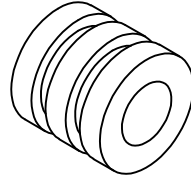
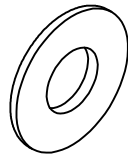
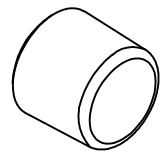
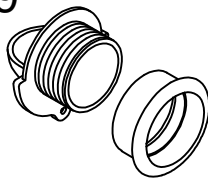
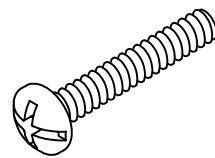
<p>A</p>  <p>Main Frame x1</p>	<p>B</p>  <p>Leg-A x2</p>	<p>C</p>  <p>Leg-B x2</p>	<p>D</p>  <p>End Panel-A x2</p>
<p>E</p>  <p>End Panel-B x2</p>	<p>F</p>  <p>Leg Connection Plate x2</p>	<p>#1</p>  <p>Player Rod-5 x2</p>	<p>#2</p>  <p>Player Rod-2 x2</p>
<p>#3</p>  <p>Player Rod-3 x4</p>	<p>#4</p>  <p>Player-Black x13</p>	<p>#5</p>  <p>Player-Gray x13</p>	<p>#6</p>  <p>Bumper-Rubber x16</p>
<p>#7</p>  <p>Washer ϕ36mm x16</p>	<p>#8</p>  <p>Player Rod Cap x8</p>	<p>#9</p>  <p>Ball-Entry Cup-Outside x2</p>	<p>#10</p>  <p>Bolt ϕ5/32"x1" x26</p>



Aris Foosball Table Assembly Instruction

Parts List

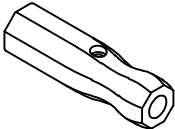
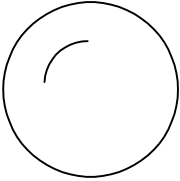
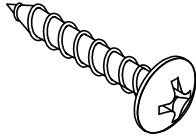
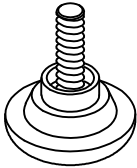
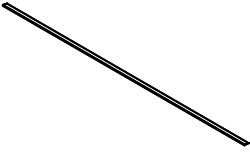
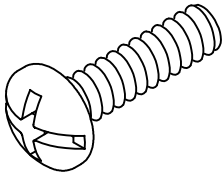
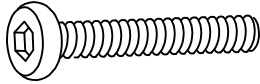
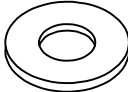
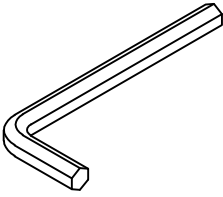
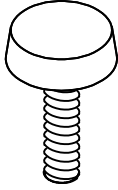
<p>#11</p>  <p>Nut $\phi 5/32$"x9x6mm x26</p>	<p>#12</p>  <p>Handle x8</p>	<p>#13</p>  <p>Football x4</p>	<p>#14</p>  <p>Screw 8#x5/8" x2</p>
<p>#15</p>  <p>Leg Leveler $\phi 5/16$" x4</p>	<p>#16</p>  <p>Playfield Trim x2</p>	<p>#17</p>  <p>Bolt $\phi 3/16$"x5/8" x8</p>	<p>#18</p>  <p>Bolt $\phi 5/16$"x2" x26</p>
<p>#19</p>  <p>Washer $\phi 5/16$"x$\phi 19$mm x26</p>	<p>#20</p>  <p>Allen Wrench 5mm x1</p>	<p>#21</p>  <p>Leg Leveler $\phi 1/4$" x2</p>	



Aris Foosball Table Assembly Instruction

Step 1:

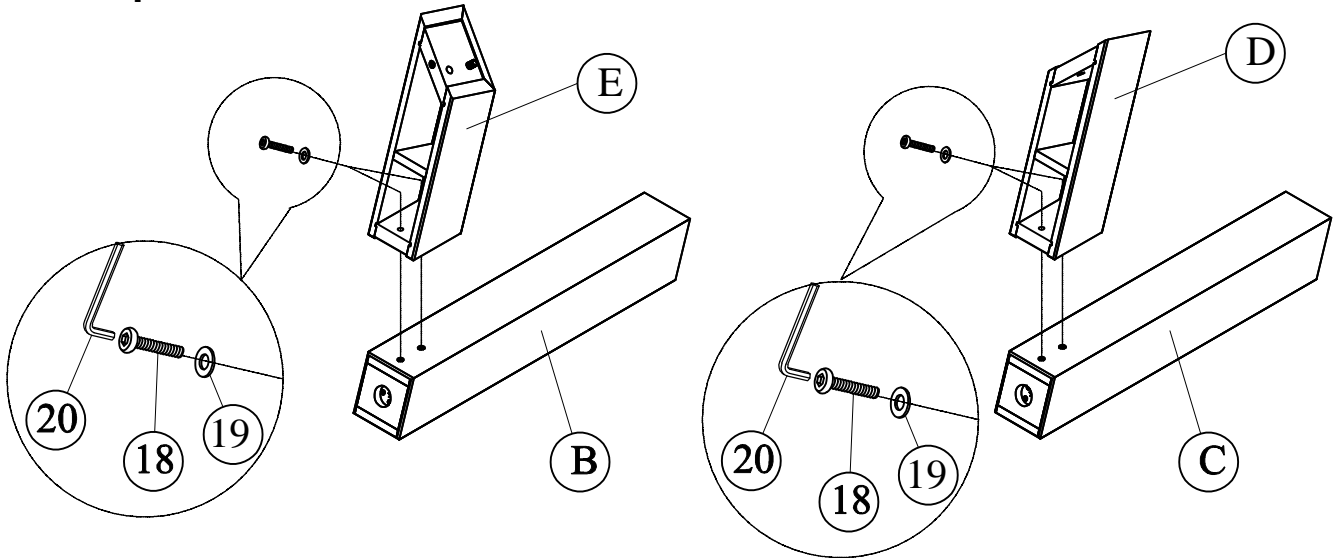

Step 2:

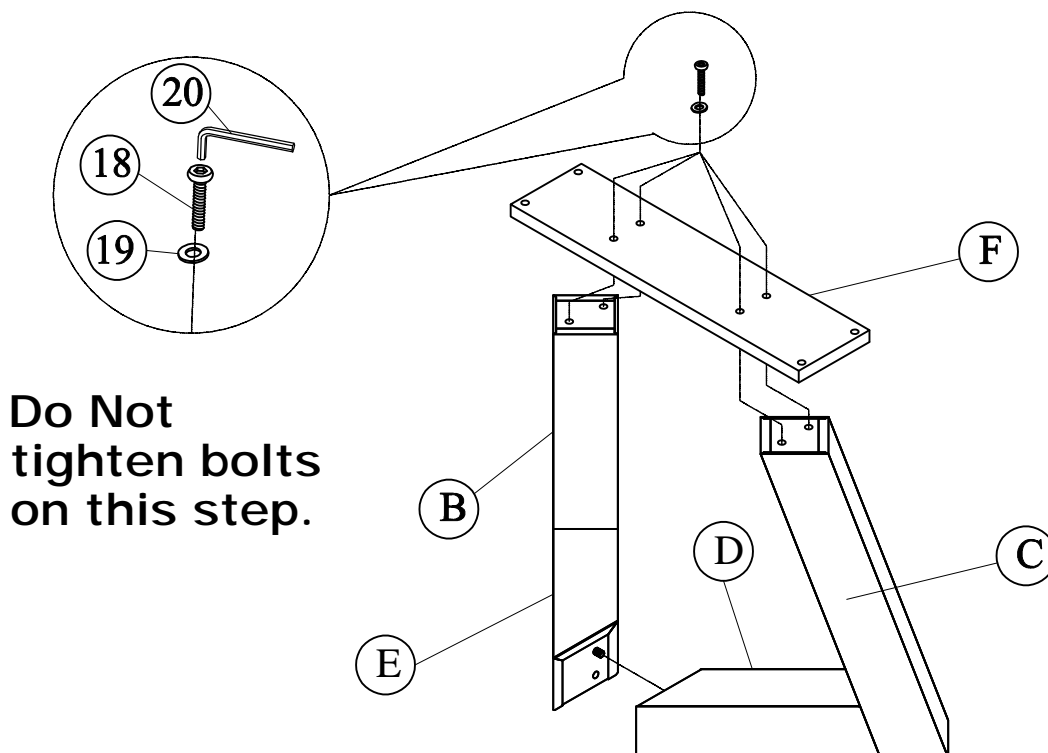



Aris Foosball Table Assembly Instruction

Step 3:

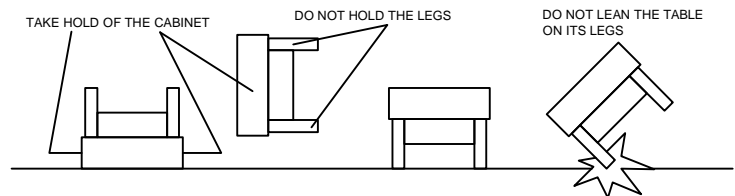
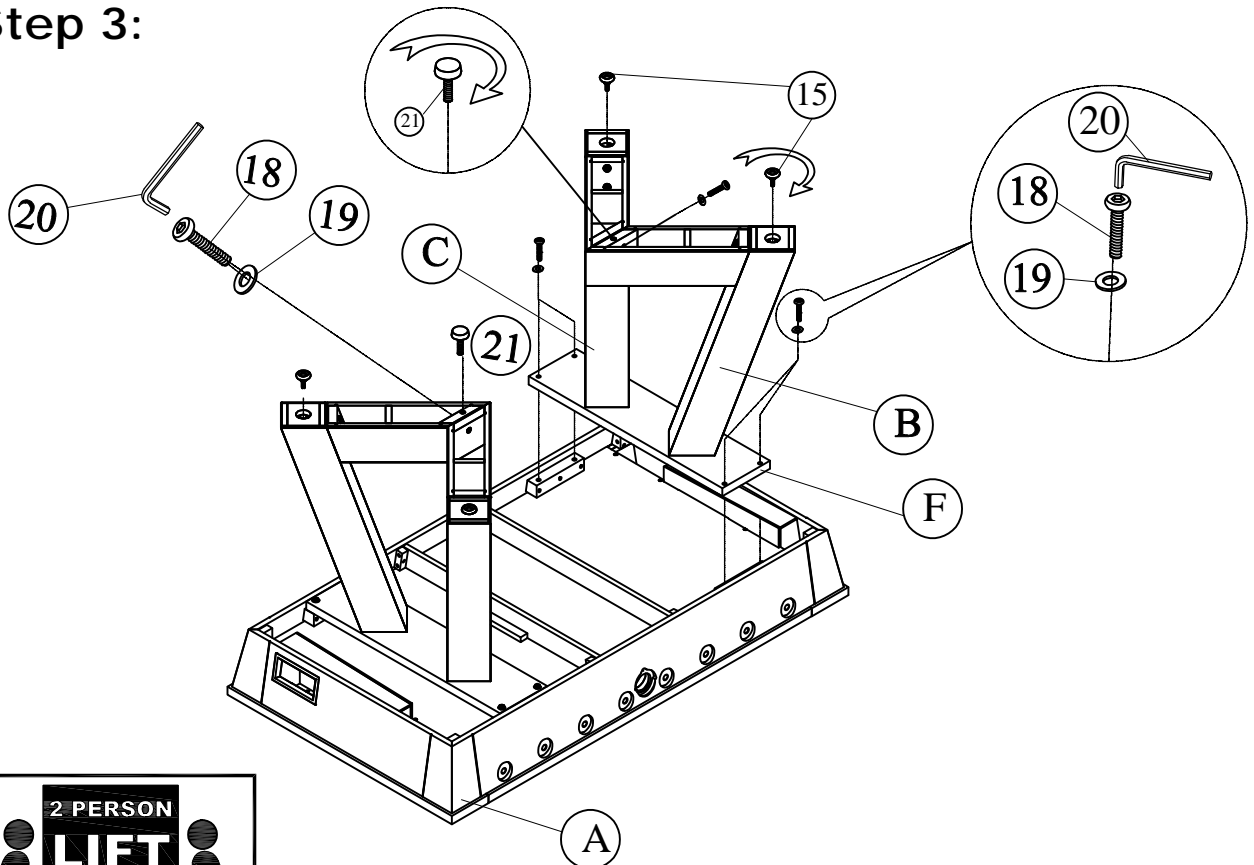

Step 4:

Tighten all bolts on legs assembly.

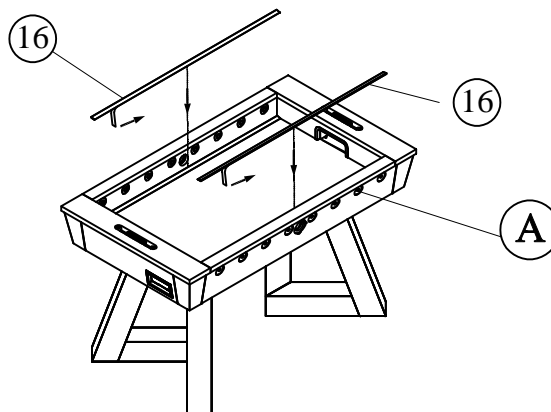



Aris Foosball Table Assembly Instruction

Step 5:

Note: set the rods into the right position according to the artwork.

The players of each team should be right-side up, facing their opponent's goal, follow the diagram below for proper rod placement

Slide one end of the player rods (#1, #2, #3) through the main cabinet according to the diagram below to identify where the two, three, and five player rods go in the cabinet.

Player rod assembly:

Place one #6 bumper & one #7 washer on the rod

Place the appropriate number of Attach #4 and #5 players to the rod #1 and #rod2 rod #3.

Using #10 bolt and #11 nut Place one #7 washer & one #6 bumper on the other end of rod. Slide the rods through the other end of the cabinet

Repeat the process for each rod

Note: The Rods have a hole at the end where their Handles will go.

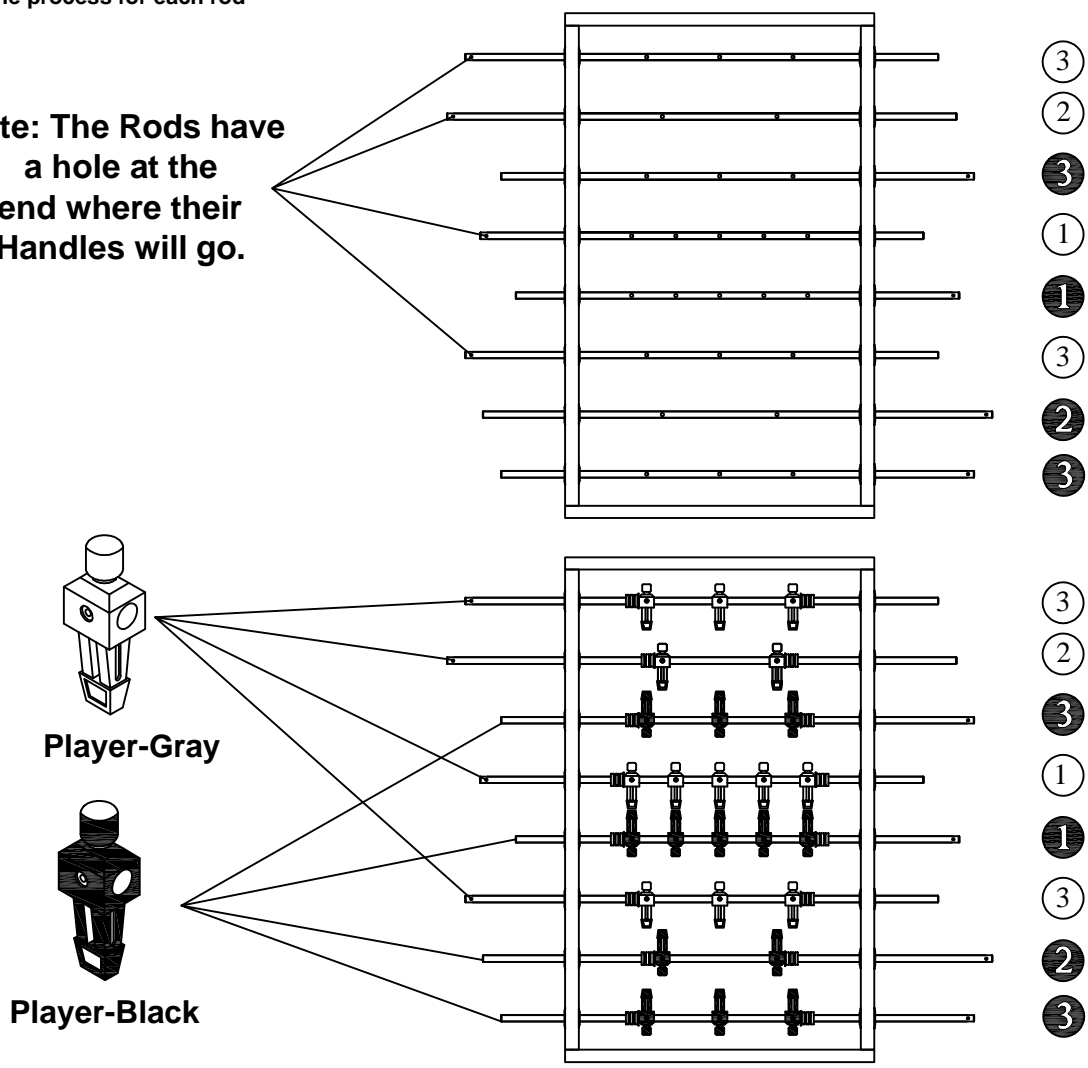



Aris Foosball Table Assembly Instruction

Step 6:

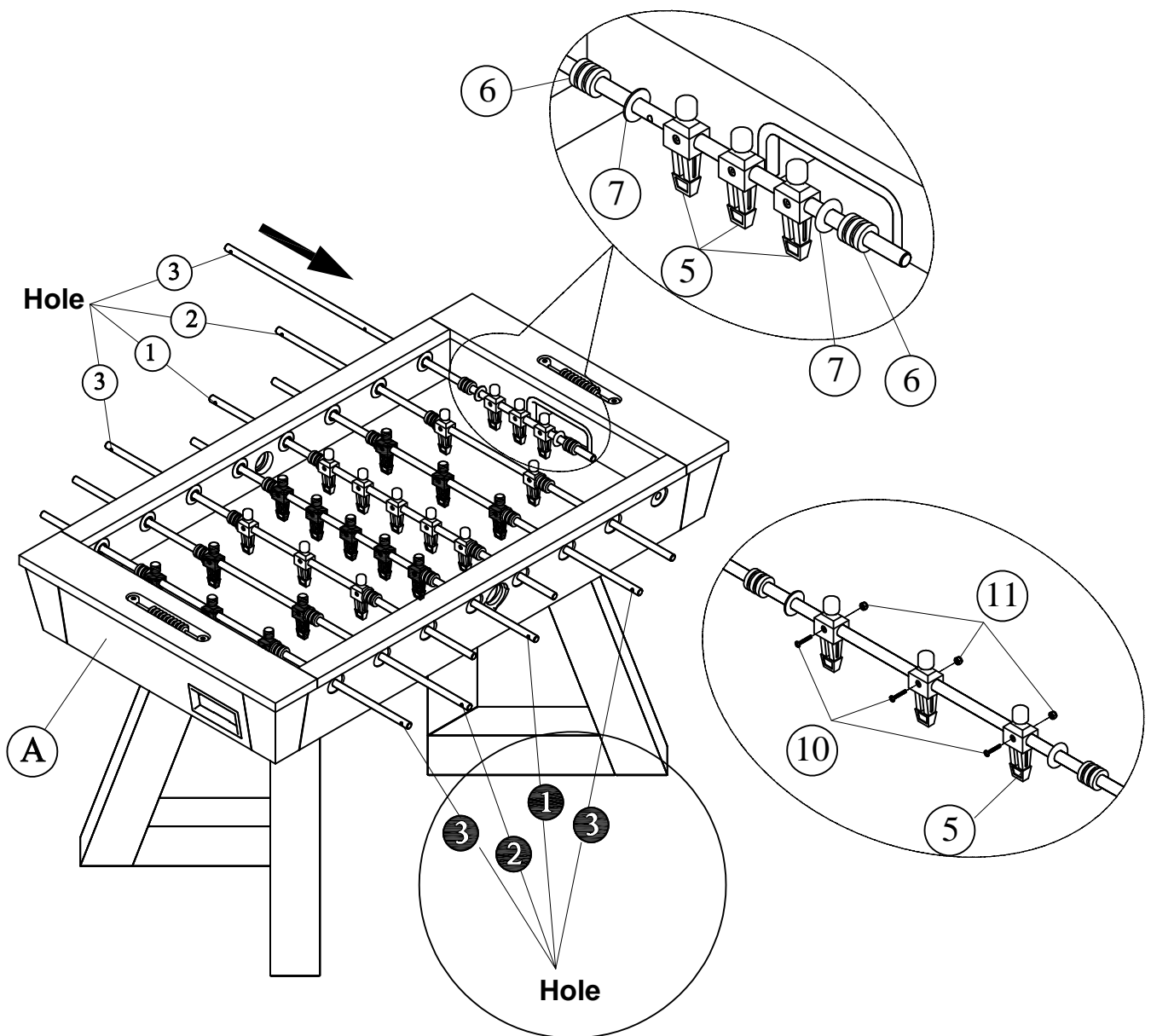



Aris Foosball Table Assembly Instruction

Step 7:

