

N701P353500

N701P353501

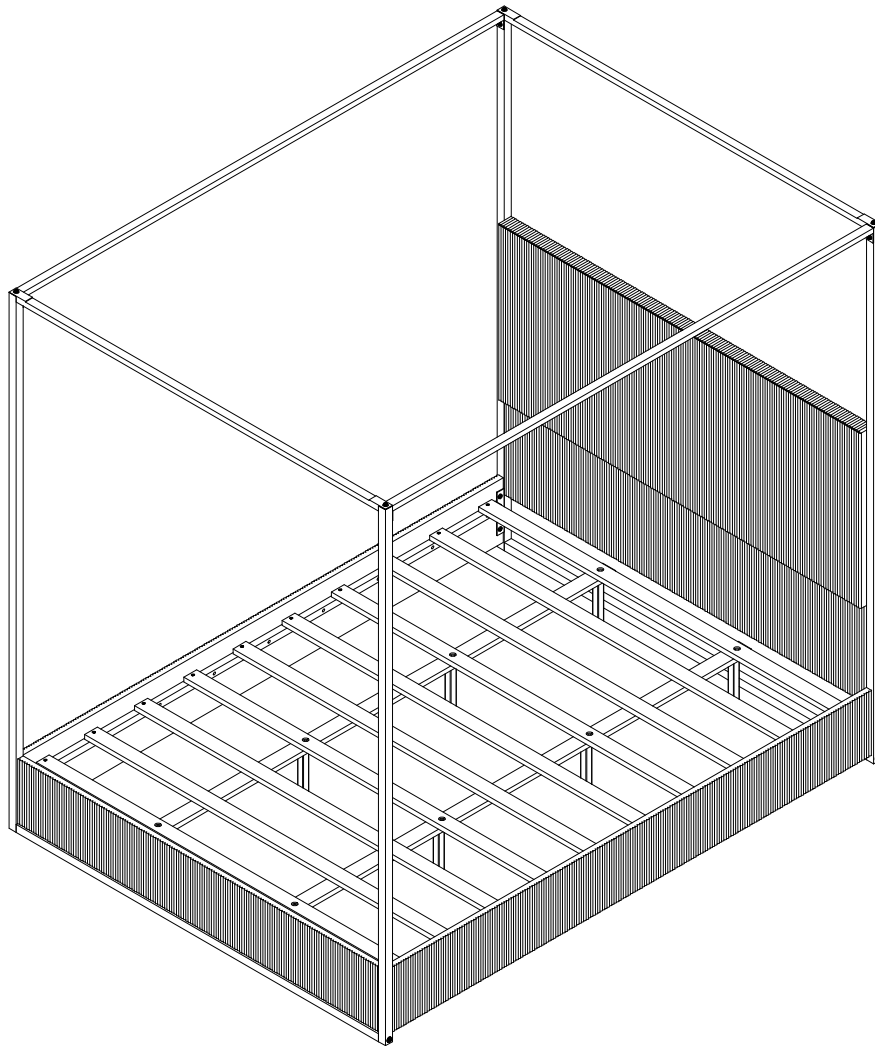

**ASSEMBLY INSTRUCTIONS
INSTRUCTIONS DE MONTAGE**

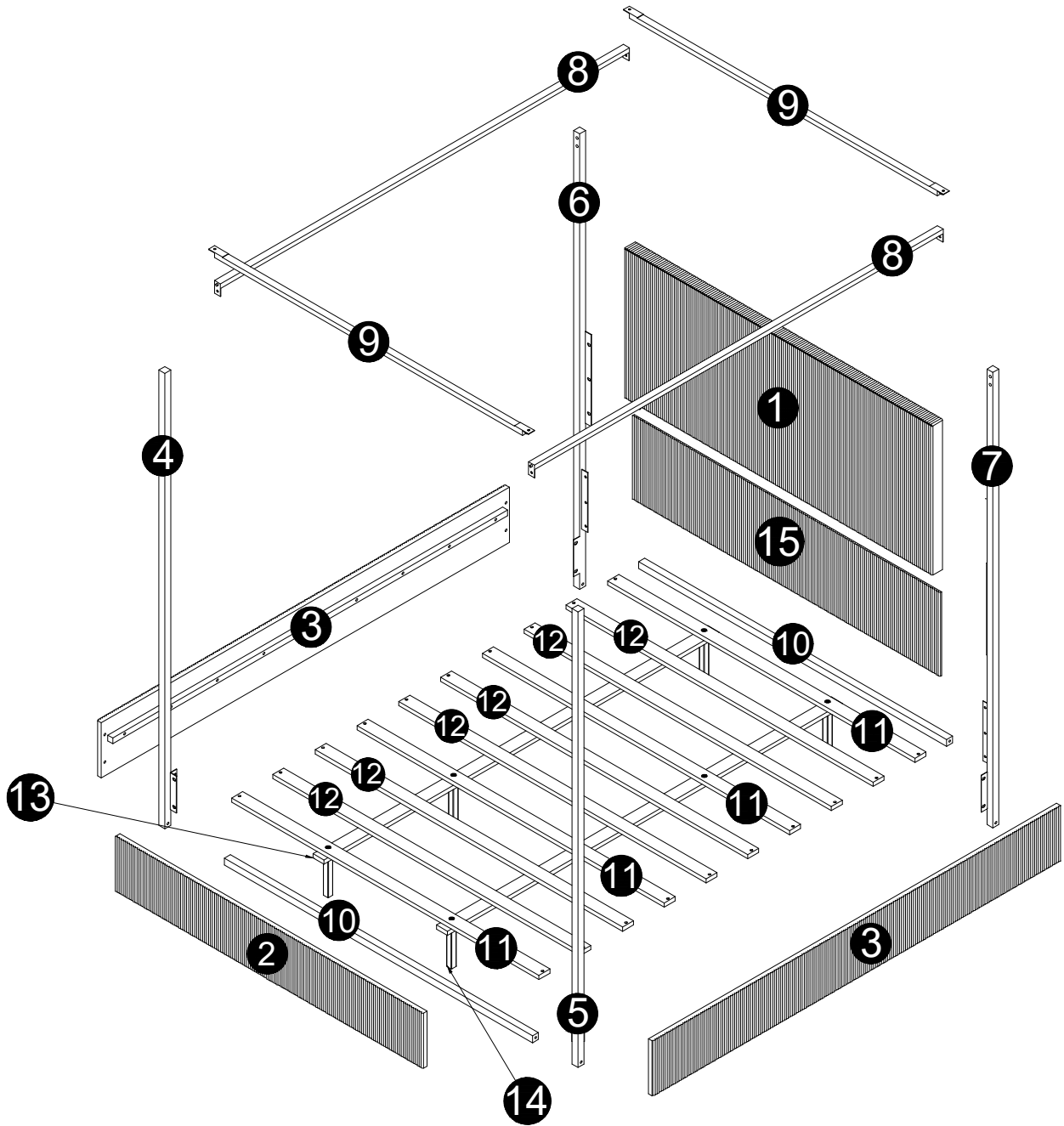

PARTS

LES PIÈCES

N701P353500

BOX:1/2

check that you've received all parts
listed below

vérifiez que vous avez reçu toutes les
pièces répertoriées ci-dessous

1 (1PC)

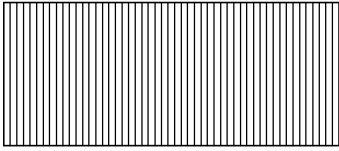

Head Board
Tête de lit

15 (1PC)

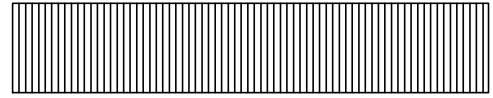

Support Bar
Bar de soutien

2 (1PC)



Foot Board
Planche à pied

11 (4PCS)

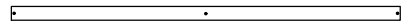

Slats
Lattes

12 (6PCS)

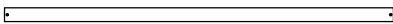

Slats
Lattes

14 (8PCS)

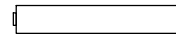

Support Legs
Jambes de soutien

HARDWARE

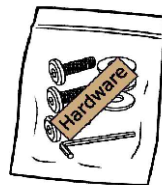

PARTS

LES PIÈCES

N701P353501

BOX:2/2

check that you've received all parts
listed below

vérifiez que vous avez reçu toutes les
pièces répertoriées ci-dessous

3 (2PCS)

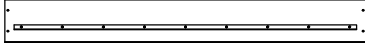

Side Board
Panneau latéral

5 (1PC)

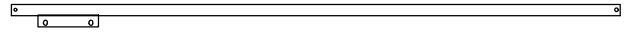

Bed Footboard Post
poteau de pied de lit

4 (1PC)

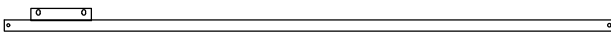

Bed Footboard Post
poteau de pied de lit

7 (1PC)

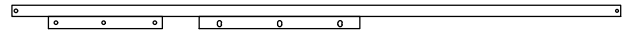

Bed Headboard Post
poteau de tête de lit

6 (1PC)

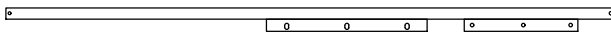

Bed Headboard Post
poteau de tête de lit

9 (2PCS)



Short Top Bar
barre courte en haut

8 (2PCS)

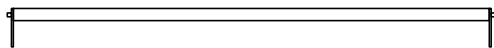

Long Top Bar
Longue barre en haut

13 (2PCS)

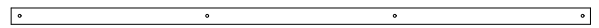

Support Slat
Latte de support







10 (2PCS)





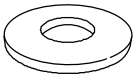
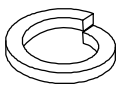

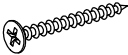
bottom reinforcement
renfort inférieur

HARDWARE LIST

LISTE DU MATÉRIEL



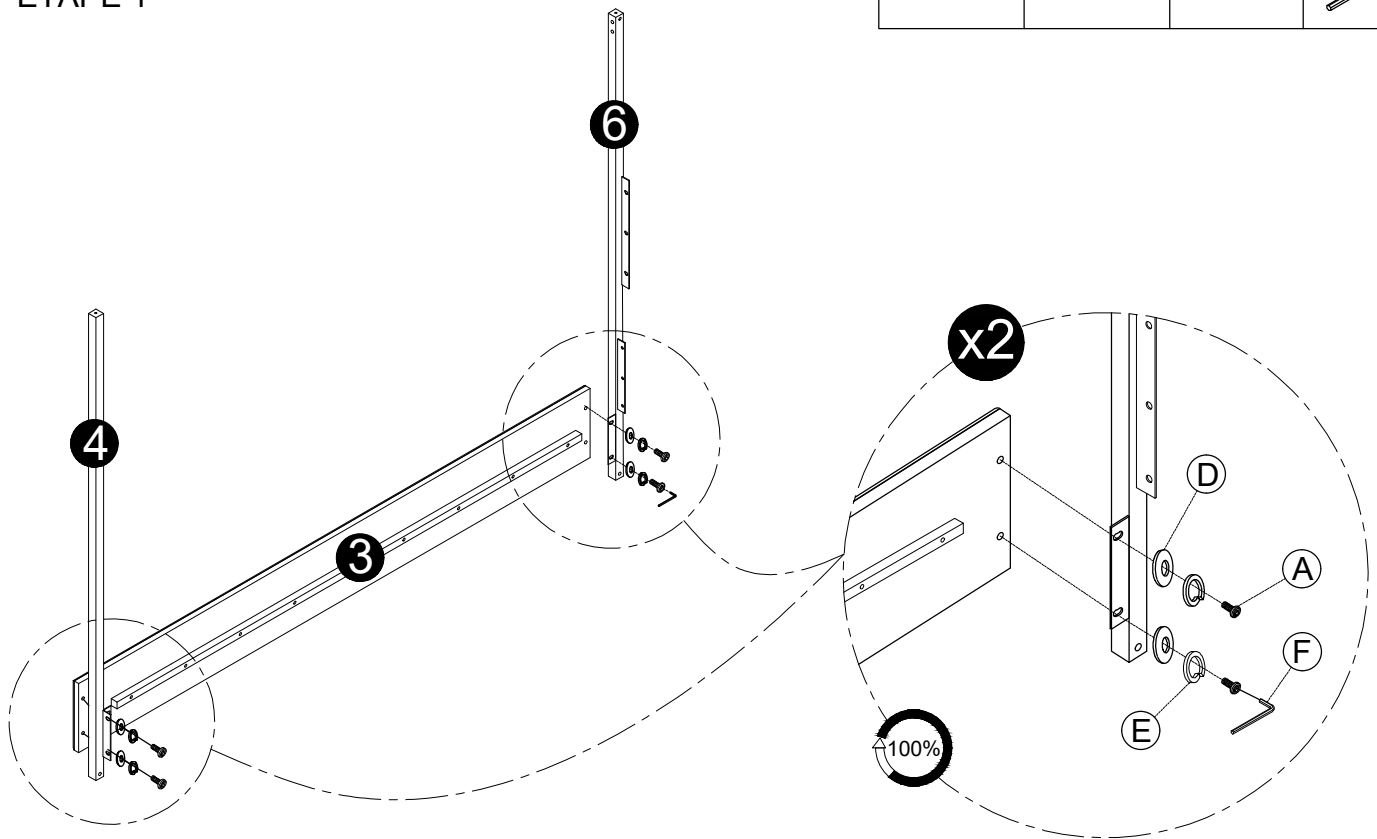

NO	OUTLOOK	DESC	QTY
A		Bolts 5/16*20mm	26 pcs
B		Bolts 5/16*50mm	4 pcs
C		Bolts 5/16*70mm	8 pcs
D		Flat washer Ø19x1.5 mm	38 pcs
E		Spring washer Ø13x1 mm	38 pcs
F		Allen wrench 80x30x4 mm	1 pc
G		Screws Ø4x30 mm	20 pcs
H		L-Bracket 19x19*2 mm	4 pcs
I		Screws Ø4x12 mm	14 pcs

STEP 1
ÉTAPE 1

Ax4 	Dx4 	Ex4 	Fx1 
--	--	--	---





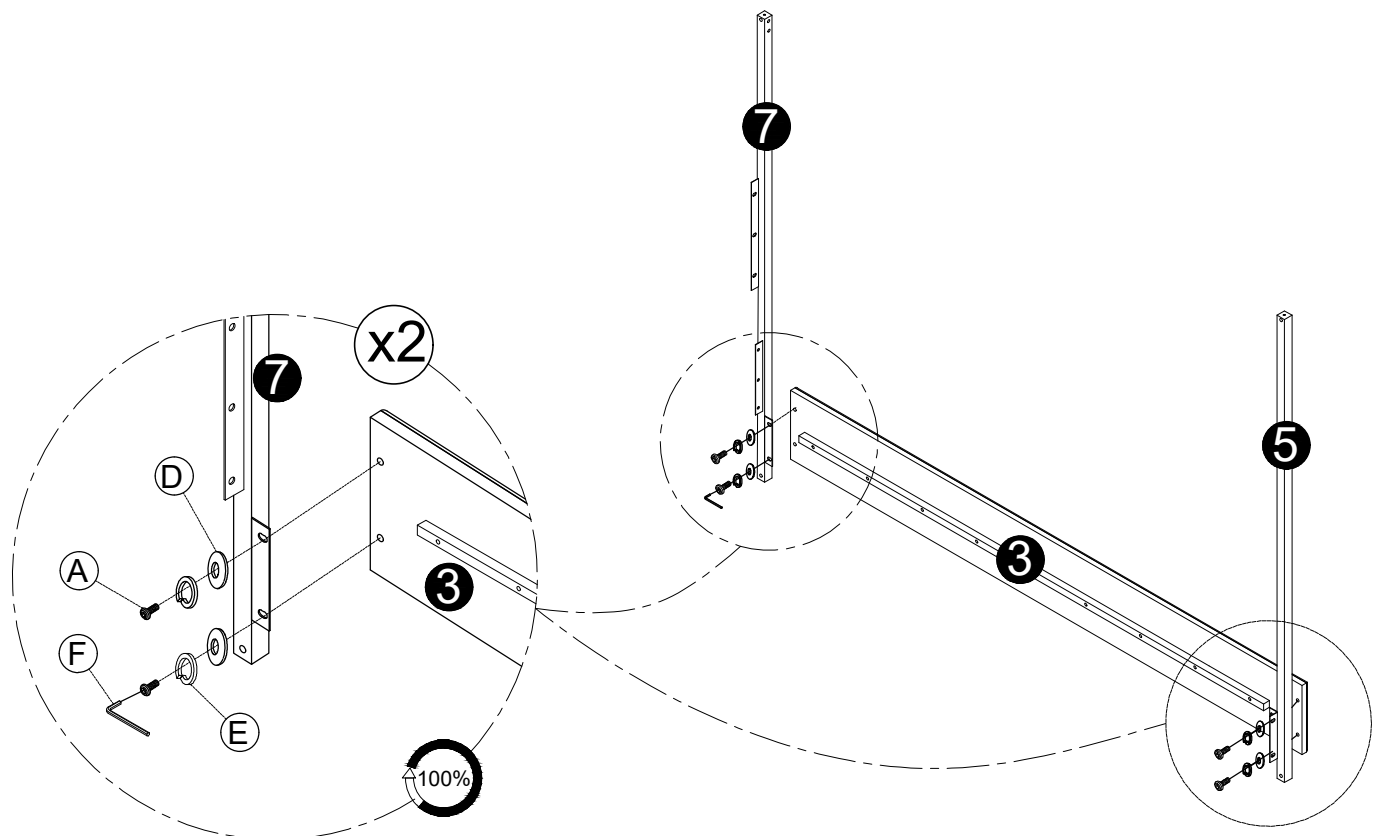

STEP 2
ÉTAPE 2

Ax4 	Dx4 	Ex4 	Fx1 
--	--	--	--





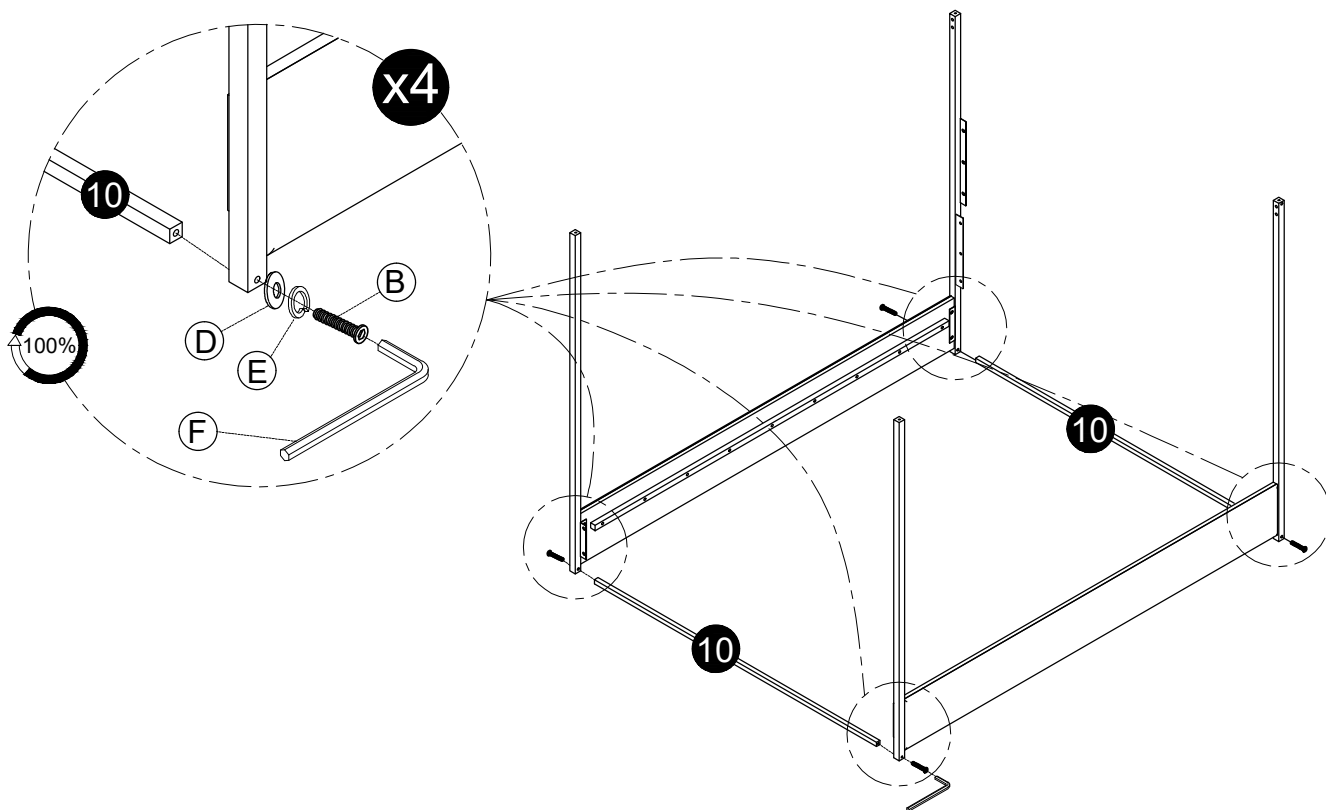

STEP 3
ÉTAPE 3

Bx4 	Dx4 	Ex4 	Fx1 
---	--	--	--





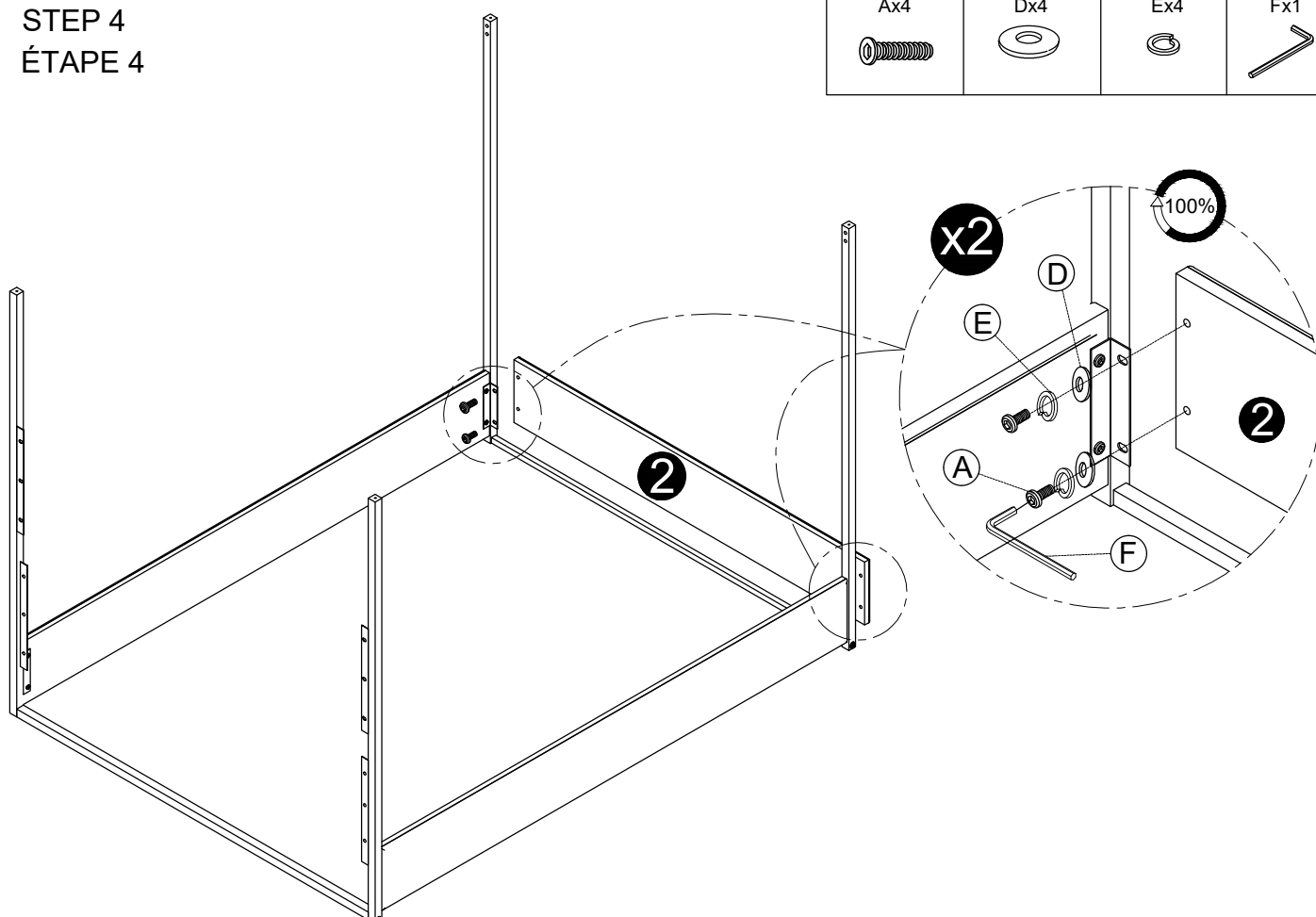

STEP 4
ÉTAPE 4

Ax4 	Dx4 	Ex4 	Fx1 
---	--	--	--



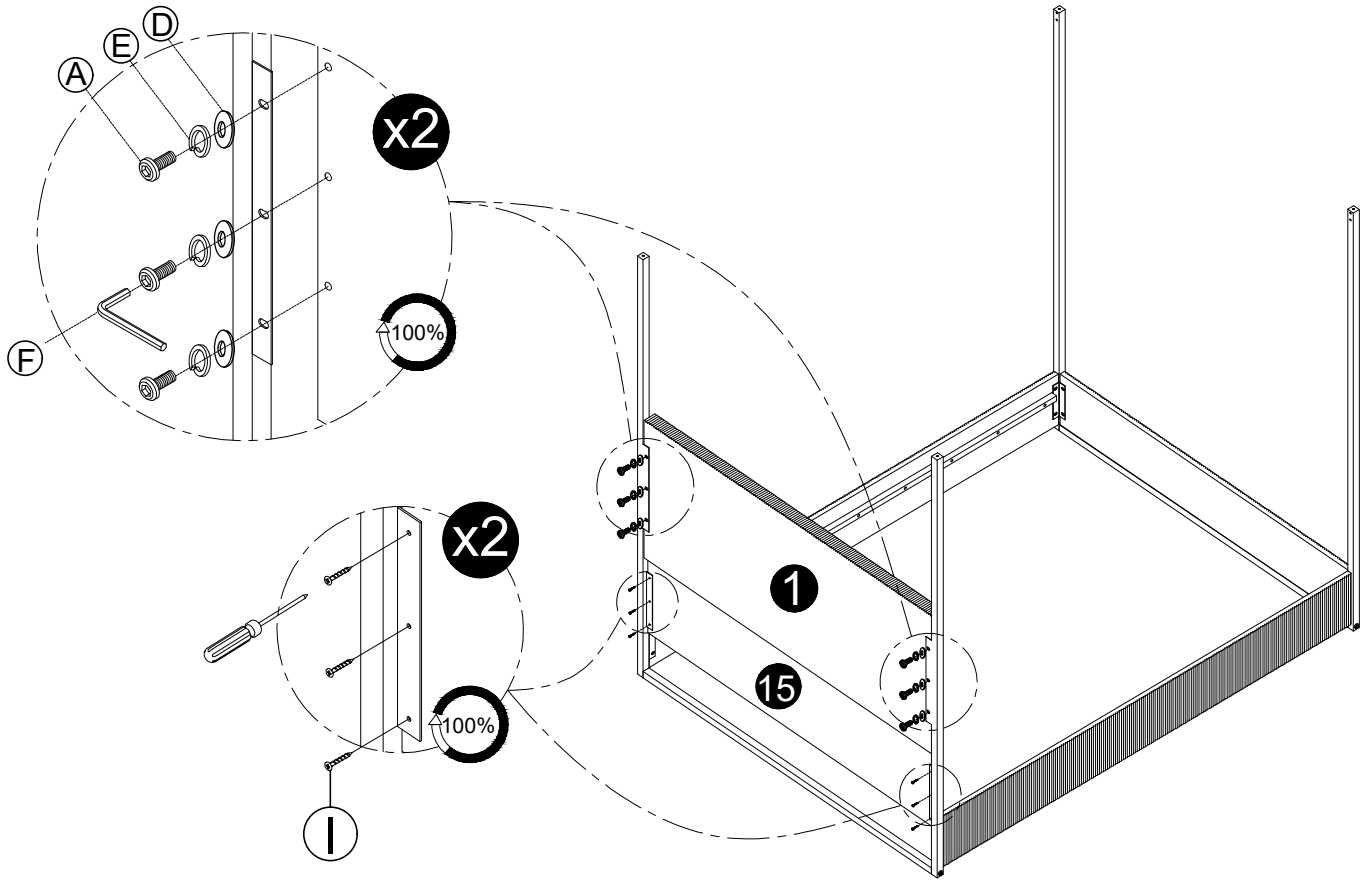

STEP 5
ÉTAPE 5

Ax6	Dx6	Ex6	Fx1	Ix6
				





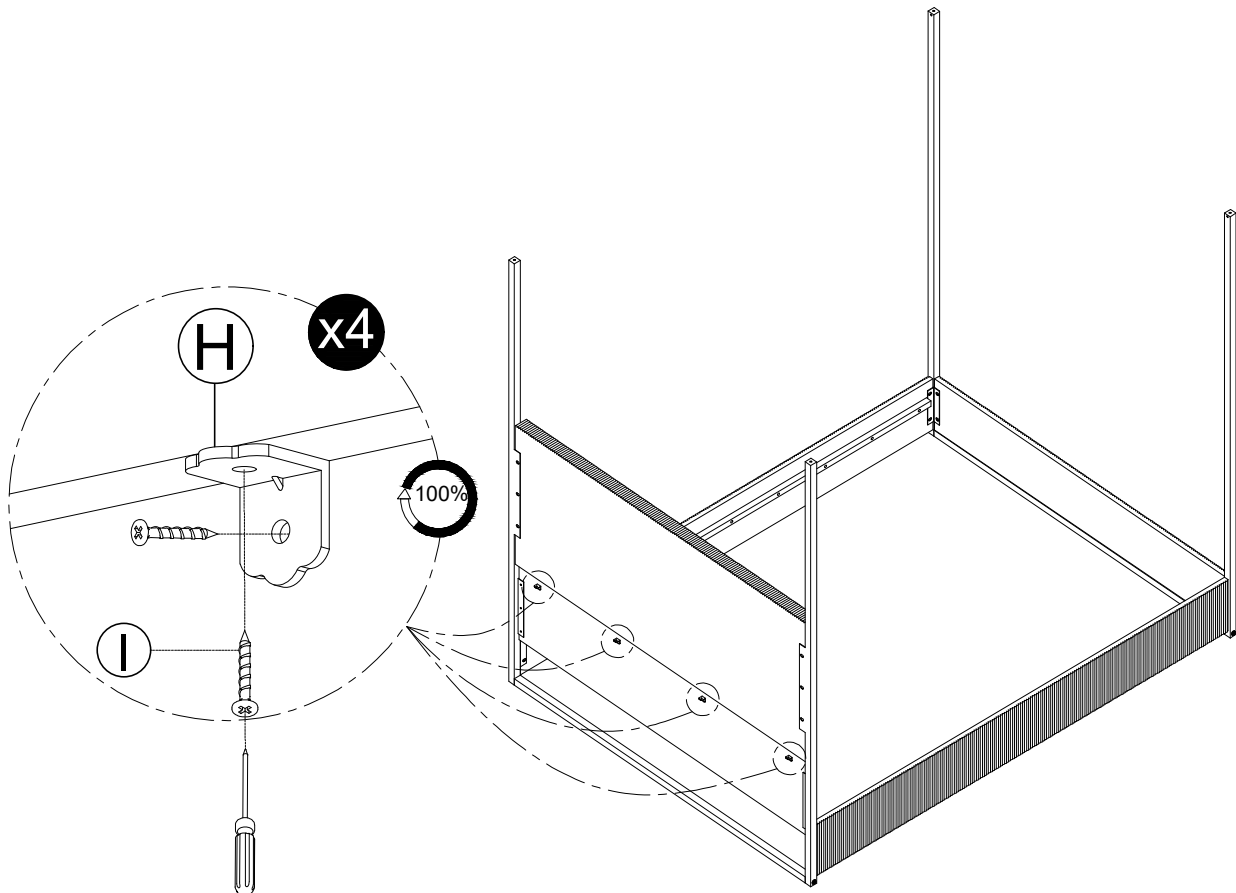

STEP 6
ÉTAPE 6

Hx4	Ix8
	



STEP 7
ÉTAPE 7

Cx8 	Dx8 	Ex8 	Fx1 	Gx8 
--	--	--	--	--

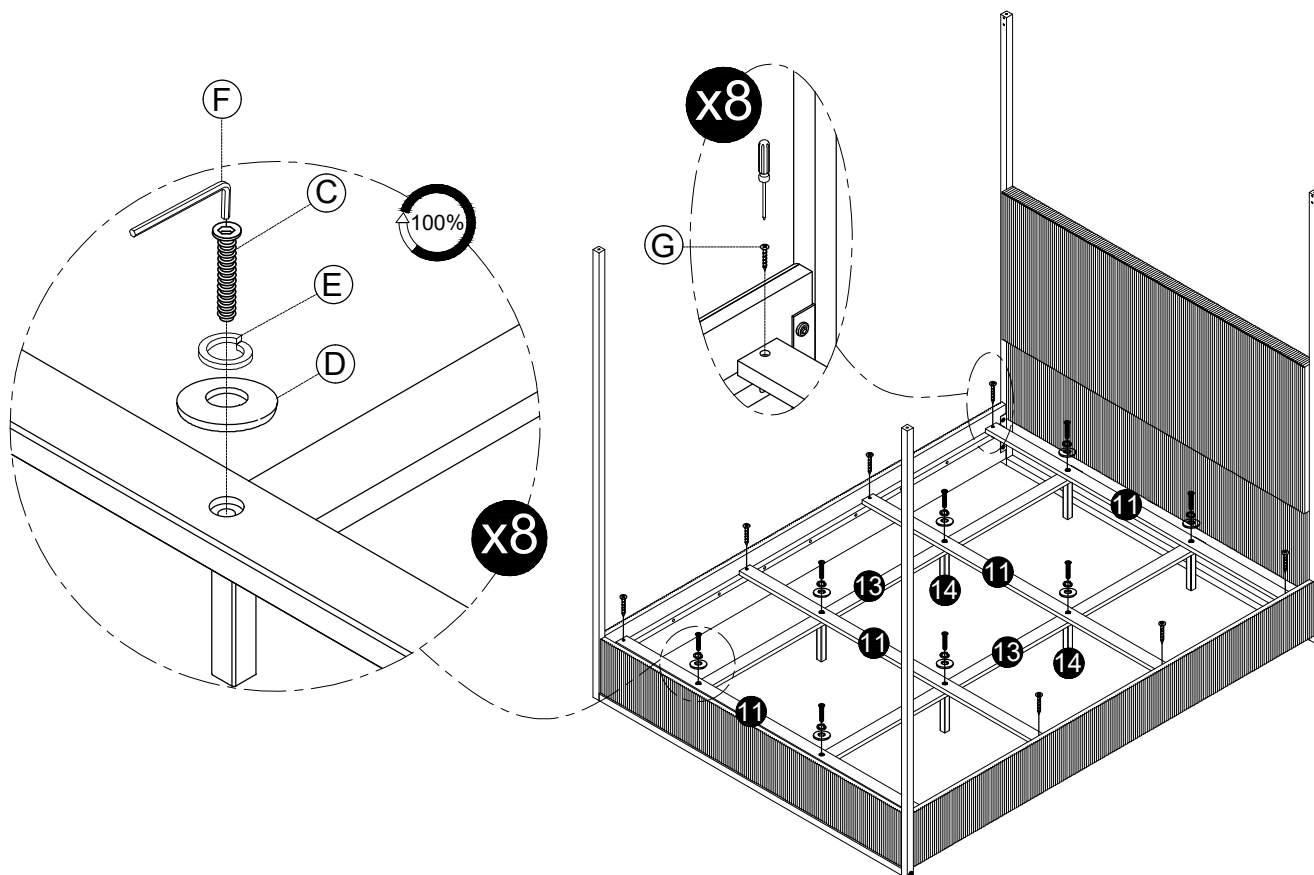



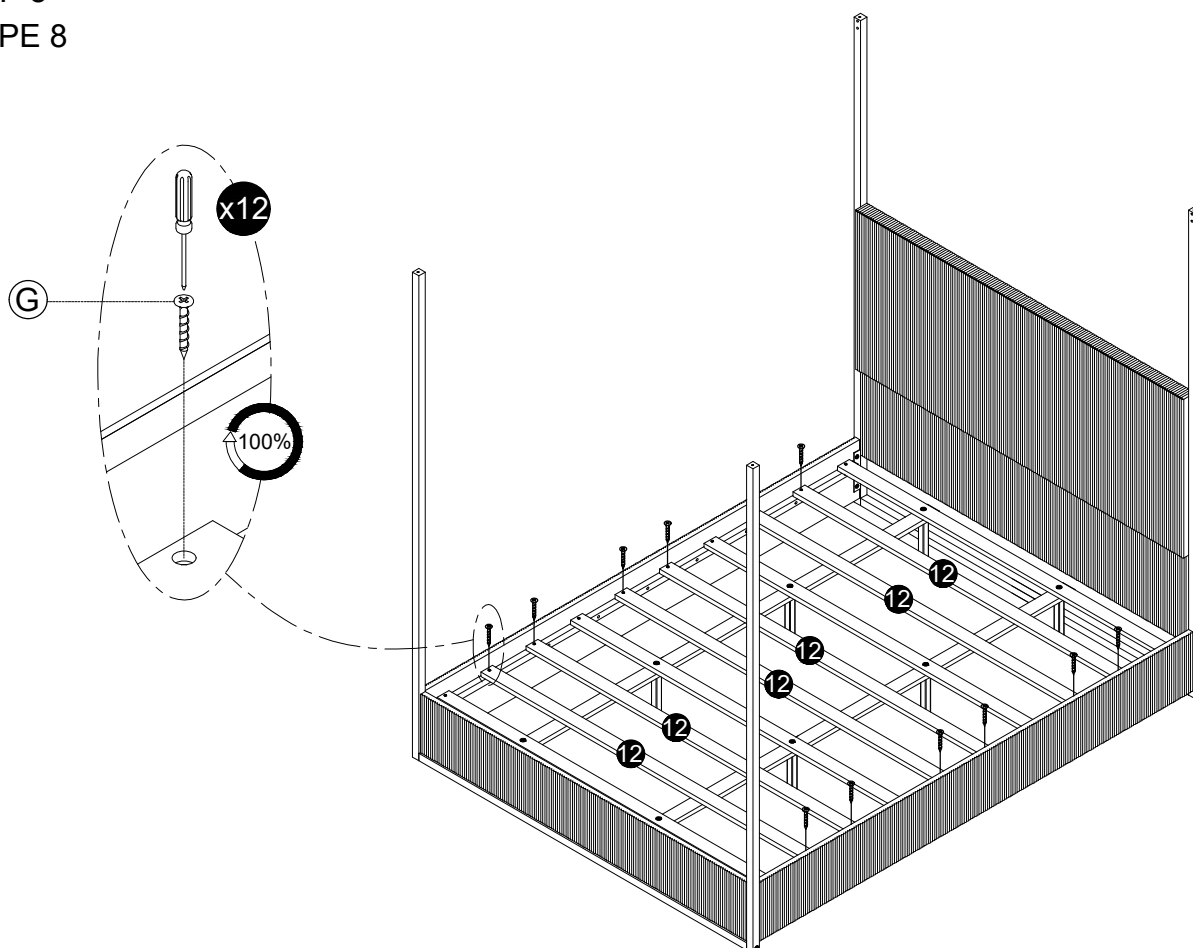

STEP 8
ÉTAPE 8

Gx12 



STEP 9
ÉTAPE 9

Ax8 	Dx8 	Ex8 	Fx1 
--	--	--	---

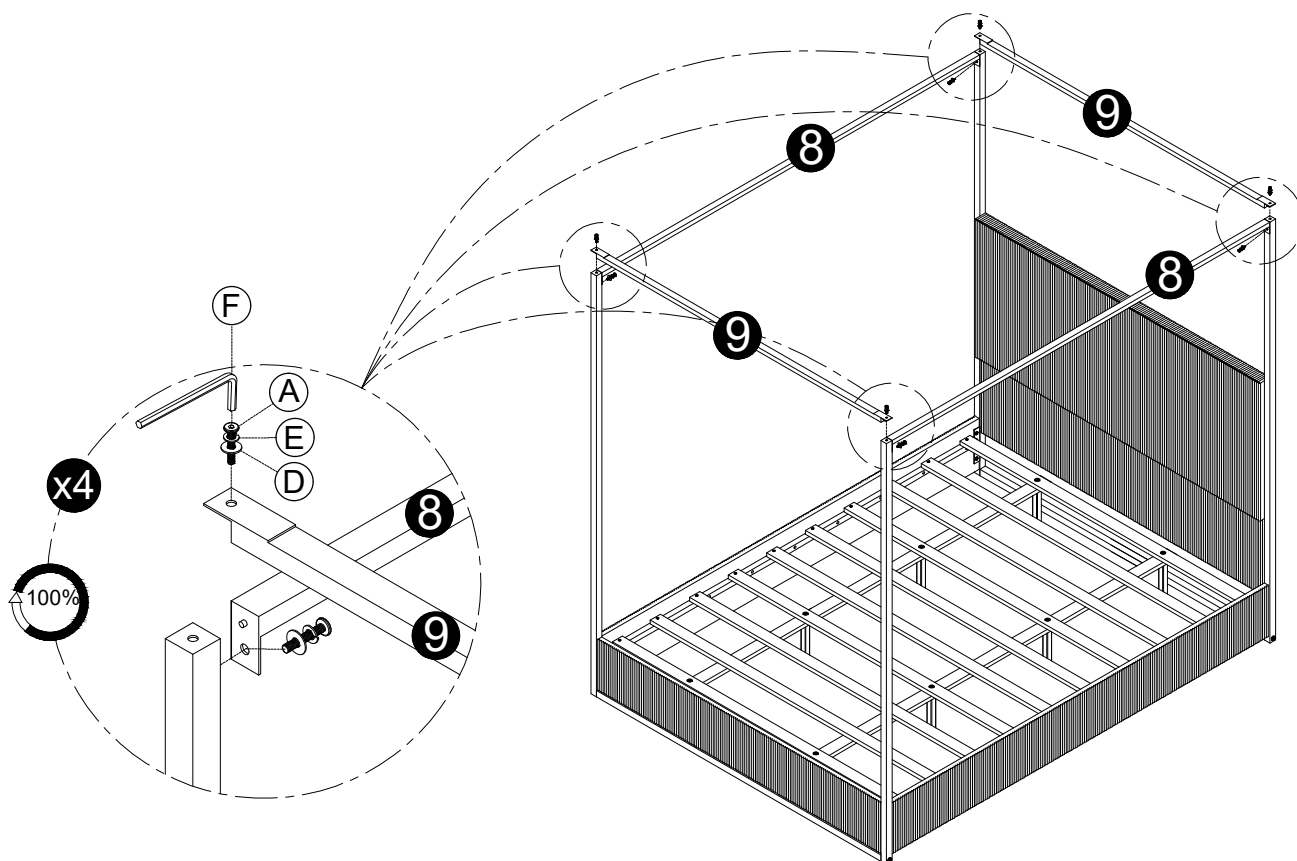

Finish
Finition

