

Owner Manual

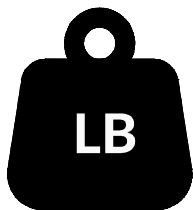
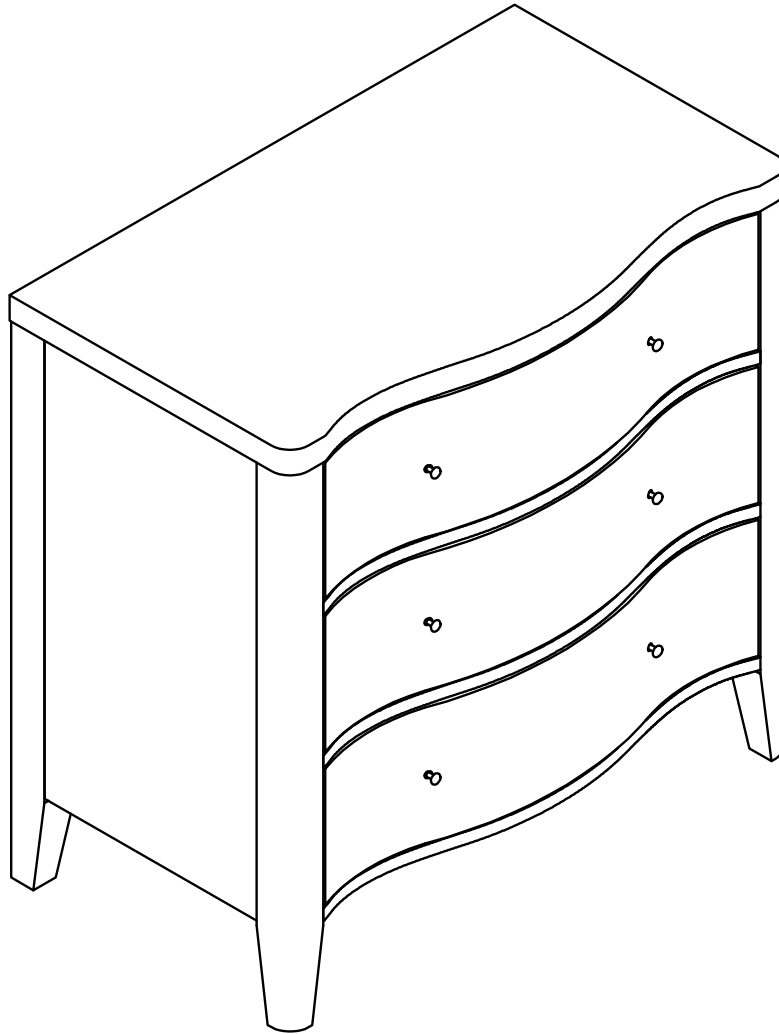

Per Seat Weight Limitation

110 LBS

NOTE:





This brochure contains
IMPORTANT safety info.
Please read and keep it
for future reference.

MAINTAINANCE AND WARNINGS



Before You Start

Please follow the steps below:

-  Check the packaging for any damage, deformation, or water stains. If there is significant damage, please contact us promptly.
-  Open the packaging and confirm that the panels, hardware, screws, etc are complete.
-  Please read the installation instructions carefully to understand the installation steps and precautions to ensure proper installation.
-  Clean the installation area in advance and ensure the ground is level and there is enough space to avoid damaging the furniture or making installation difficult.
-  Lay a protective mat on the ground to prevent scratching the floor during installation.

After-Sales Service

- If you encounter any issues or need technical support during use, please contact our after-sales team. We offer long-term maintenance and warranty services.



Precautions

- ⚠ This product for indoor use only. Do not expose it to outdoor elements or high-humidity environments.
- ⚠ Keep the product away from high heat or open flames to prevent fire hazards.
- ⚠ Do not allow children to climb on the product to prevent personal injury caused by tipping



Safety Warnings

- ⚠ If you notice any loose or damaged parts, stop using the product immediately and contact customer service.
- ⚠ Do not attempt to disassemble or replace any components yourself, as this may affect the stability and safety of the product.

Daily Maintenance

- Regularly clean the surface of the sofa with a soft cloth to prevent dust accumulation.
- Do not use cleaning agents containing acids, alkalis, or corrosive substances, as they may damage the surface. It is recommended to use neutral cleaning agents or specialized furniture cleaners
- Avoid exposing furniture to humid environments for extended periods to prevent swelling or deformation of the boards. Use a dehumidifier or desiccant during humid weather.
- Avoid direct contact of furniture with water. If water is accidentally spilled, wipe it dry immediately.
- Avoid placing excessively heavy objects on the furniture: ensure the weight is within a reasonable load-bearing range.
- Avoid using sharp or rough items on the furniture surface to prevent scratches, Handle items gently when moving them

Hardware List

1

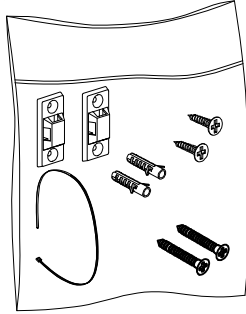

x2

2

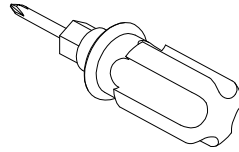

x1

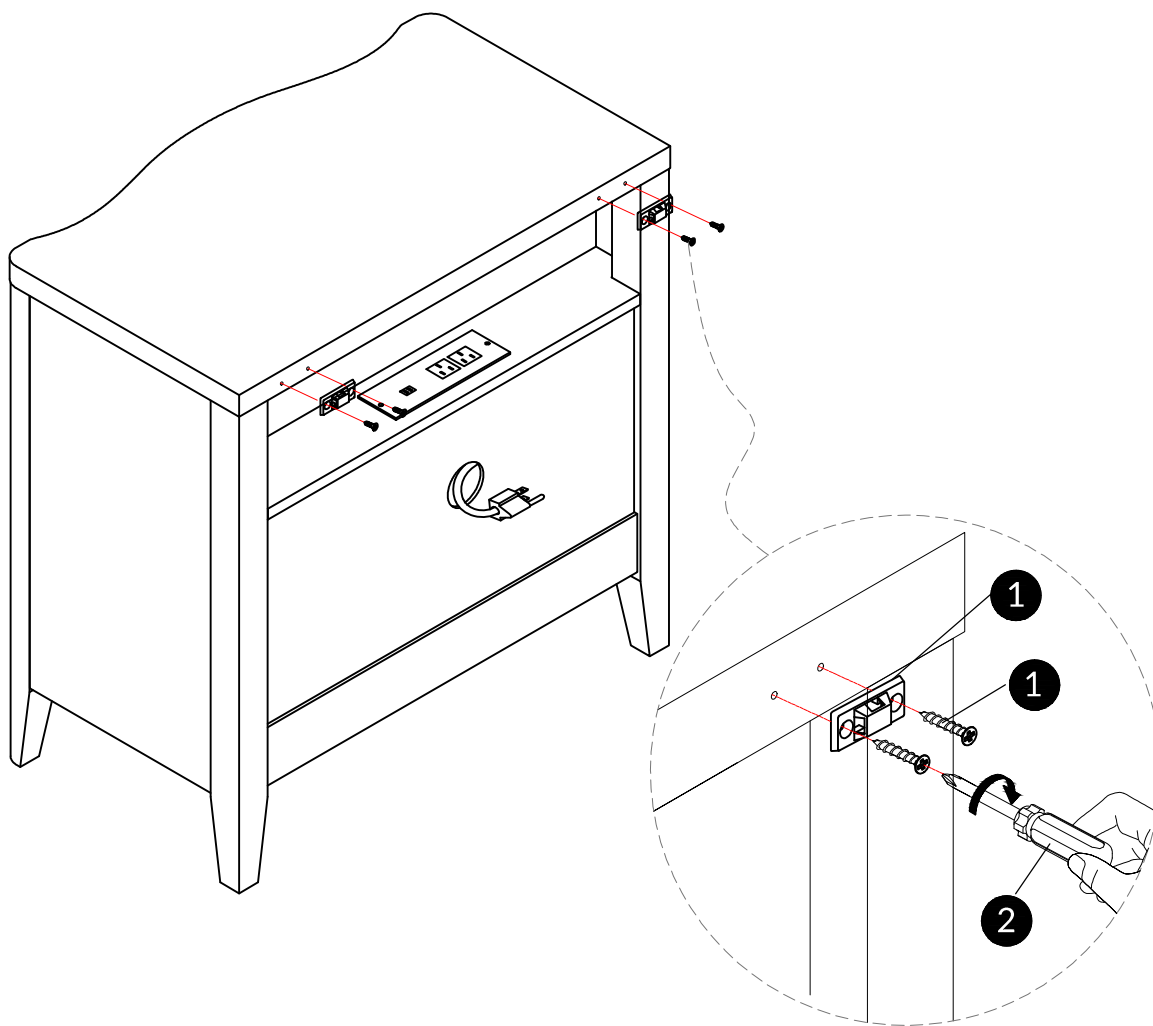

Step 1

Use screw #1-2 to attach part #1-1 to panel, tight screw with screwdriver 2.



1	x2	1	x4	1	x2	2	x1

Step 2

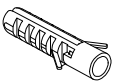
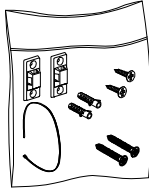
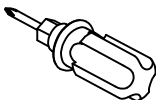
1	x2	1	x4	1	x4	1	x2	2	x1
									

1. Install the anti-collapse device.

2. Mark the position on the wall, that corresponds to the location of part #1-1 on the of panel ; Drill and insert the expandable screw #1-4 by hammer.

3. Assemble the part #1-1 to the wall. Align the hole in the part #1-1 with the expandable screw #1-4, use screw #1-3 to attach it and tighten by screwdriver

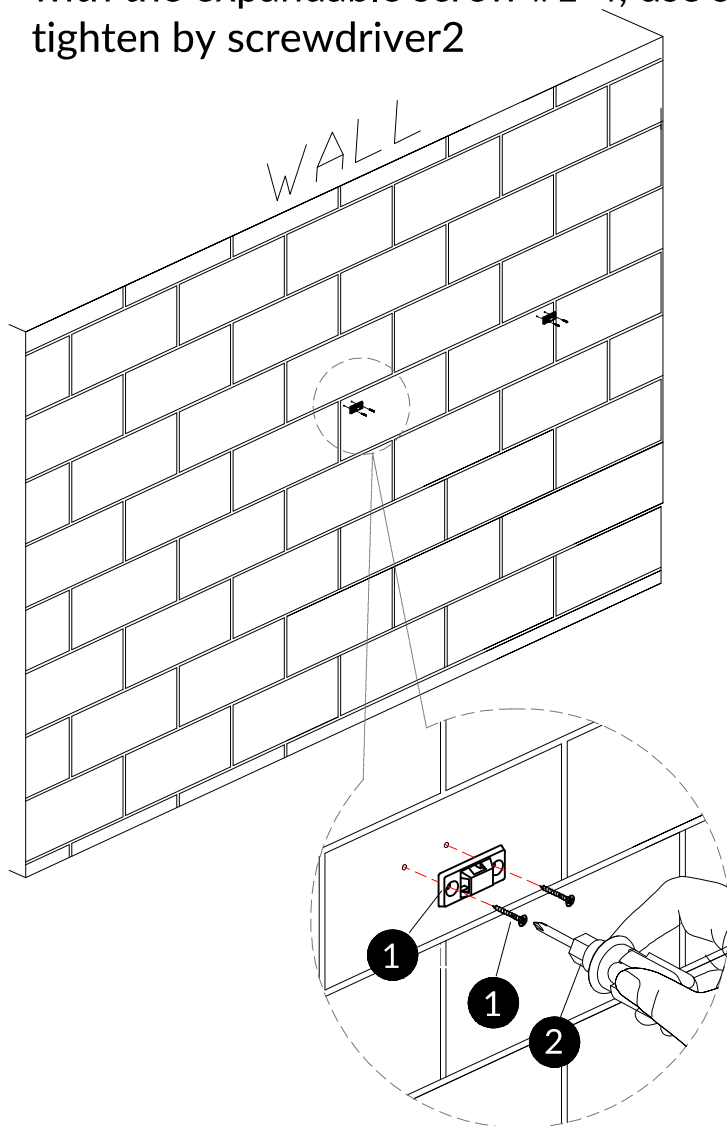

NOT PROVIDED

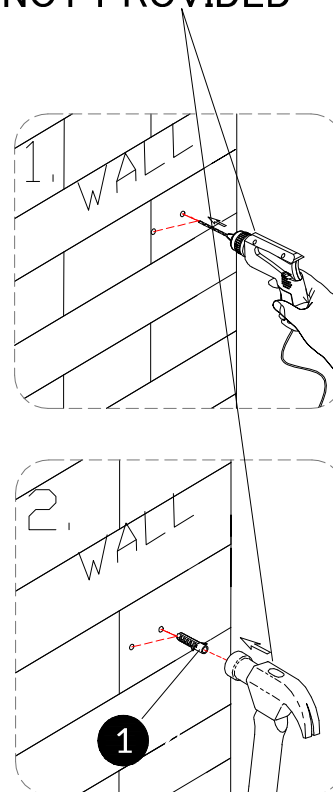

Step 3

Let the plastic belt #1-5 pass through the both part #1-1 and pull tightly.

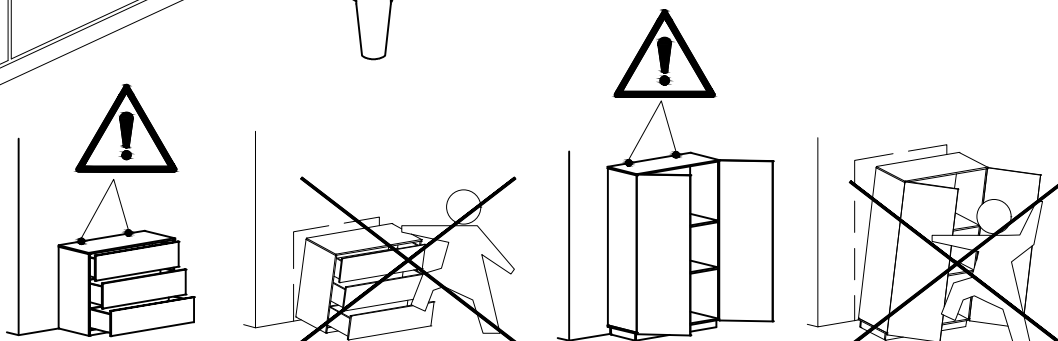
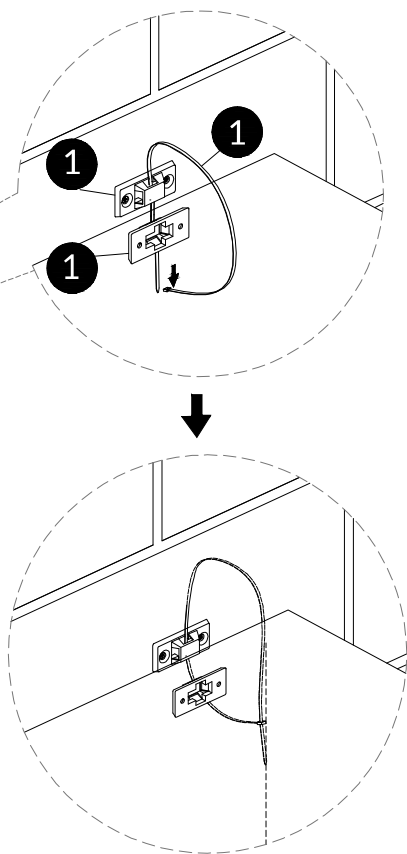
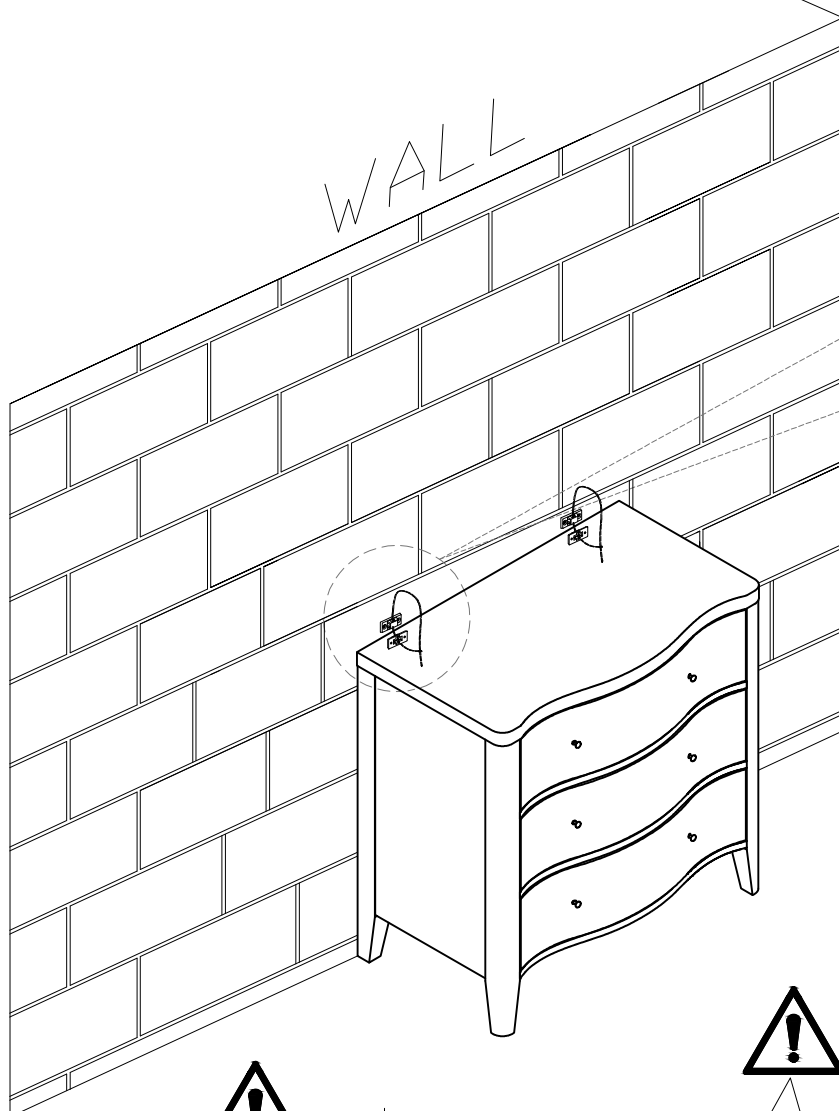
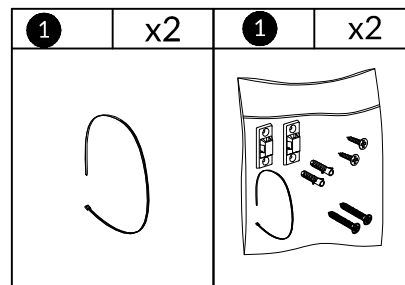

WARRANTY

- We strive to offer quality products, and we also try our best to satisfy every customer who orders from us with products or services as needed.
- We provide 30 days warranty starting from the time you receive the item. Each customer must provide a record of their orders such as the order number, or item receipt for any items that are out of the warranty period you may also still receive.
- Replacement parts by purchasing them from our company if they are available.
- For return, please check the return policy with the retailer or market place you bought from