

90'

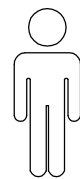

2

A

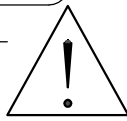
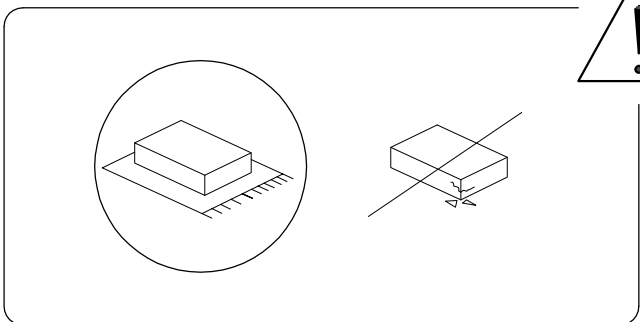
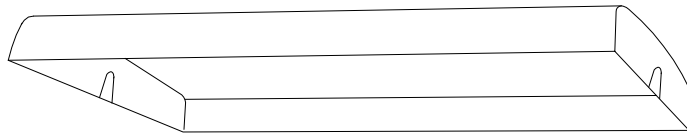

B

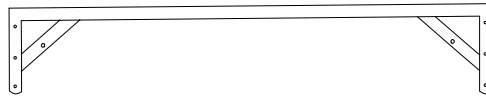

C x 2

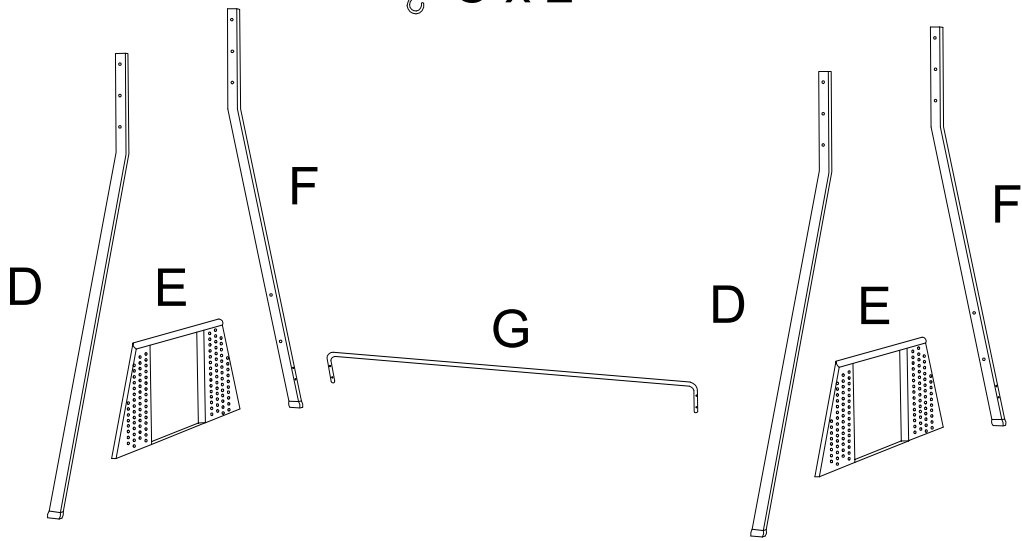

H

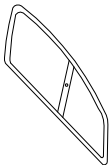

G

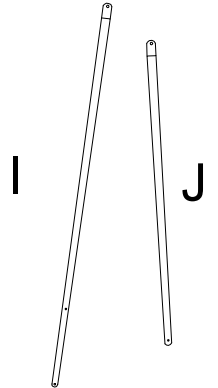
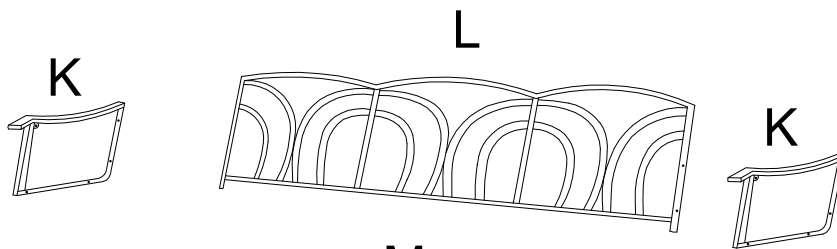
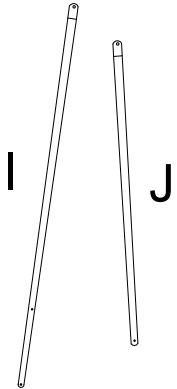
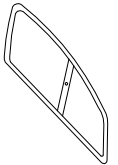



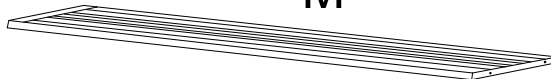



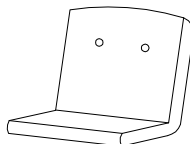

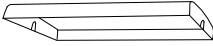

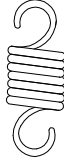

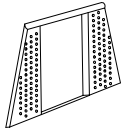

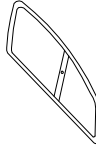

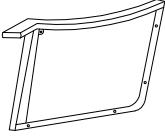

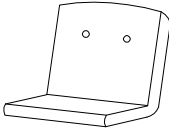
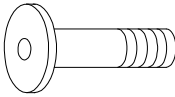
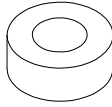
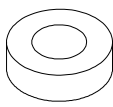
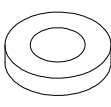

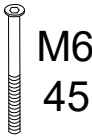

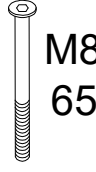
M











N x 3







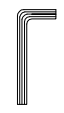

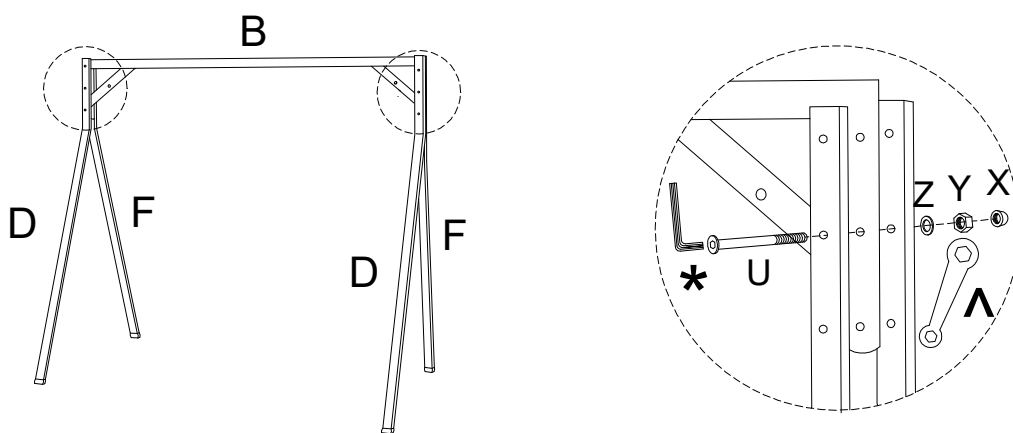

<p>A</p>  <p>x 1</p>	<p>B</p>  <p>x 1</p>	<p>C</p>  <p>x 2</p>	<p>D</p>  <p>x 2</p>	<p>E</p>  <p>x 2</p>	
<p>F</p>  <p>x 2</p>	<p>G</p>  <p>x 1</p>	<p>H</p>  <p>x 2</p>	<p>I</p>  <p>x 2</p>	<p>J</p>  <p>x 2</p>	
<p>K</p>  <p>x 2</p>	<p>L</p>  <p>x 1</p>	<p>M</p>  <p>x 1</p>	<p>N</p>  <p>x 3</p>	<p>O</p>  <p>x 2</p>	
<p>P</p>  <p>15 x 20</p> <p>x 2</p>	<p>Q</p>  <p>15 x 15</p> <p>x 2</p>	<p>R</p>  <p>15 x 7</p> <p>x 6</p>	<p>S</p>  <p>M6 20</p> <p>x 8</p>	<p>T</p>  <p>M6 45</p> <p>x 2</p>	
<p>U</p>  <p>M8 85</p> <p>x 14</p>	<p>V</p>  <p>M8 70</p> <p>x 2</p>	<p>W</p>  <p>M8 65</p> <p>x 2</p>	<p>X</p>  <p>M8</p> <p>x 18</p>	<p>Y</p>  <p>M8</p> <p>x 18</p>	
<p>Z</p>  <p>M8</p> <p>x 18</p>	<p>#</p>  <p>M6</p> <p>x 2</p>	<p>@</p>  <p>M6</p> <p>x 2</p>	<p>&</p>  <p>M6</p> <p>x 2</p>	<p>^</p>  <p>x 1</p>	<p>*</p>  <p>x 1</p>

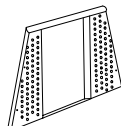
1

<p>B</p>  <p>x 2</p>	<p>D</p>  <p>x 2</p>	<p>F</p>  <p>x 2</p>	<p>U</p>  <p>M8 85 x 6</p>	
<p>X</p>  <p>M8 x 6</p>	<p>Y</p>  <p>M8 x 6</p>	<p>Z</p>  <p>M8 x 6</p>	<p>Λ</p>  <p>x 1</p>	<p>*</p>  <p>x 1</p>





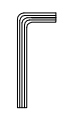

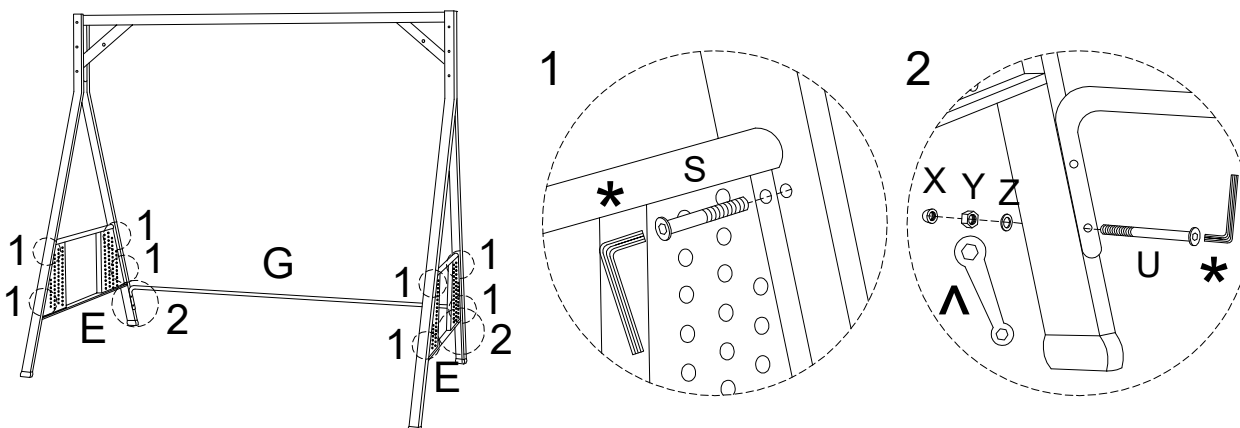





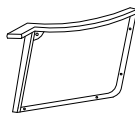
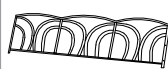







2

<p>E</p>  <p>x 2</p>	<p>G</p>  <p>x 1</p>	<p>S</p>  <p>M6 20 x 8</p>	<p>U</p>  <p>M8 85 x 4</p>	
<p>X</p>  <p>M8 x 4</p>	<p>Y</p>  <p>M8 x 4</p>	<p>Z</p>  <p>M8 x 4</p>	<p>Λ</p>  <p>x 1</p>	<p>*</p>  <p>x 1</p>

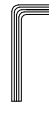

3

I  x 2	J  x 2	K  x 2	L  x 1	M  x 1	P  15 x 20 x 2	
Q  15 x 15 x 2	R  15 x 7 x 6	T  M6 45 x 2	U  M8 85 x 4	V  M8 70 x 2	W  M8 65 x 2	X  M8 x 8
Y  M8 x 8	Z  M8 x 8	#  M6 x 2	@  M6 x 2	&  M6 x 2	^  x 1	*  x 1

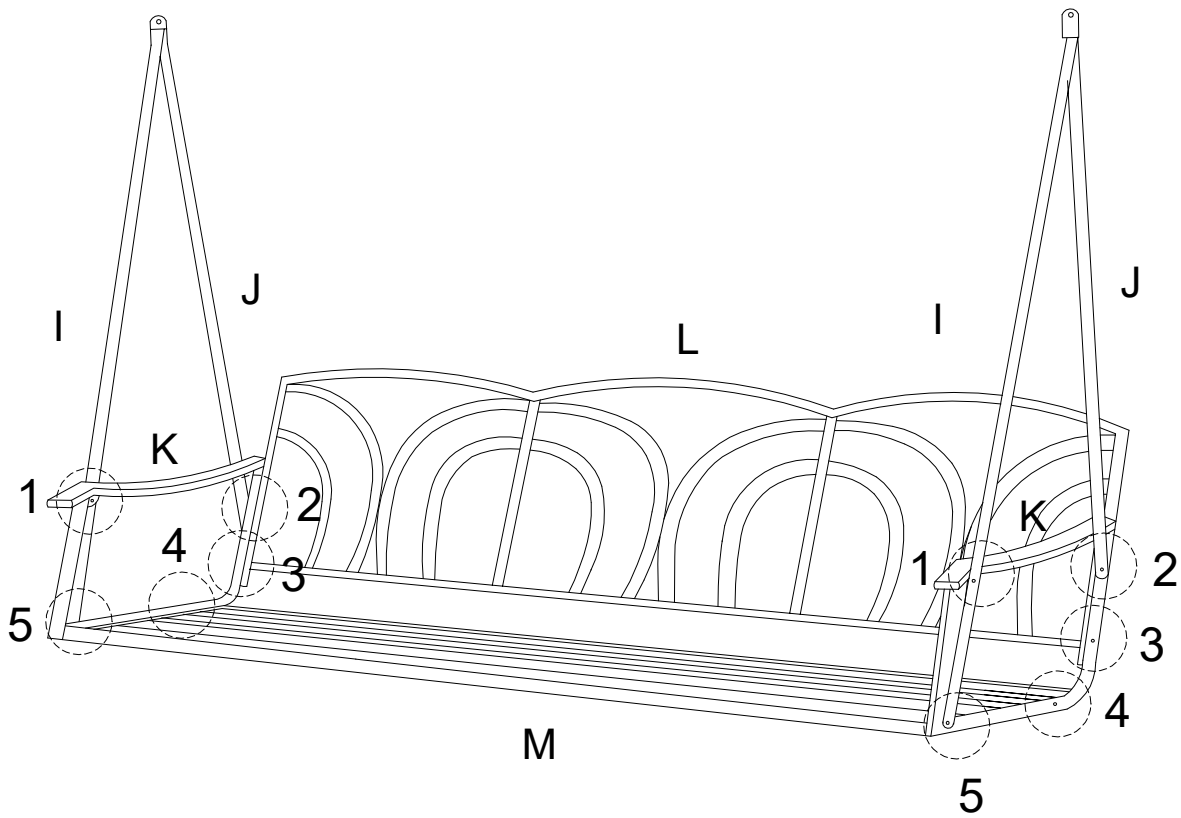

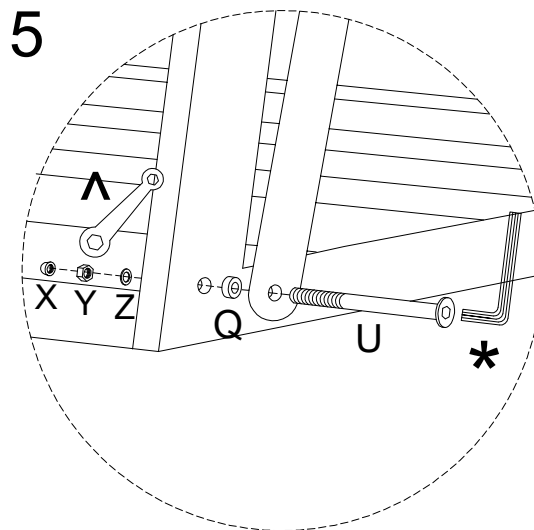
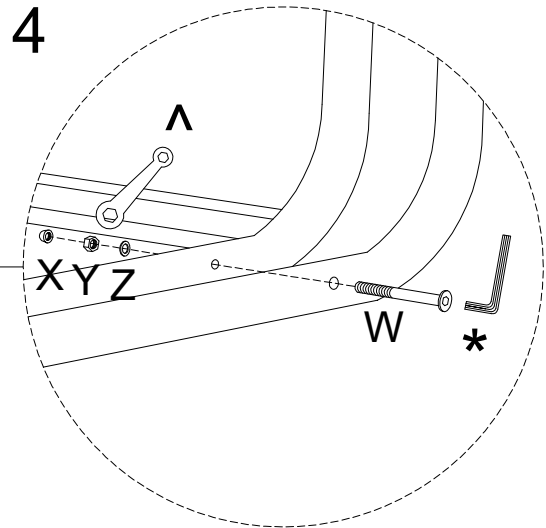
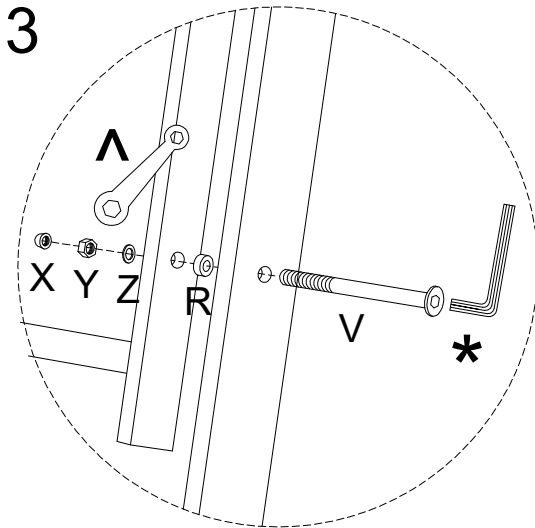
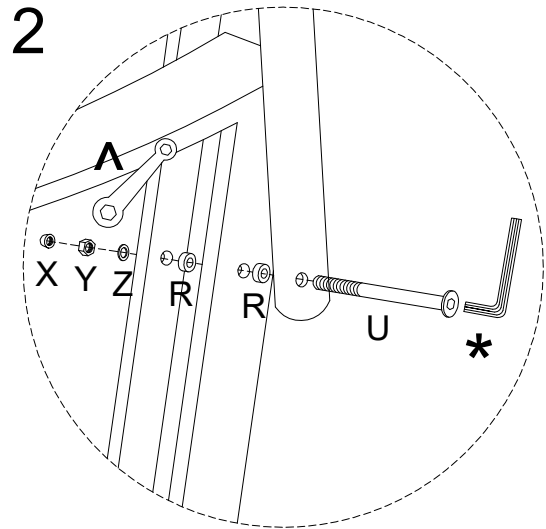
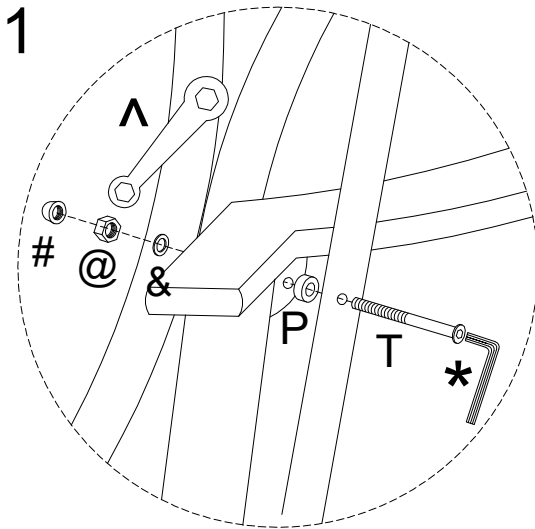

4

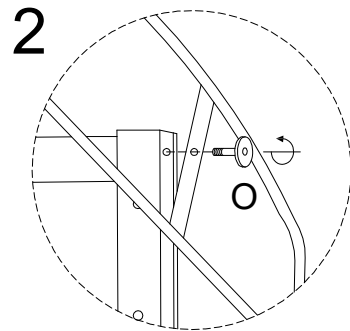
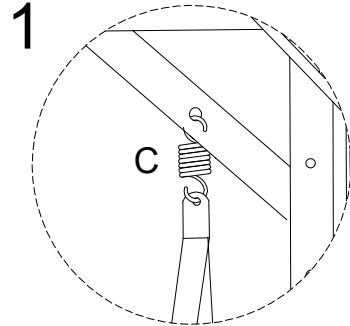
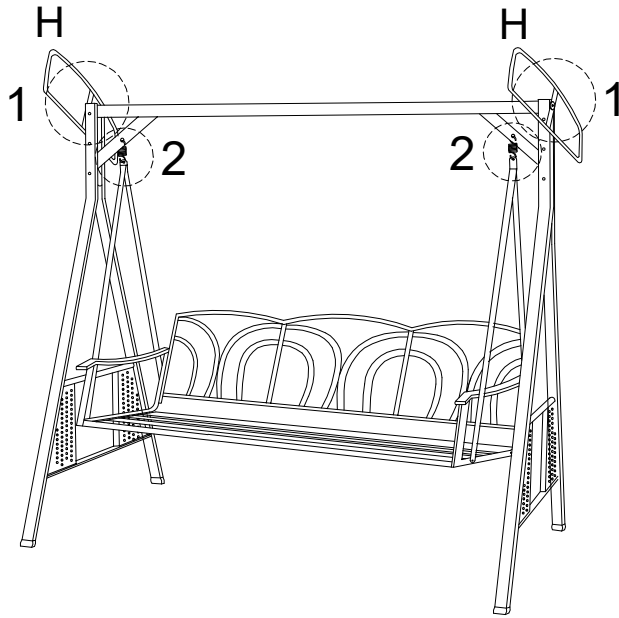
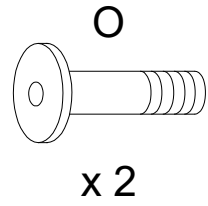
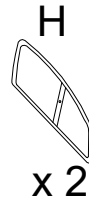

5

