

Assembly Instruction

Tools Required: Flathead screwdriver, Phillips screwdriver, pliers, wire cutters, wire strippers, electrical tape, safety glasses.

Light Source: (3) A19 Medium Base bulbs 100W Maximum or
(3) Medium Base Vintage bulbs are recommended but not supplied.

Estimated Assembly Time: 20-30 minutes

Preparation: Identify and inspect all parts before beginning installation. Check package content list and diagrams below to be sure all parts are present. If any parts are missing or damaged, do not attempt to assemble, install, or operate the fixture. Contact customer service for replacement parts.

⚠ Warnings and Cautions

Turn off electricity at circuit breaker or main fuse box before installation. Consult a licensed electrician if in doubt.

These instructions are provided for your safety. It is very important you read them completely before installing the fixture. We strongly recommend that a licensed, professional electrician perform the installation.

Disconnect fixture from power source before replacing bulbs. Make sure bulbs are given sufficient time to cool before removal.

Package Contents

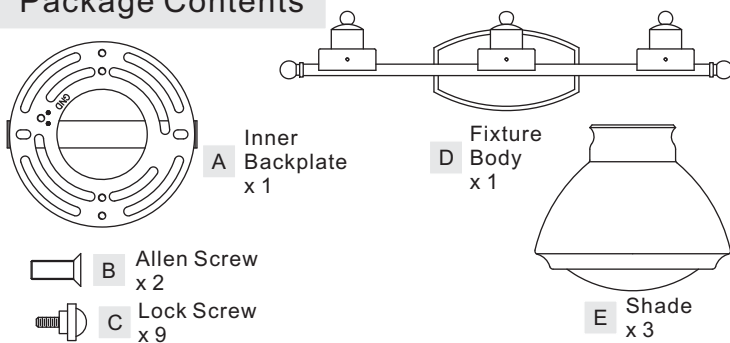

STEP 2 - Wire Connections

A. Use standard wire connectors (not included) to make all wire connections. Twist connectors until wires are tightly joined together. Wrap each connection with approved electrical tape and carefully stuff all the connected wires between Inner Backplate (A) and Fixture Body (D).

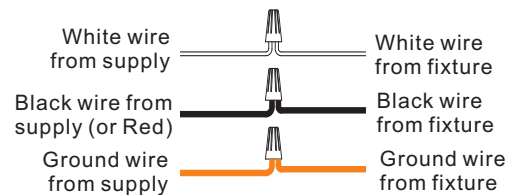

Figure 2

STEP 1 - Install Inner Backplate and Fixture Body

- Pass the supply wires through Inner Backplate (A). Attach Inner Backplate (A) to Outlet Box with the head of Green Ground Screw facing you. Secure it with Outlet Box Screws (not included). Tighten until snug.
- Refer to Step 2 for wiring connections.
- Attach Fixture Body (D) over Inner Backplate (A) and secure with Allen Screws (B). Tighten until snug with screwdrivers.

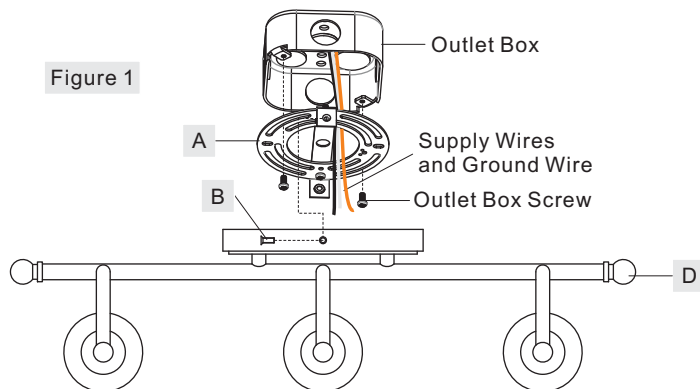

Figure 1

STEP 3 - Install Bulbs and Shade

- Insert bulbs onto sockets and screw snugly into place.
- Place Shade (E) into socket cup and hold it by hands. Thread Lock Screws (C) into mounting holes on socket cup until it is attached to the neck of Shade (E). Please make sure the Shade (E) is held well before you release your hands.

Your fixture is now assembled and ready to use. Enjoy!

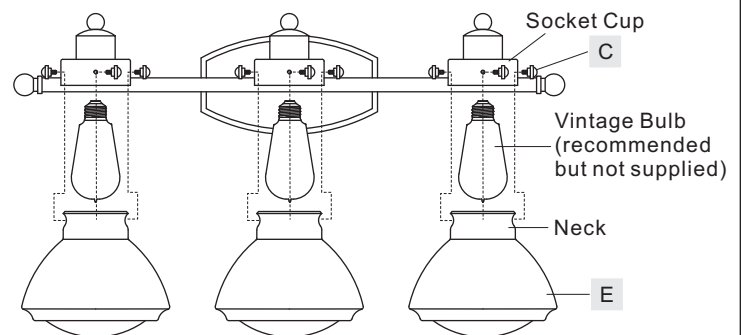
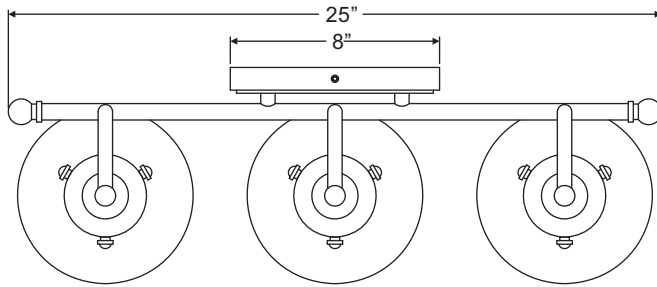
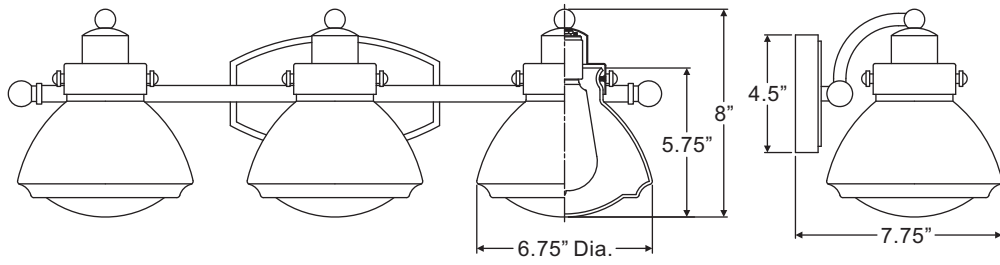
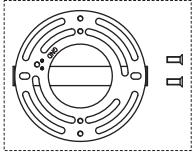

Figure 3

FINISH: PALLADIAN BRONZE



NOTE: ALL DIMENSIONS ARE ROUNDED UP TO THE NEAREST 1/4"