

Dining Chair

Assembly Guide

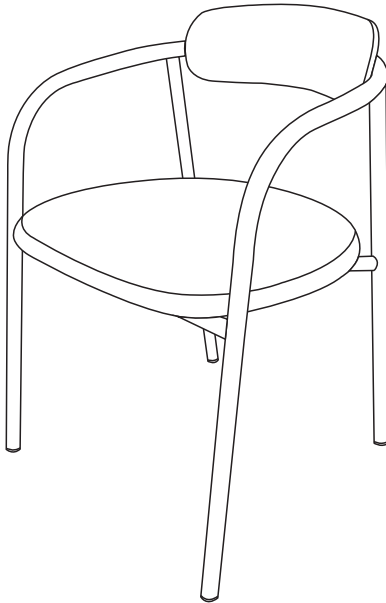

IMPORTANT: please read these instructions fully before starting assembly



**SAFETY AND
CARE ADVICE**



NO POWER TOOLS

- Check you have all the components and tools listed
- Remove all fittings from their bags and separate into groups
- We do not recommend use of power tools - this could damage the unit. Only use hand screwdrivers and Allen keys
- Keep children and animals away from the work area, small parts could cause choking if swallowed
- Make sure you have enough space to lay out the parts before starting
- Assemble the item as close to its final position (same room) as possible
- Do not over tighten the nuts to avoid damage to the threads
- Only clean using a damp cloth and mild detergent. Do not use bleach or abrasive cleaners
- From time to time, check there are no loose screws in this unit
- This product should not be discarded with household waste. Take to your local authority waste disposal centre
- Unless otherwise stated, this product is designed for domestic use and is not certified for commercial or contract settings.

IMPORTANT INFORMATION



20 Minute
Build



Two Person
Build







Max Weight
Capacity
120kg

Note: Assembly estimates are approximate and can differ based on the specific environment and user experience.

WHAT'S IN THE BOX

Note: the quantities are the correct amount to complete the assembly. In some cases more fixings may be supplied than are required.

Label	Part Name	Drawing	Quantity
1	Leg		1
2	Chair Seat		1

Label	Hardware Description	Drawing	Size (mm)	Quantity
A	Washer		M6 x 16	4
B	Screw		M6 x 45	4
C	Allen Key		M5	1



Note:

- Use a clear, flat surface to avoid bumps or scratches before assembling.
- Insert all fixings loosely at first to allow for alignment; only tighten them once everything is properly positioned, as some adjustment may be required.
- Avoid over-tightening, as this may damage the parts.
- Seek assistance when moving large or heavy parts

STEP 1

Attach the chair seat [2] to the legs [1]. You may find it easier using the edge of a table to assist. Align the pre-drilled holes and secure the chair seat using 1x washer [A] + 1x Screw [B] per hole (4 of each in total). Fully tighten with Allen key [C].



A		X4
B		X4
C		X1

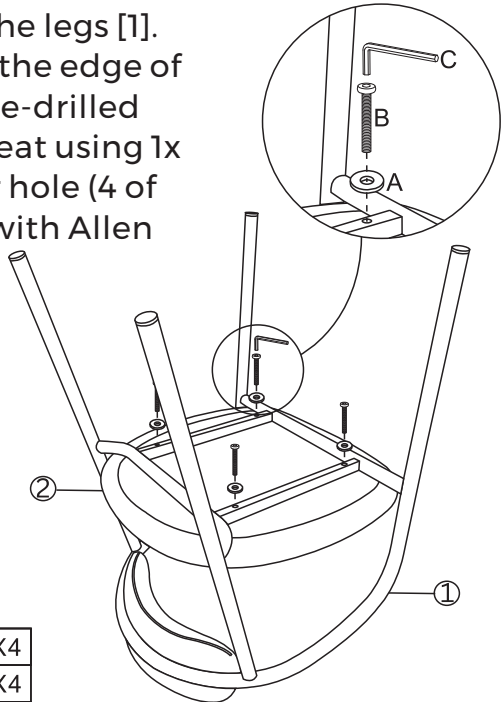

STEP 2

Carefully and with help,
place the chair on its feet
and check for stability.

Your new chair is now
ready to use!

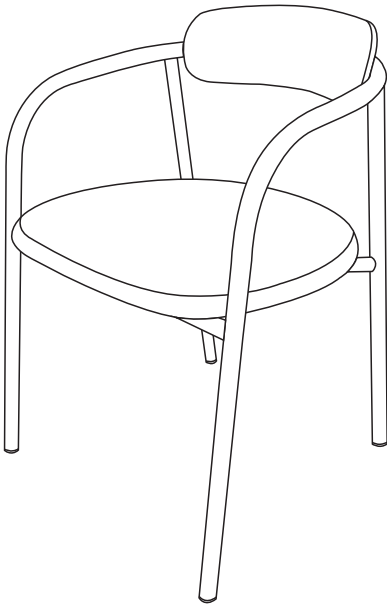

Please ensure any and all fixings and fittings are FULLY tightened before using this product



our 2 year GUARANTEE

Our products come with a 2 year guarantee, giving you extra peace of mind when shopping with us!

What the guarantee covers



PRE-INSERTED FIXINGS
e.g. loose metal threads



FAULTY JOINTS
e.g. legs bending



EXTERNAL FIXING FAULTS
e.g. metal discs removing
from table top



STRUCTURAL INTEGRITY
e.g. the frame of the
product
