

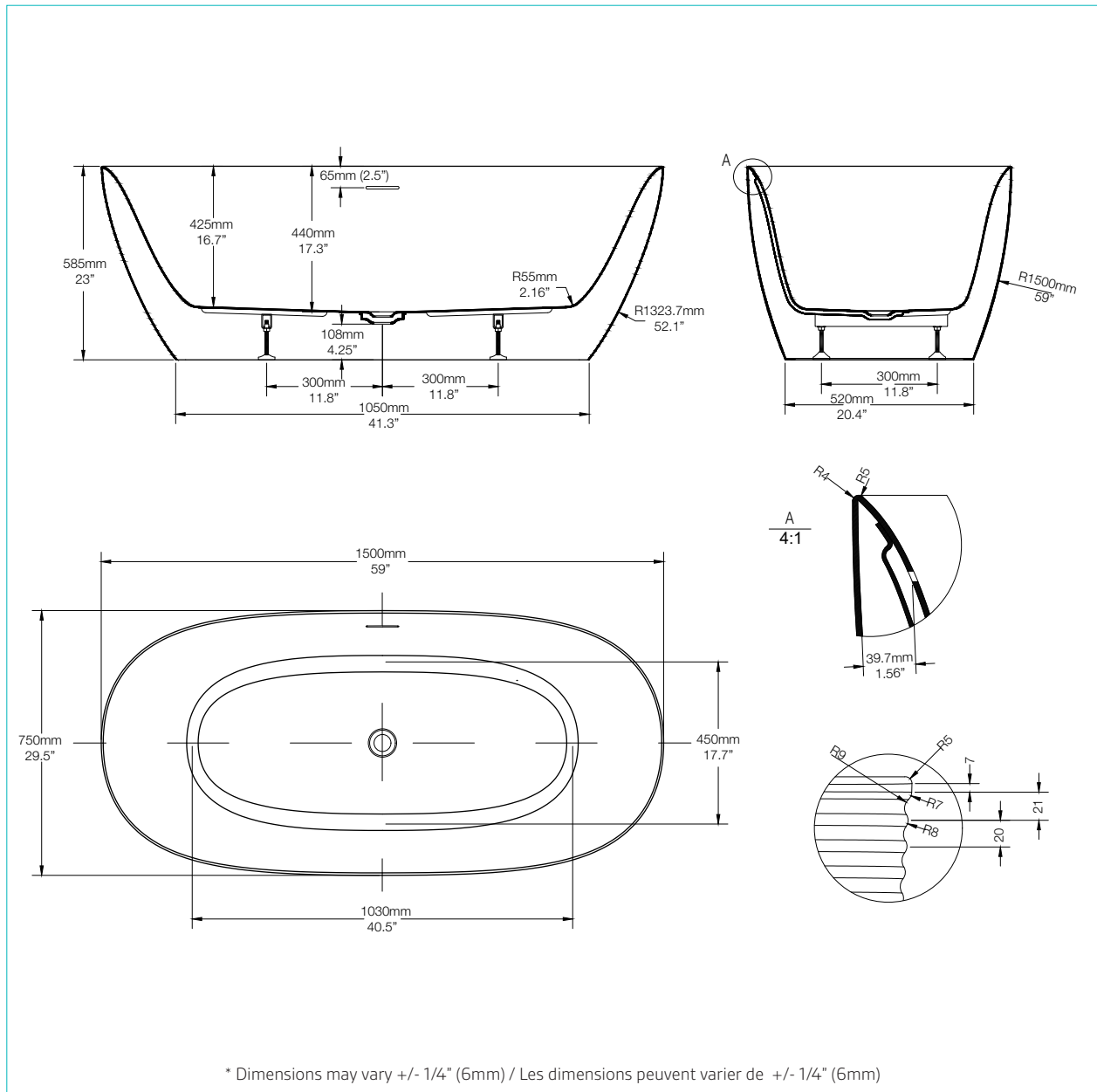

**FREESTANDING  
BATHTUBS**

**BAINOIRES  
AUTOPORTANTES**

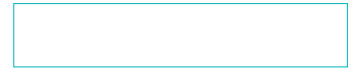

DIMENSIONS		WEIGHT POIDS		MATERIAL MATERIEL		OVERFLOW HEIGHT HAUTEUR DU TROP-PLEIN		WATER CAPACITY CAPACITÉ DE L'EAU	
59 x 29.5 x 23" 1500 x 750 x 585 mm		73 lbs 33 Kg		Acrylic Acrylique		14.7" 375mm		59 gal 233 lts	
FINISH FINITION		DRAIN LOCATION LOCATION DU DRAIN		PIECES PIÈCES		<b>COMPLIANCE CERTIFICATIONS:</b> Uniform Plumbing Code National Plumbing Code of Canada CSA B45.5-17/IAPMO Z124-2017			
Black Matte Noir Mat		Center Centré		1 pc					



**FREESTANDING  
BATHTUBS**

**BAIGNOIRES  
AUTOPORTANTES**

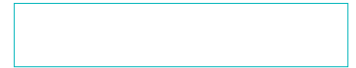

Pure acrylic construction reinforced by fiberglass  
*Construction en acrylique renforcée de fibre de verre*

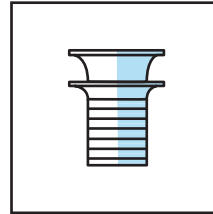

Pop-up drain included  
*Drain pop-up inclus*

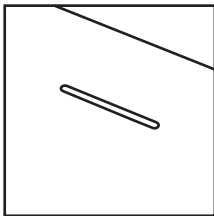

Linear overflow  
*Trop plein linéaire*



cUPC Certified  
*Certifié cUPC*

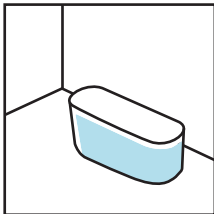

Freestanding installation  
*Installation autoportante*

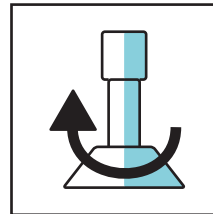

Adjustable feet  
*Pieds ajustables*