

ASSEMBLY INSTRUCTION

NOTES:

- Do not skip any step.
- Do not fully tight screws until all the bed parts are assembled.









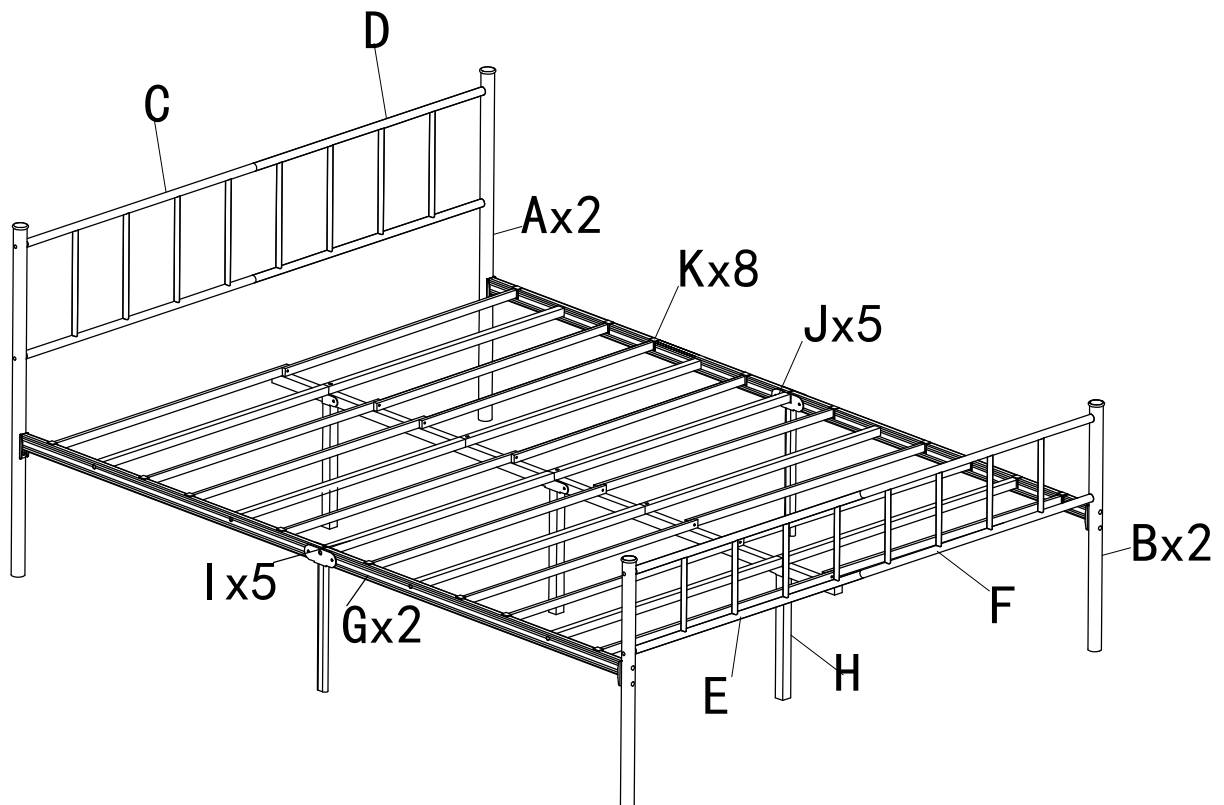

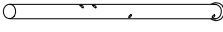
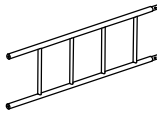
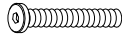
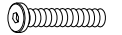



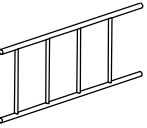
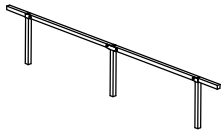

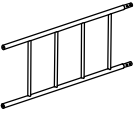
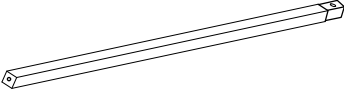

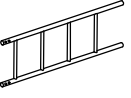
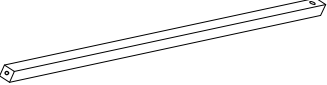

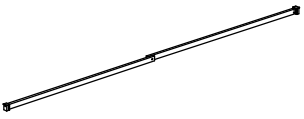
WARNING:

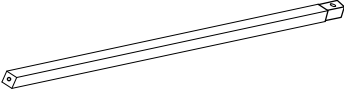

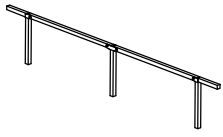
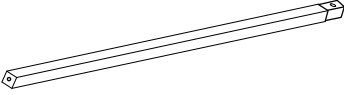
- WARNING FOR YOUNG CHILDREN**-This product contains small components, please ensure that they are kept away from small children while assembling.

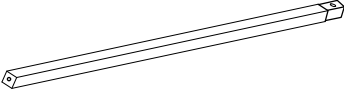
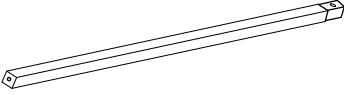
Warranty Information:

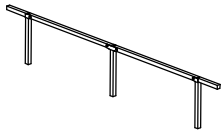
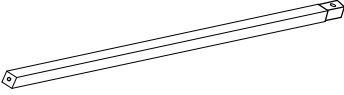
- We warrant this product to be free from defects in materials. If you have any query about bed

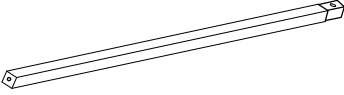
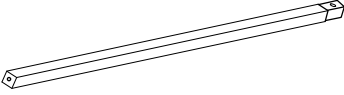
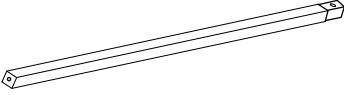
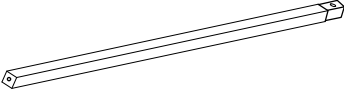
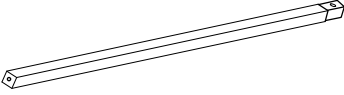
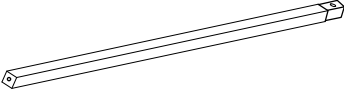
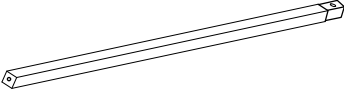
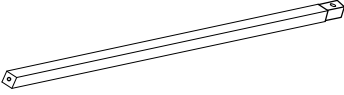
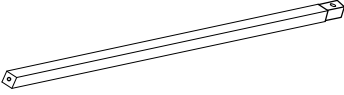
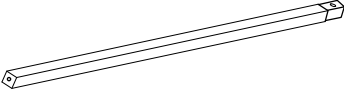
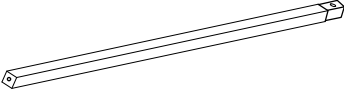
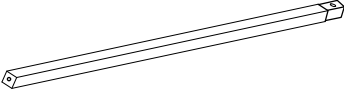
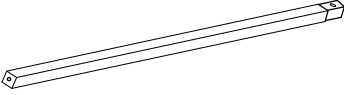
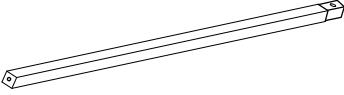
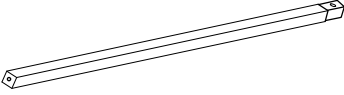
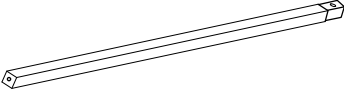
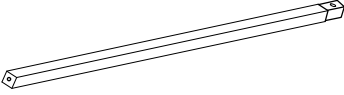
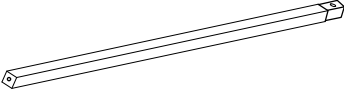
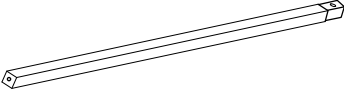
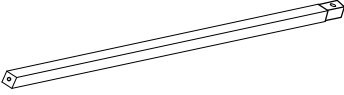
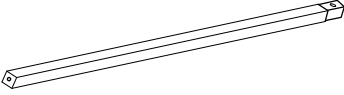
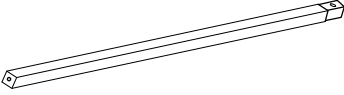
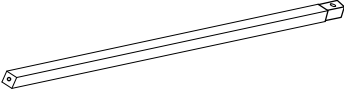
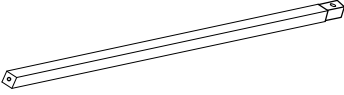
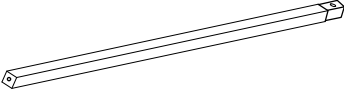
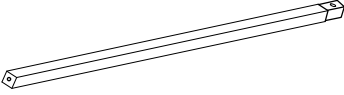
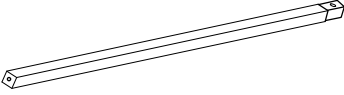
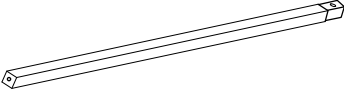
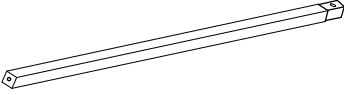
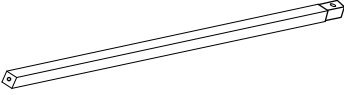
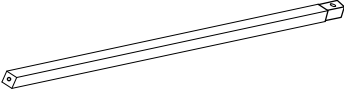
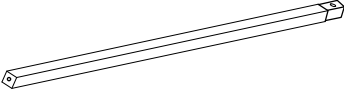
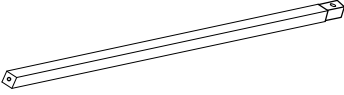
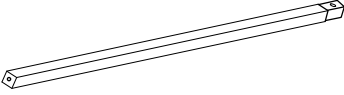
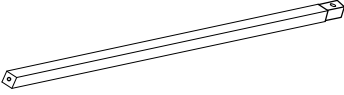
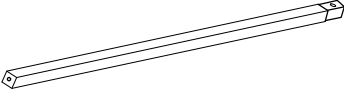
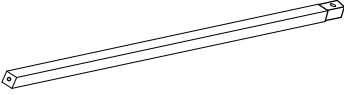
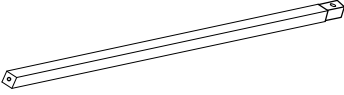
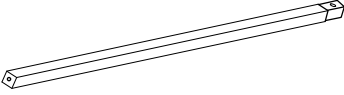
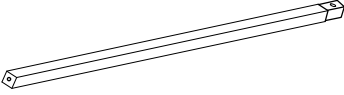
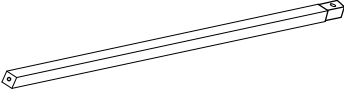



<p style="text-align: center;">A</p>  <p style="text-align: center;">2PCS</p>	<p style="text-align: center;">F</p>  <p style="text-align: center;">1PC</p>	aa	 M6×55mm	21
		bb	 M8×50mm	8
		cc	 M6×12mm	8
<p style="text-align: center;">B</p>  <p style="text-align: center;">2PCS</p>	<p style="text-align: center;">G</p>  <p style="text-align: center;">2PCS</p>	dd	 4×4mm	1
<p style="text-align: center;">C</p>  <p style="text-align: center;">1PC</p>	<p style="text-align: center;">H</p>  <p style="text-align: center;">1PC</p>	ee		16
<p style="text-align: center;">D</p>  <p style="text-align: center;">1PC</p>	<p style="text-align: center;">I</p>  <p style="text-align: center;">5PCS</p>	ff	 M6×30mm	2
<p style="text-align: center;">E</p>  <p style="text-align: center;">1PC</p>	<p style="text-align: center;">J</p>  <p style="text-align: center;">5PCS</p>	SPARE	aa	2
<p style="text-align: center;">F</p>  <p style="text-align: center;">1PC</p>	<p style="text-align: center;">K</p>  <p style="text-align: center;">8PCS</p>	bb		1
<p style="text-align: center;">G</p>  <p style="text-align: center;">2PCS</p>	<p style="text-align: center;">L</p>  <p style="text-align: center;">5PCS</p>	cc		1
<p style="text-align: center;">H</p>  <p style="text-align: center;">1PC</p>	<p style="text-align: center;">M</p>  <p style="text-align: center;">5PCS</p>	ee		1
<p style="text-align: center;">I</p>  <p style="text-align: center;">5PCS</p>	<p style="text-align: center;">N</p>  <p style="text-align: center;">5PCS</p>	ff		1
<p style="text-align: center;">J</p>  <p style="text-align: center;">1PC</p>	<p style="text-align: center;">O</p>  <p style="text-align: center;">5PCS</p>	gg		2
<p style="text-align: center;">K</p>  <p style="text-align: center;">2PCS</p>	<p style="text-align: center;">P</p>  <p style="text-align: center;">5PCS</p>			
<p style="text-align: center;">L</p>  <p style="text-align: center;">5PCS</p>	<p style="text-align: center;">Q</p>  <p style="text-align: center;">5PCS</p>			
<p style="text-align: center;">M</p>  <p style="text-align: center;">5PCS</p>	<p style="text-align: center;">R</p>  <p style="text-align: center;">5PCS</p>			
<p style="text-align: center;">N</p>  <p style="text-align: center;">5PCS</p>	<p style="text-align: center;">S</p>  <p style="text-align: center;">5PCS</p>			
<p style="text-align: center;">O</p>  <p style="text-align: center;">5PCS</p>	<p style="text-align: center;">T</p>  <p style="text-align: center;">5PCS</p>			
<p style="text-align: center;">P</p>  <p style="text-align: center;">5PCS</p>	<p style="text-align: center;">U</p>  <p style="text-align: center;">5PCS</p>			
<p style="text-align: center;">Q</p>  <p style="text-align: center;">5PCS</p>	<p style="text-align: center;">V</p>  <p style="text-align: center;">5PCS</p>			
<p style="text-align: center;">R</p>  <p style="text-align: center;">5PCS</p>	<p style="text-align: center;">W</p>  <p style="text-align: center;">5PCS</p>			
<p style="text-align: center;">S</p>  <p style="text-align: center;">5PCS</p>	<p style="text-align: center;">X</p>  <p style="text-align: center;">5PCS</p>			
<p style="text-align: center;">T</p>  <p style="text-align: center;">5PCS</p>	<p style="text-align: center;">Y</p>  <p style="text-align: center;">5PCS</p>			
<p style="text-align: center;">U</p>  <p style="text-align: center;">5PCS</p>	<p style="text-align: center;">Z</p>  <p style="text-align: center;">5PCS</p>			
<p style="text-align: center;">V</p>  <p style="text-align: center;">5PCS</p>	<p style="text-align: center;">AA</p>  <p style="text-align: center;">5PCS</p>			
<p style="text-align: center;">W</p>  <p style="text-align: center;">5PCS</p>	<p style="text-align: center;">AB</p>  <p style="text-align: center;">5PCS</p>			
<p style="text-align: center;">X</p>  <p style="text-align: center;">5PCS</p>	<p style="text-align: center;">AC</p>  <p style="text-align: center;">5PCS</p>			
<p style="text-align: center;">Y</p>  <p style="text-align: center;">5PCS</p>	<p style="text-align: center;">AD</p>  <p style="text-align: center;">5PCS</p>			
<p style="text-align: center;">Z</p>  <p style="text-align: center;">5PCS</p>	<p style="text-align: center;">AE</p>  <p style="text-align: center;">5PCS</p>			
<p style="text-align: center;">AA</p>  <p style="text-align: center;">5PCS</p>	<p style="text-align: center;">AF</p>  <p style="text-align: center;">5PCS</p>			
<p style="text-align: center;">AB</p>  <p style="text-align: center;">5PCS</p>	<p style="text-align: center;">AG</p>  <p style="text-align: center;">5PCS</p>			
<p style="text-align: center;">AC</p>  <p style="text-align: center;">5PCS</p>	<p style="text-align: center;">AH</p>  <p style="text-align: center;">5PCS</p>			
<p style="text-align: center;">AD</p>  <p style="text-align: center;">5PCS</p>	<p style="text-align: center;">AI</p>  <p style="text-align: center;">5PCS</p>			
<p style="text-align: center;">AE</p>  <p style="text-align: center;">5PCS</p>	<p style="text-align: center;">AJ</p>  <p style="text-align: center;">5PCS</p>			

cc		M6×12mm	4
dd		4×4mm	1

Note: For easy setup intention, do not tighten screws during the installation process

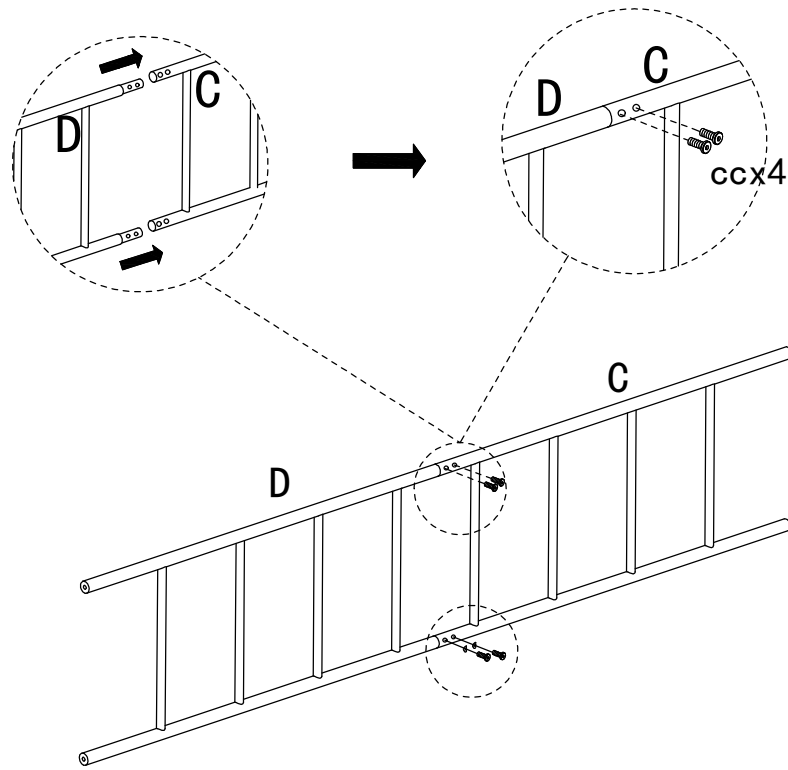
Step 1



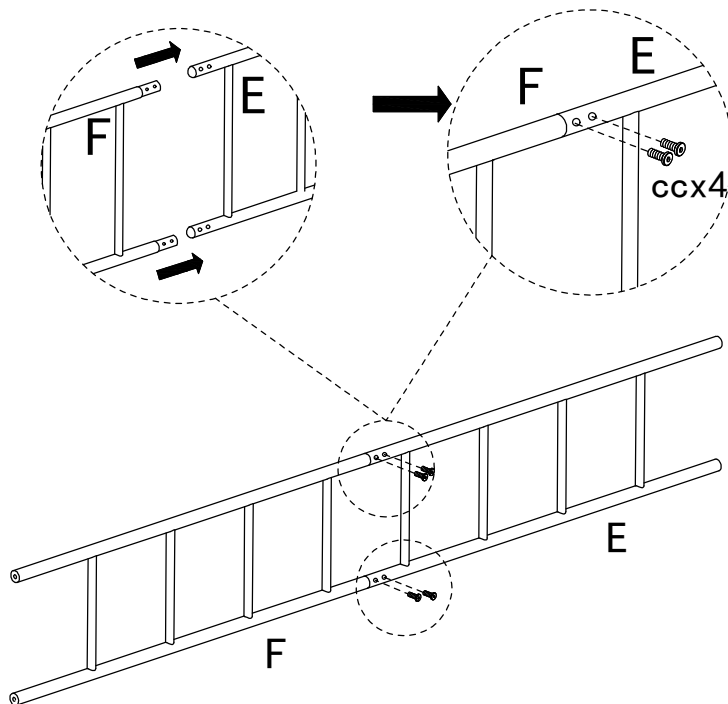

cc		M6×12mm	4
dd		4×4mm	1

Step 2



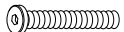

Step 3

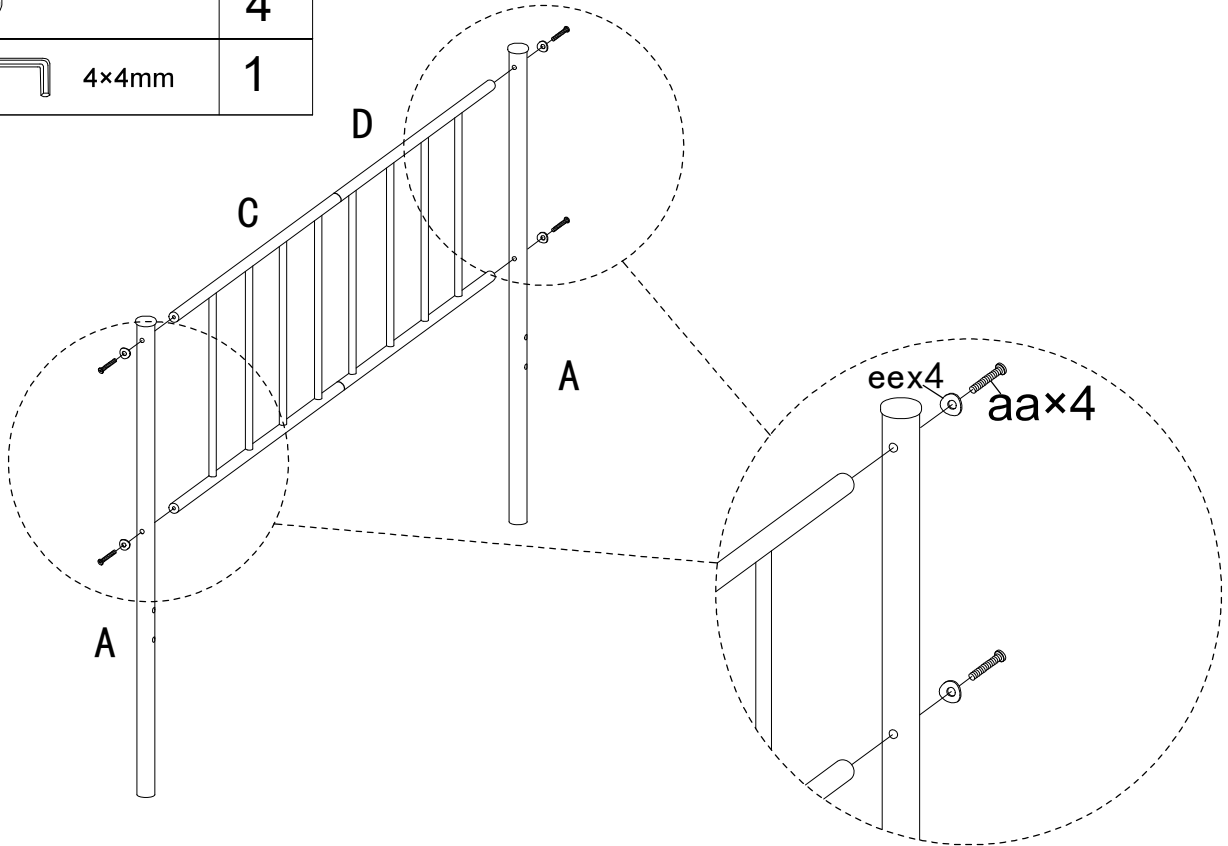
aa	 M6×55mm	4
ee		4
dd	 4×4mm	1



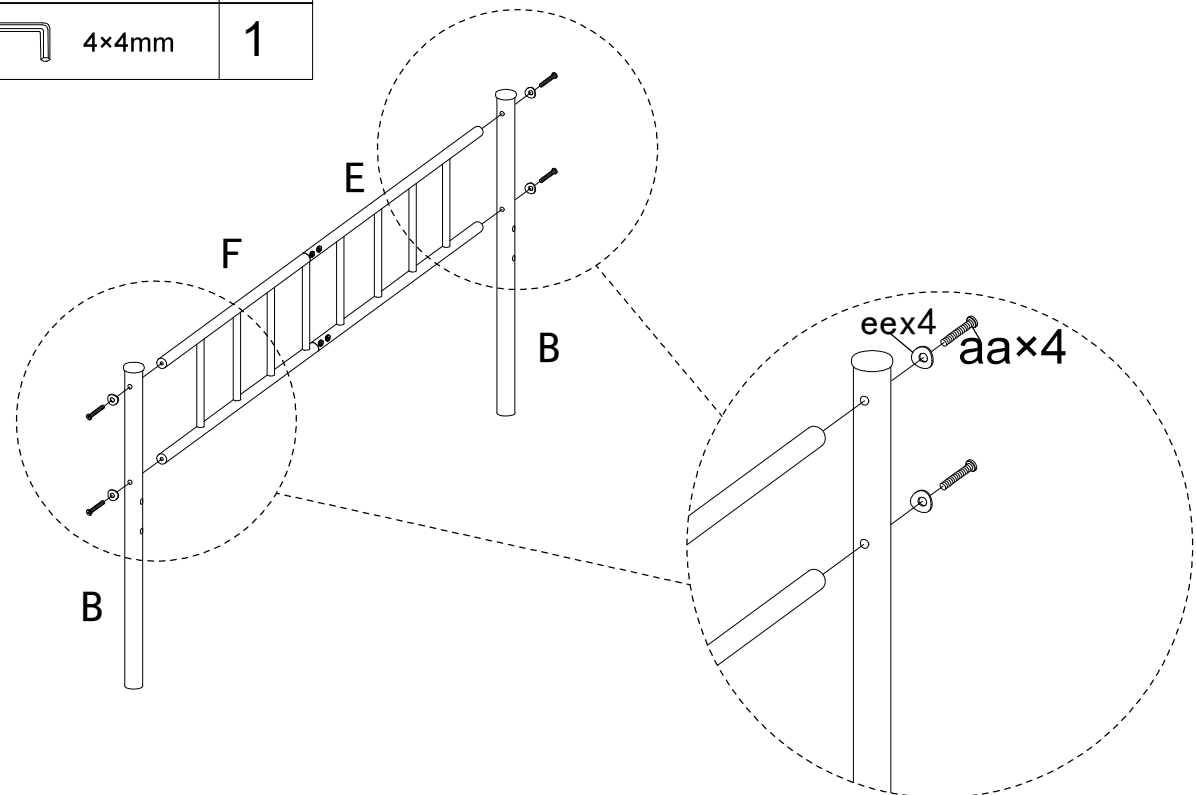

Step 4

aa	 M6×55mm	4
ee		4
dd	 4×4mm	1

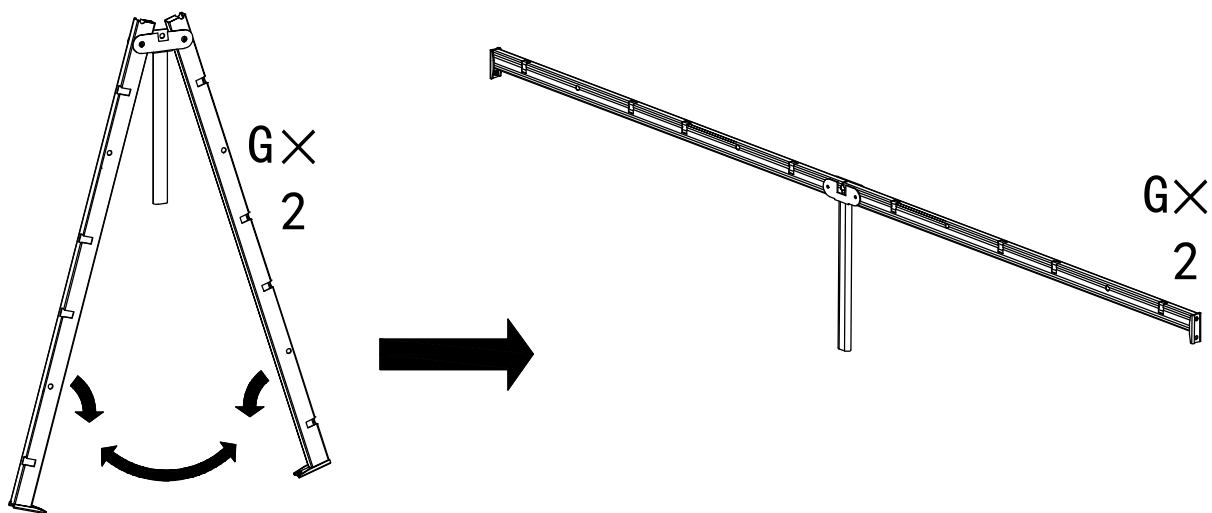

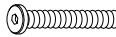

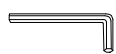
bb	 M8×50mm	8
ee		8
dd	 4×4mm	1

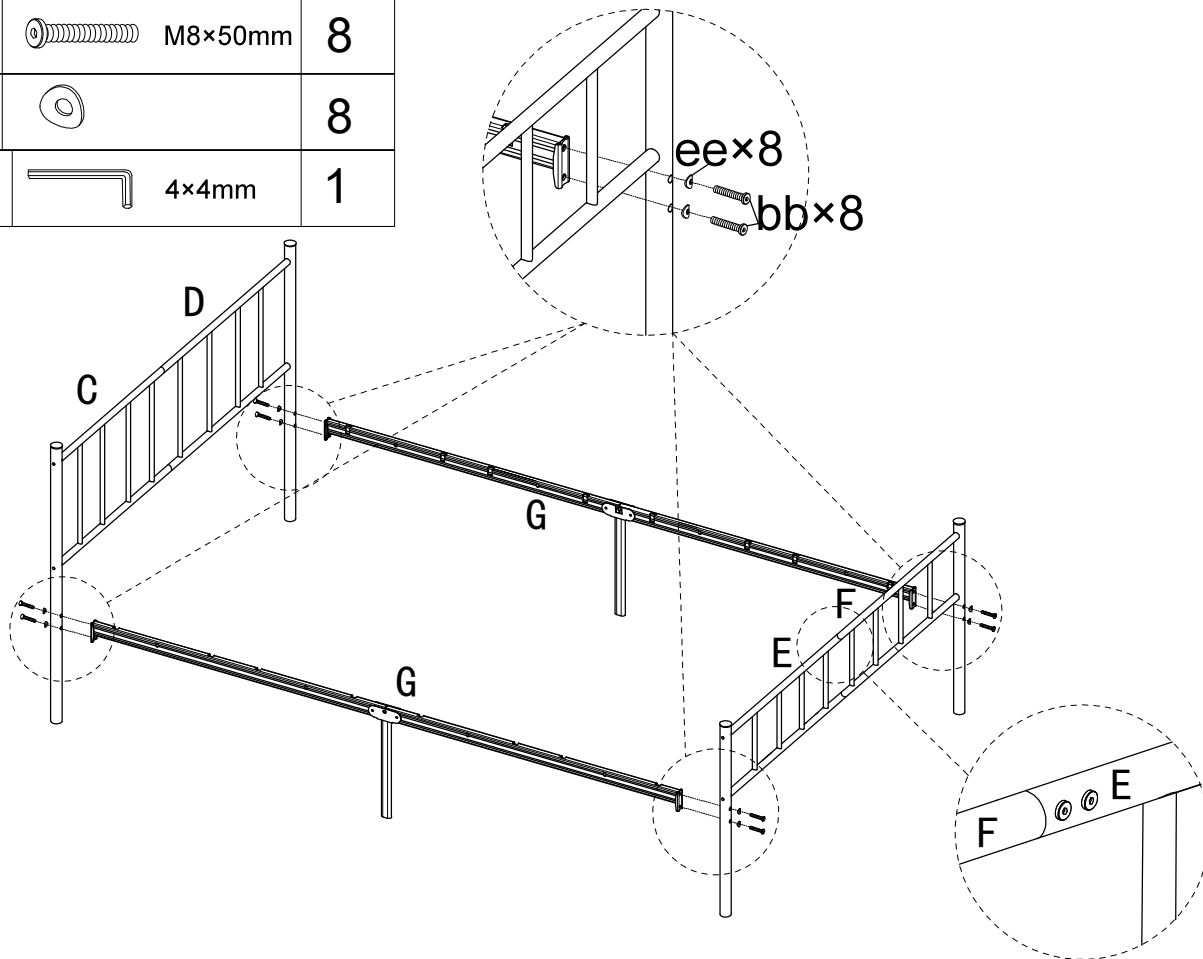

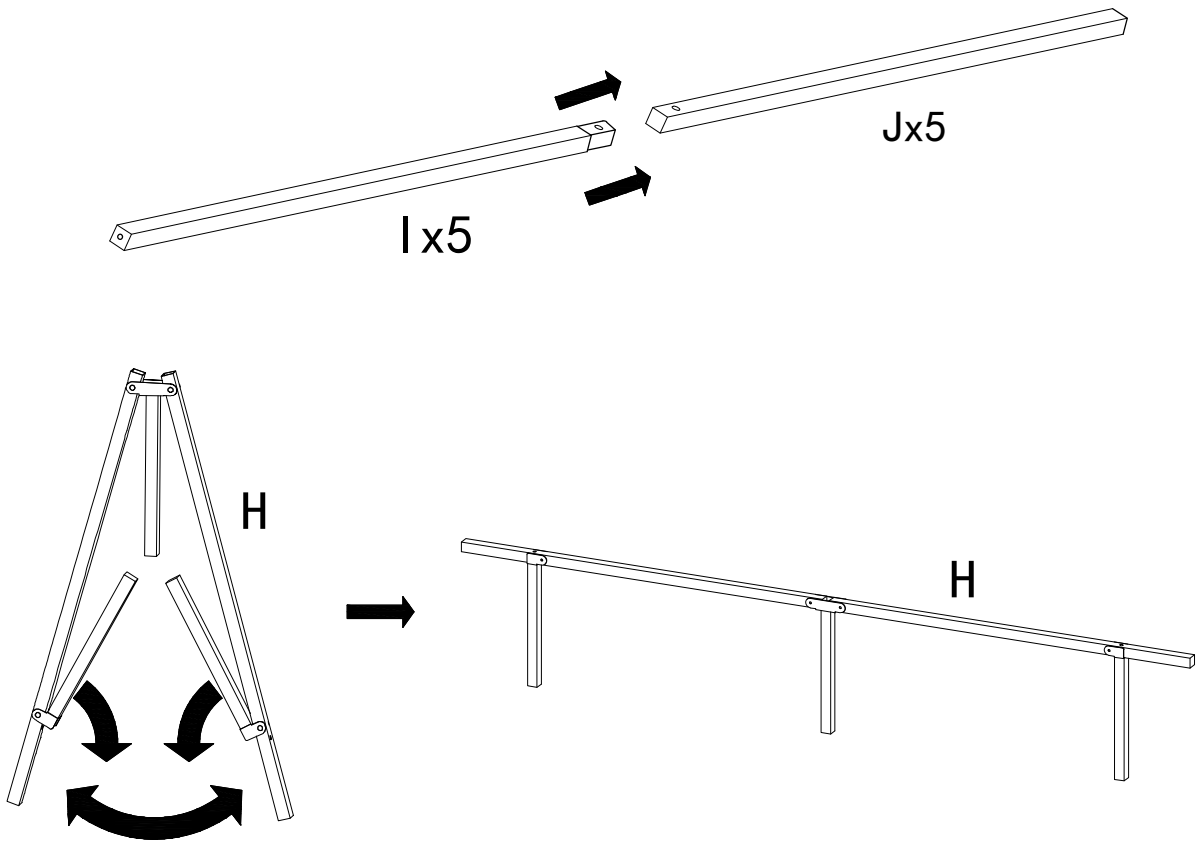

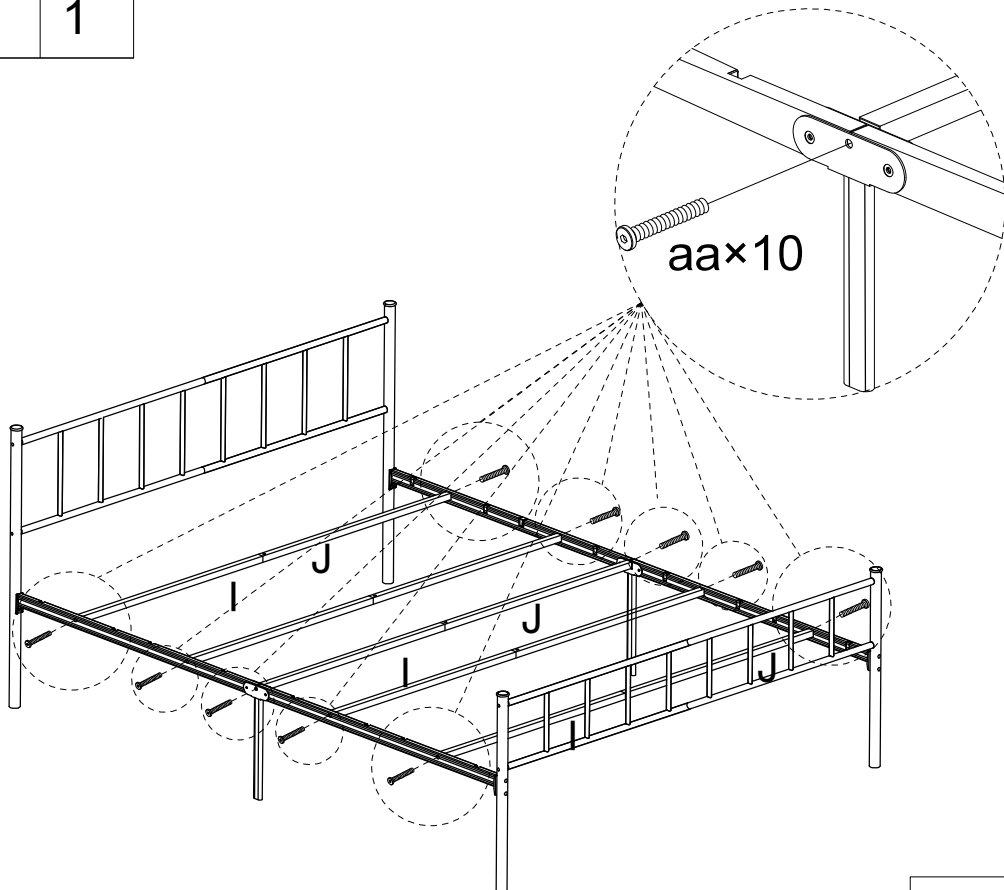

aa  M6x55mm 10

dd  4x4mm 1



aa	 M6×55mm	3	ff	 M6×30mm	2
dd	 4×4mm	1			

Step 9

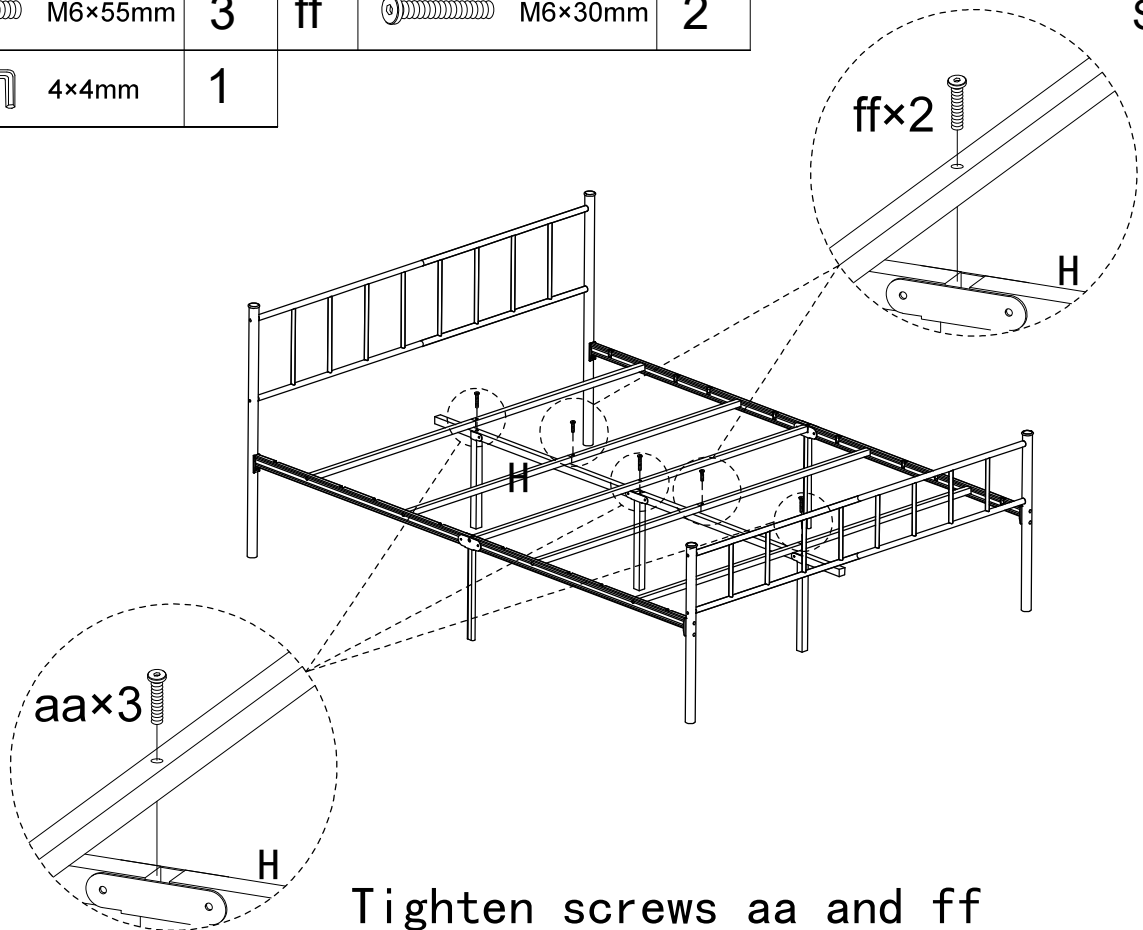

Tighten screws aa and ff

Step 10

