

KIMORI 3 SHELF BAR CABINET

DESIGN # SFV6611A

Assembly Instructions

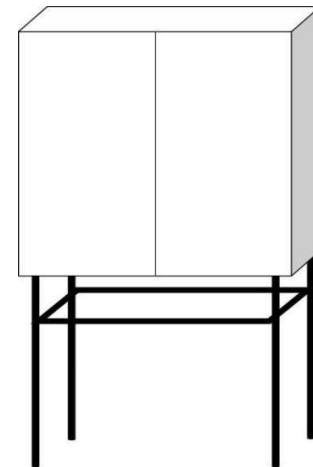

Need help?

Feel free to contact us via email or call if you have any specific questions!

contact us:

cs@safavieh.com

866-422-9070

SAFAVIEH
C O U T U R E

Thanks for bringing Safavieh Couture into your home

Everything we make is incredibly simple to set up, including your new bar cabinet. You won't need any additional tools.

Parts list

A x 1
Cabinet

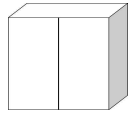

B x 1
Right Side Frame - Stand



C x 1
Right Side Frame - Stand



D x 2
Axle



Hardware list

HW1 x 12
Allen Bolt 5 X 1 X 15 MM



HW2 x 1
Allen Key 4MM

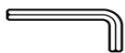

1

Place the cabinet (A) upside down on a soft, padded surface to protect its finish and ensure stability.

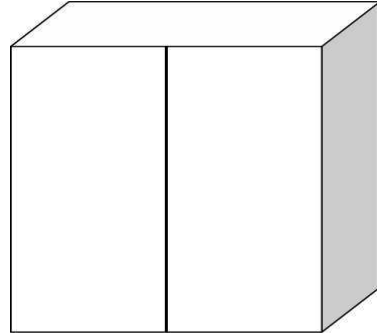

2

Align the screw holes on the Axle (D) to the support tabs on the left and right side frames (B&C). Use the Allen Key (HW2) to screw in the Allen Bolts (HW1) as shown. Firmly tighten the bolts.

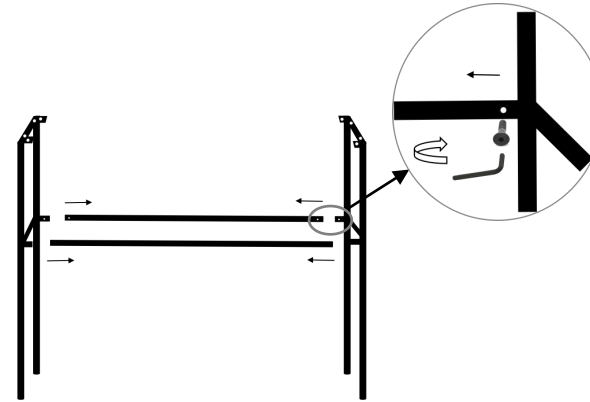

3

Place the cabinet (A) upside down on a soft surface. Align the screw holes on the bottom of the cabinet (A) to the screw holes on the top of the assembled stand. Use the Allen key (HW2) to screw in the Allen bolts (HW1) to attach the stand to the cabinet (A). Firmly tighten the bolts.

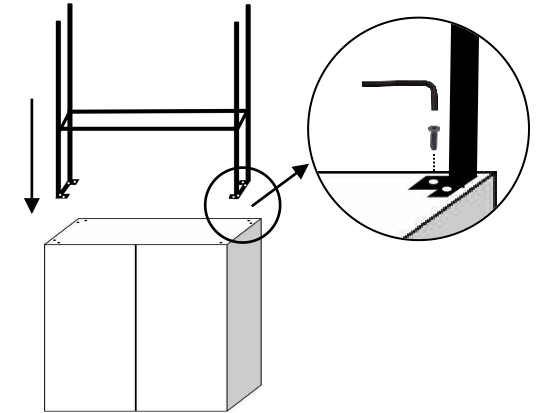

4

Carefully turn the cabinet upright. Place the cabinet in the place where you will use it. We'd love to see it – just tag us (we're @safavieh) and use the hashtag #safavieh on Instagram!

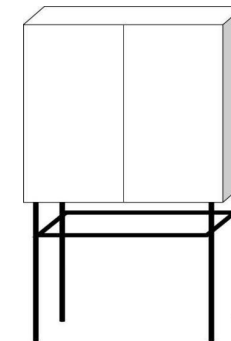

@safavieh