

# **INSTALLATION**

## *Product Manual*

Version: 510017US-00-25A-KD

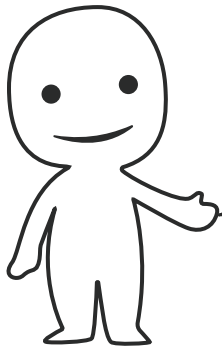

Please prepare the following tools

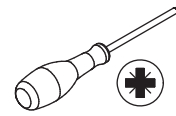
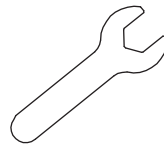

When installing, please carefully confirm whether each screw corresponds to the manual, accessories with similar shapes can be distinguished by size

A x 6

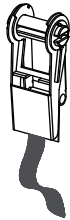

B x 4



C x 6

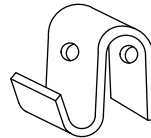

D x 2

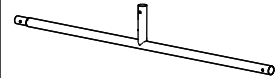

E x 1

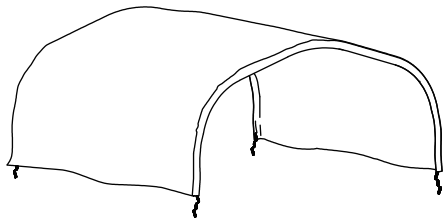

F x 2

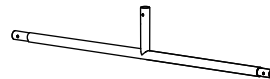

G x 16



H x 4

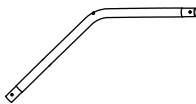

I x 4

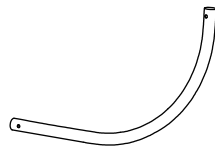

J x 10

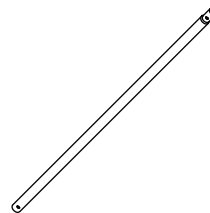

K x 5

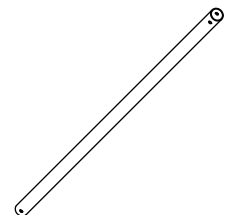

L-1 x 12

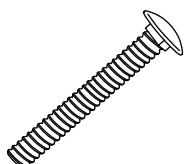

M6 x 80 mm

L-2 x 2



M6 x 55 mm

L-3 x 16

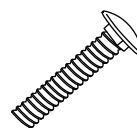

M6 x 45 mm

L-4 x 4



M6 x 40 mm

L-5 x 4

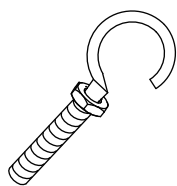

L-6 x 38

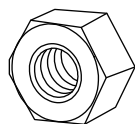

# Corral Shelter

12' x 12' / 3.6 x 3.6m

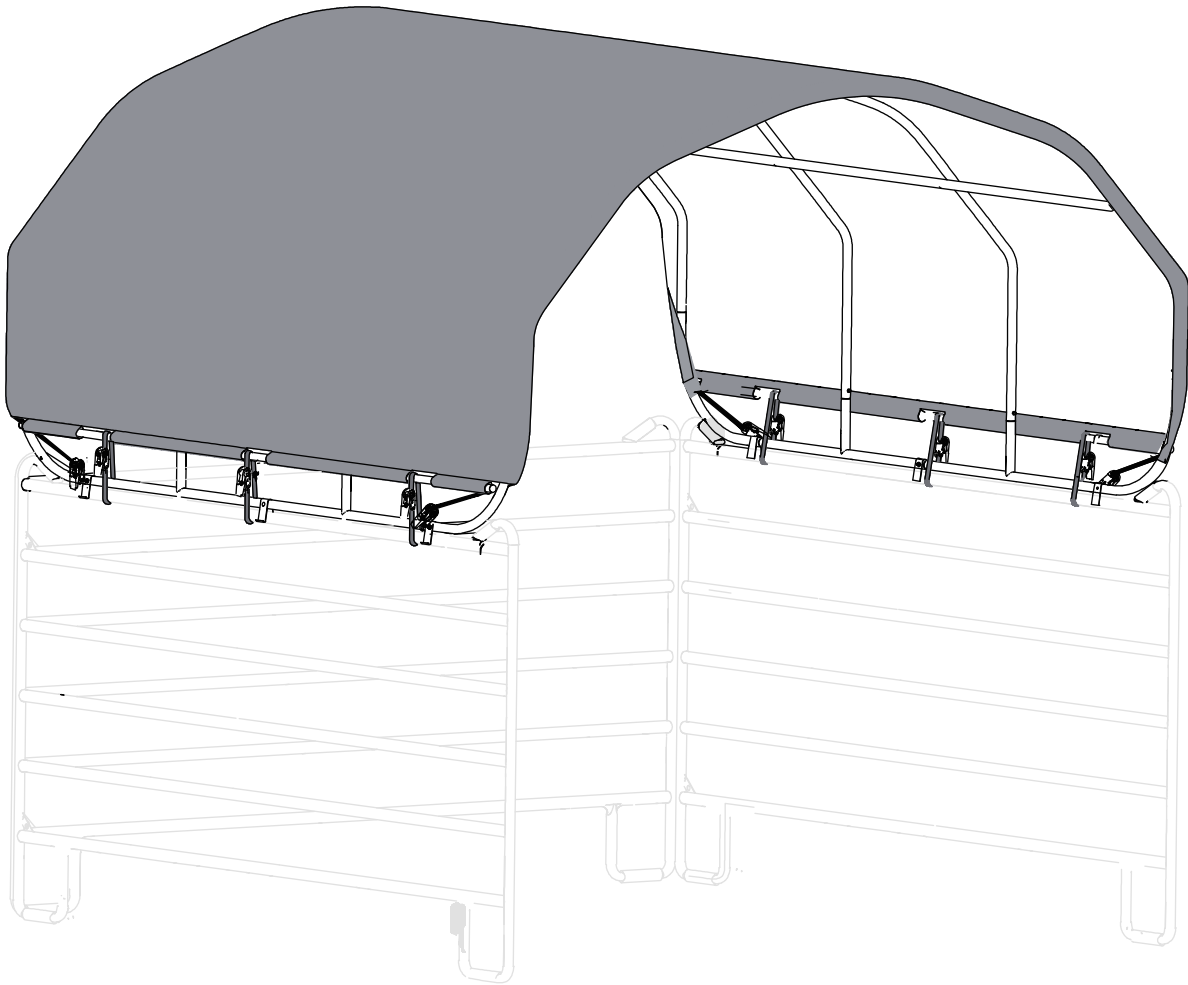

Corral panels not included.  
Les panneaux du corral ne sont pas inclus,  
No se incluyen los paneles del corral.

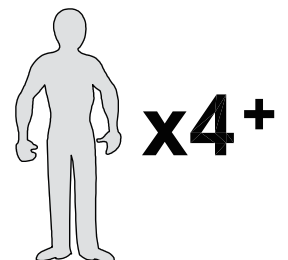

1

C x 6 	D x 2 	F x 2 	I x 4 	
L-2 x 2  M6 x 55 mm	L-5 x 4 	L-6 x 6 		

As shown in the figure, use the screws (L-5) and nuts (L-6) to connect and fix Fitting C and Fitting I to Fitting D and Fitting F respectively.

As shown in the figure, use the screws (L-2) and nuts (L-6) to connect and fix Fitting D and Fitting F with Fitting C.

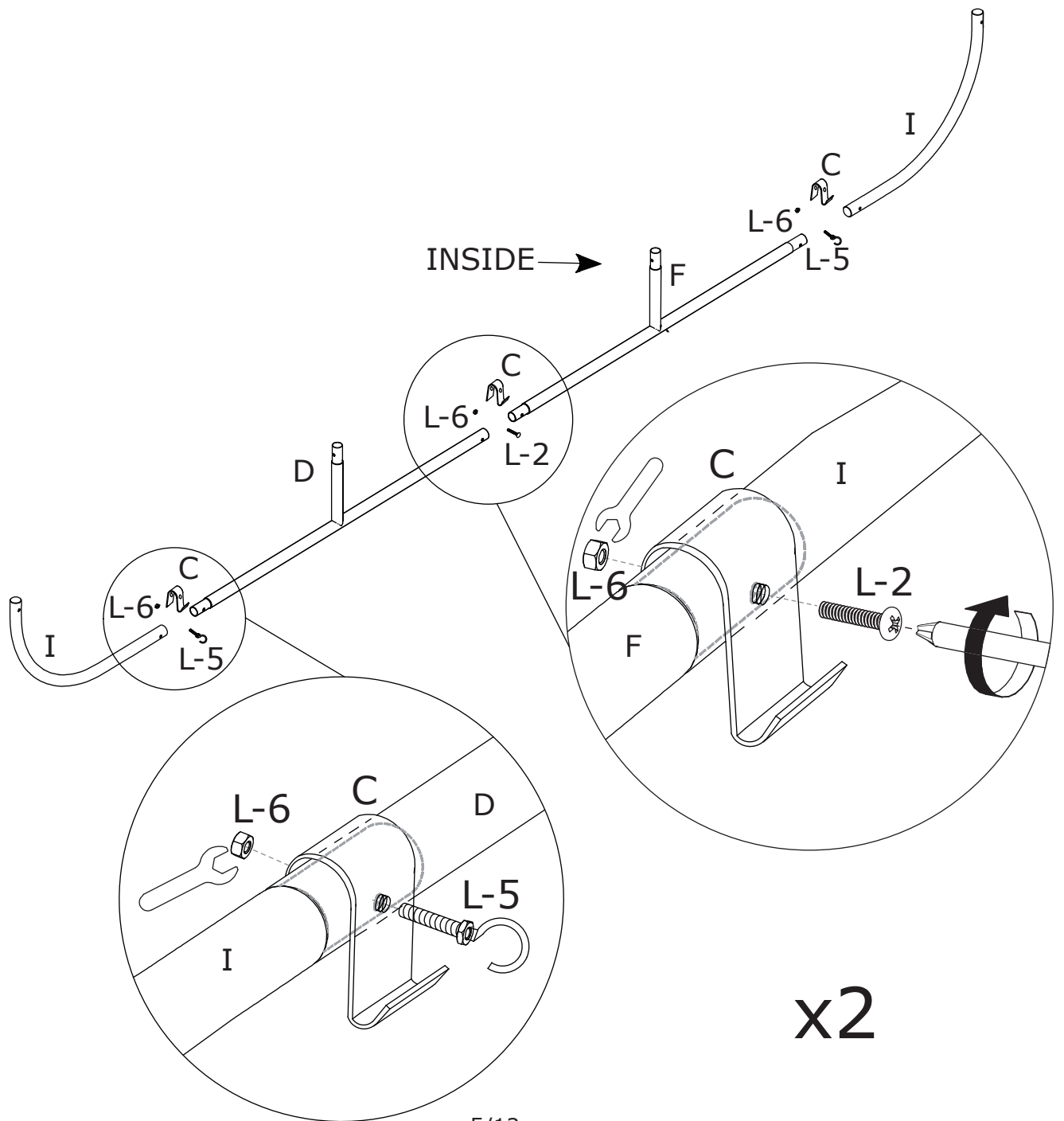

2

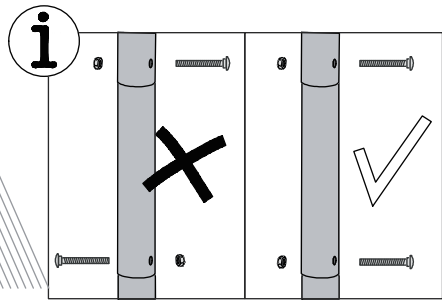
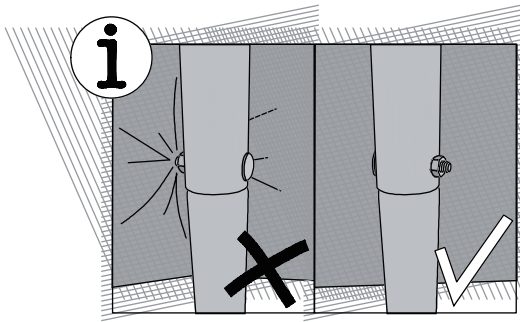
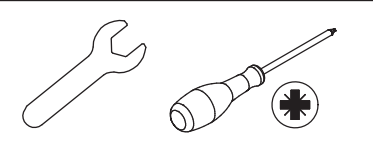
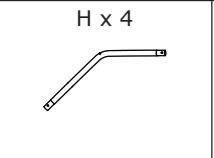
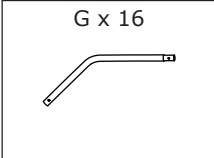

As shown in the figure, use the screws (L-3) and nuts (L-6) to connect and fix Fitting H and Fitting G.

As shown in the figure, connect the Fitting G together.

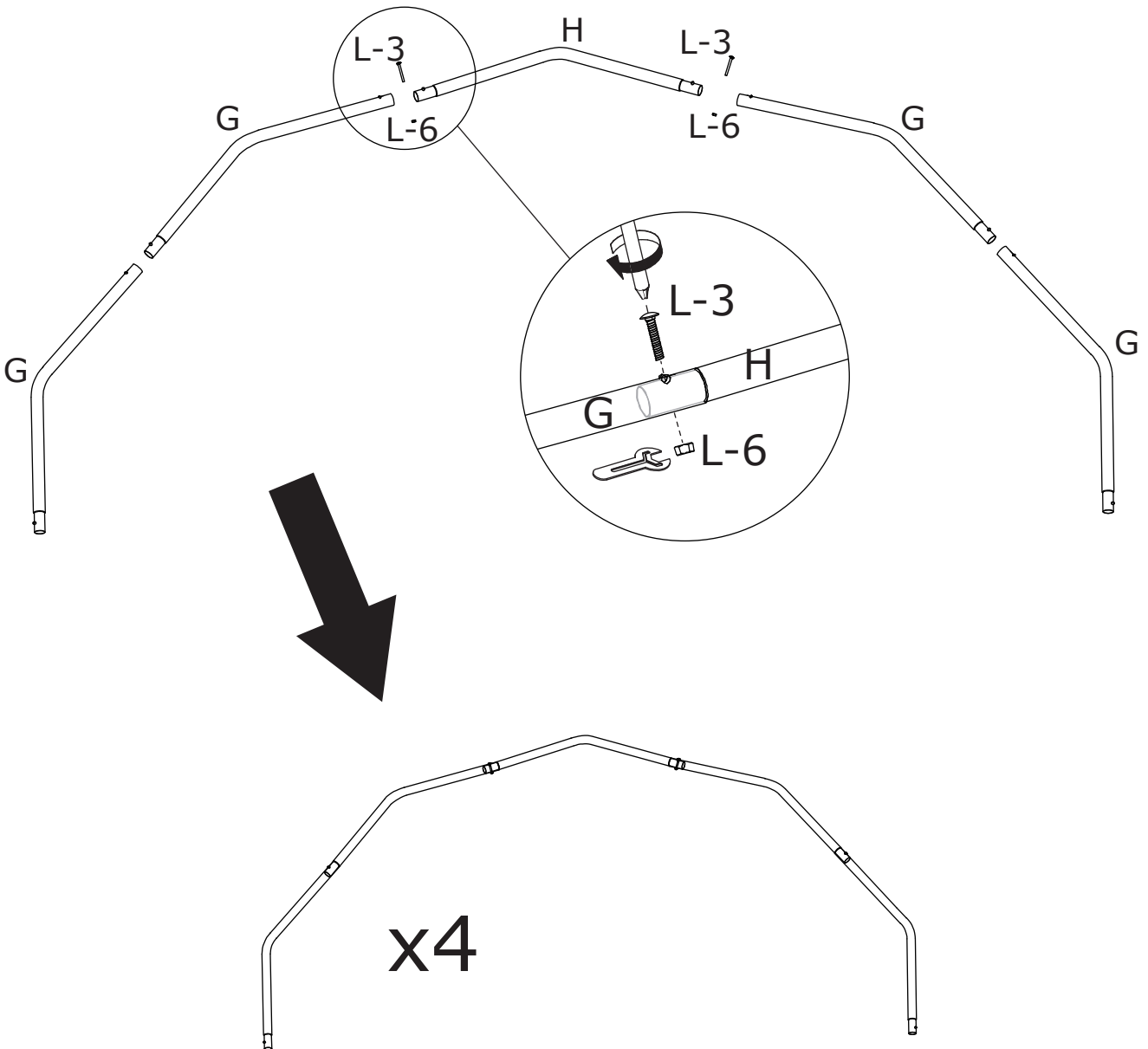

3

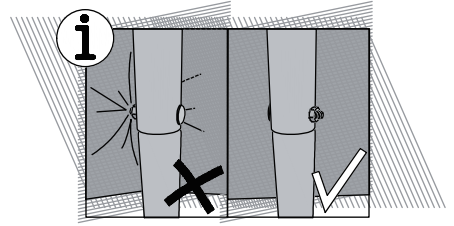
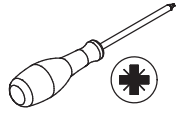
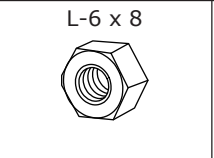
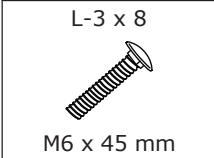

As shown in the figure, connect the two combined units together.

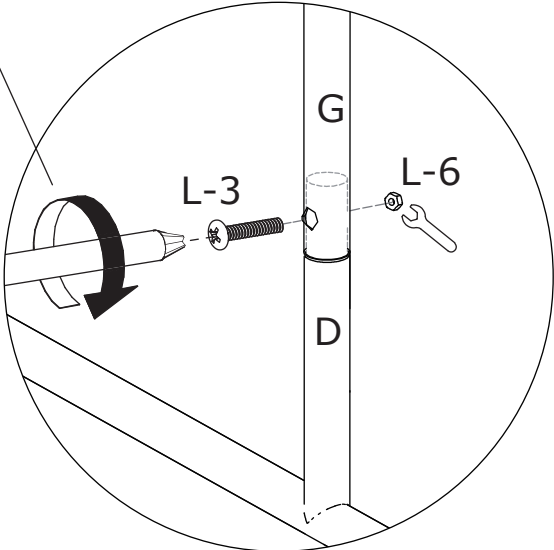
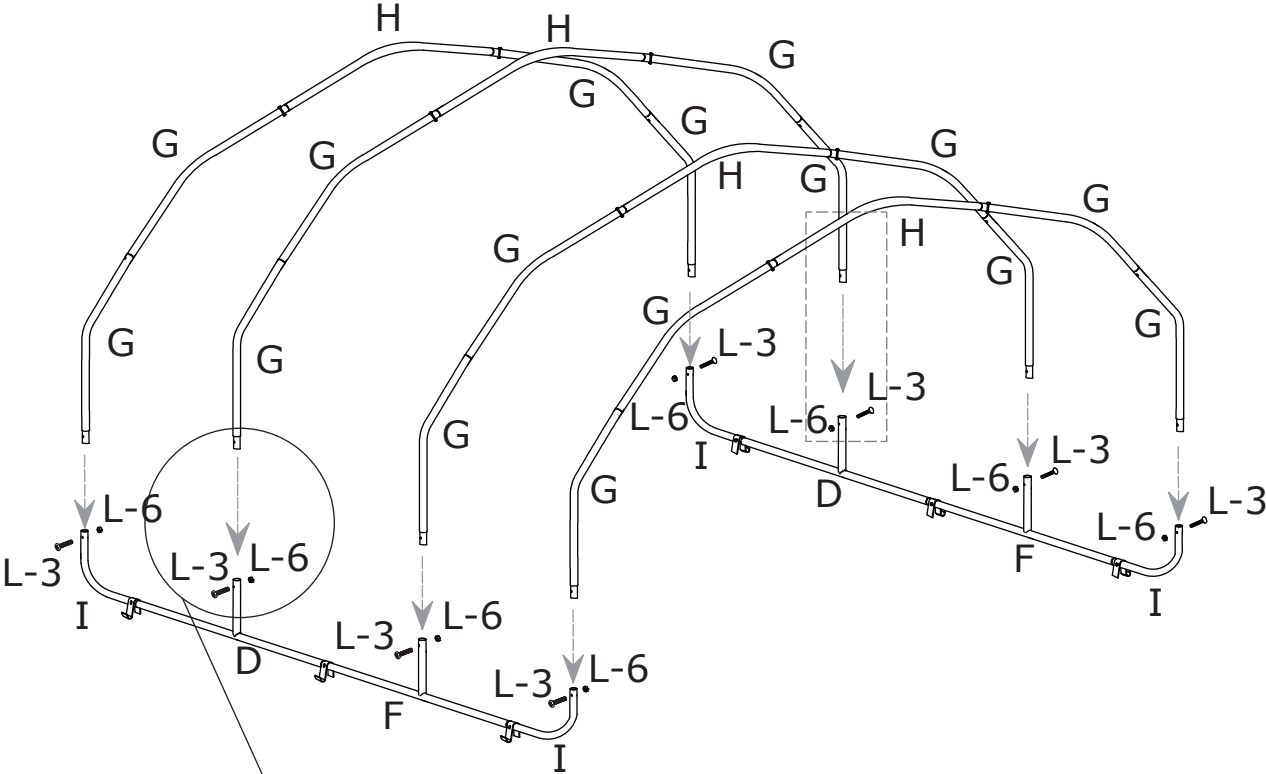

4

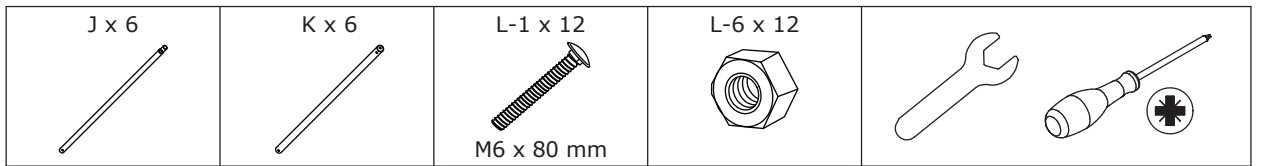

As shown in the figure, directly connect Fitting J and Fitting K.

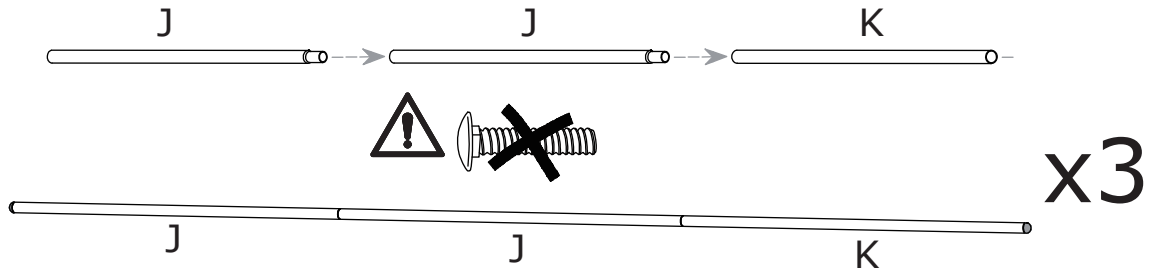

As shown in the figure, use the screws (L-1) and nuts (L-6) to connect and fix the two combined units.

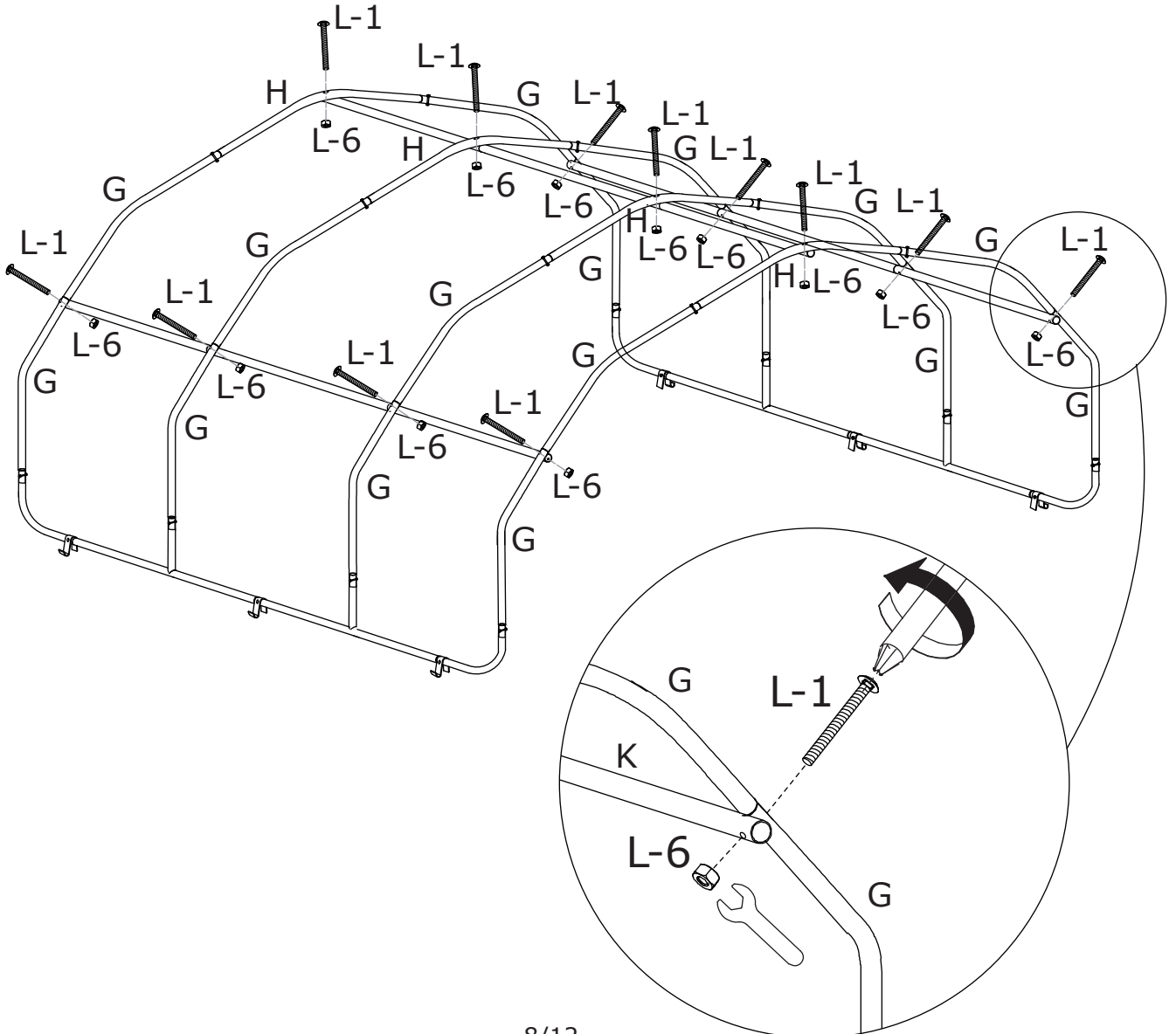

5

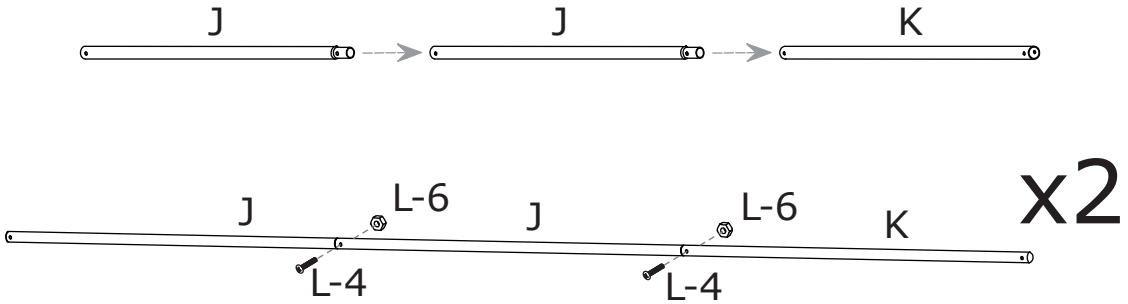
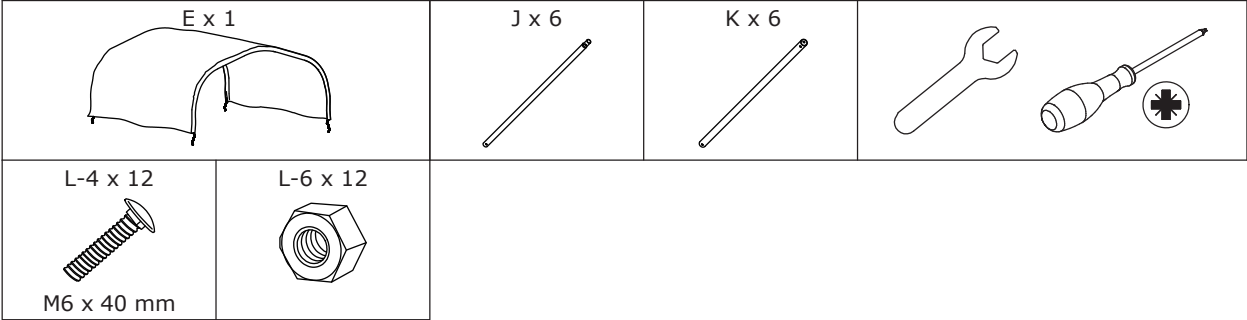

As shown in the figure, connect Fitting J and Fitting K, and then use the screws (L-4) and nuts (L-6) to connect and fix them.

As shown in the figure, insert the combined unit into Tent E.

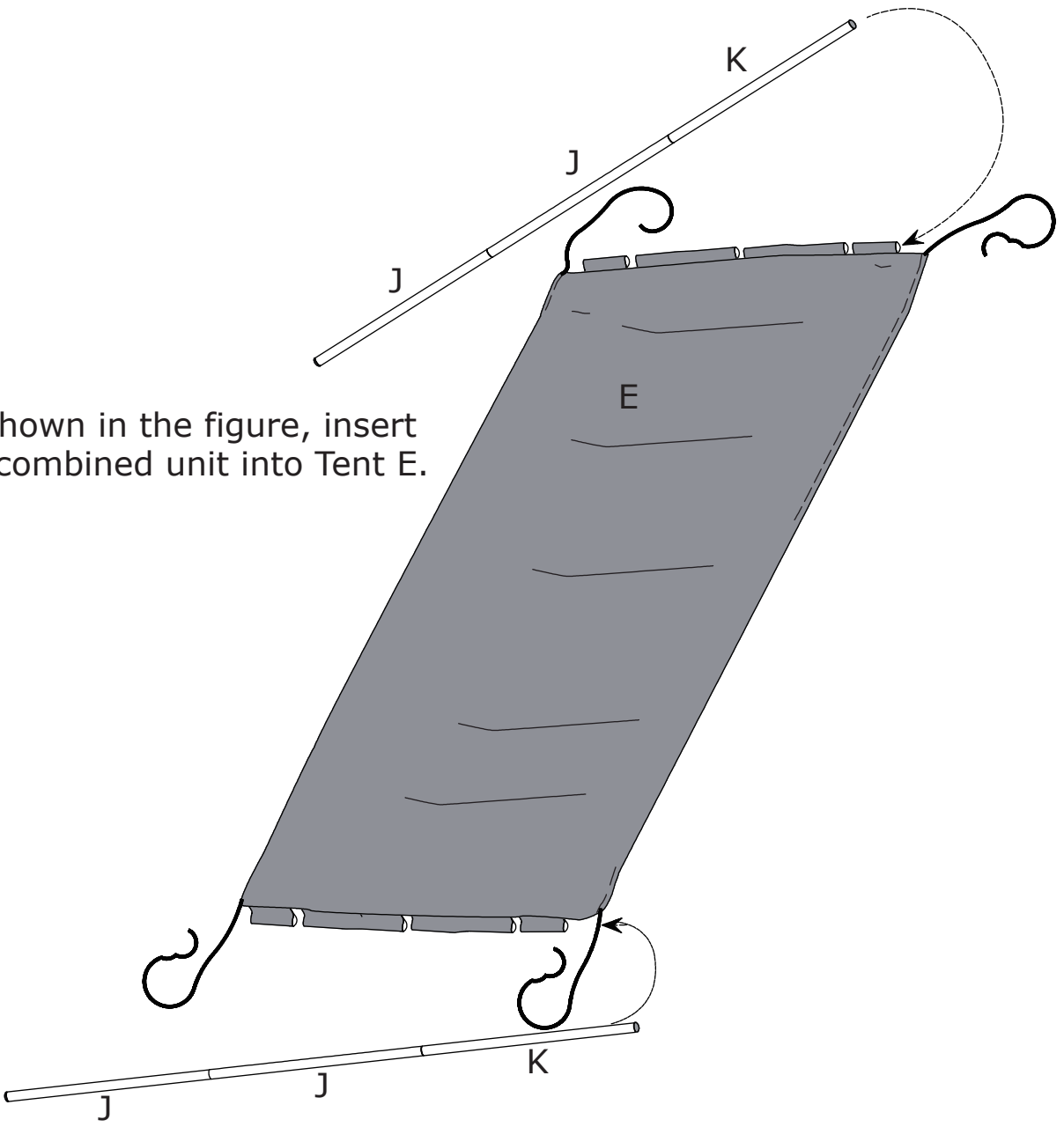

6

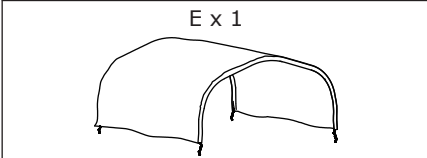

As shown in the figure, fix Tent E in the combined unit.

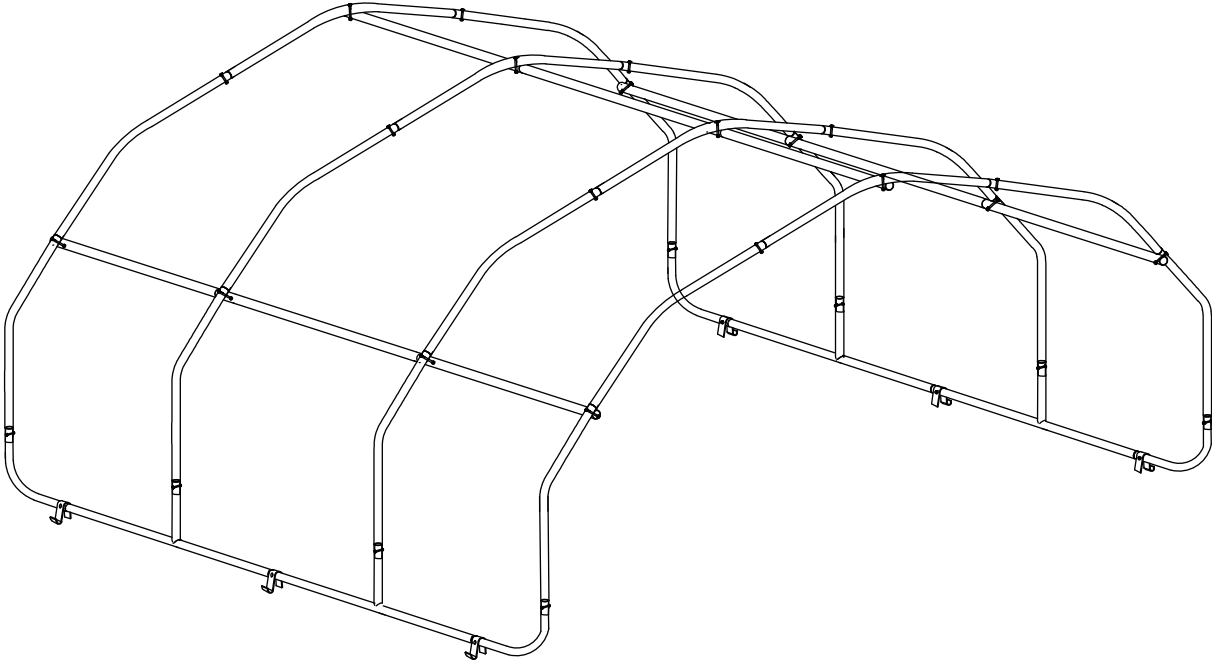
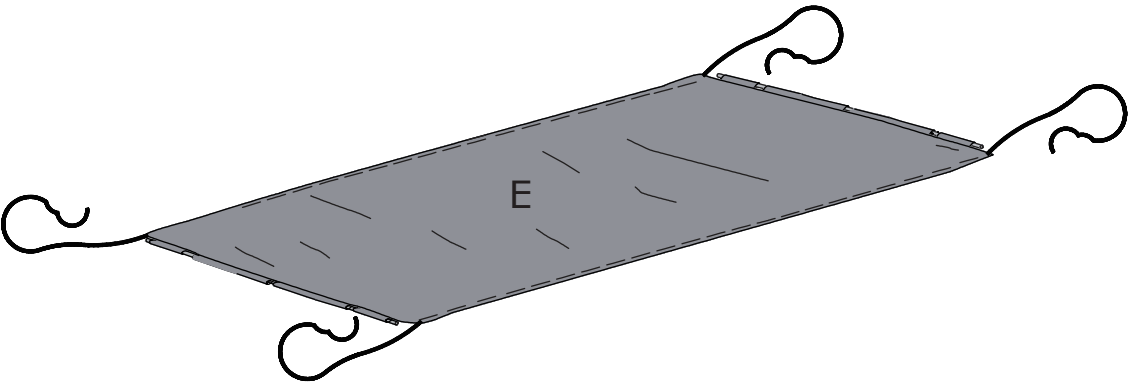

7

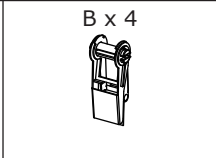
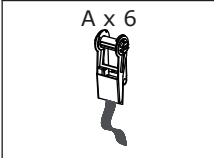

i

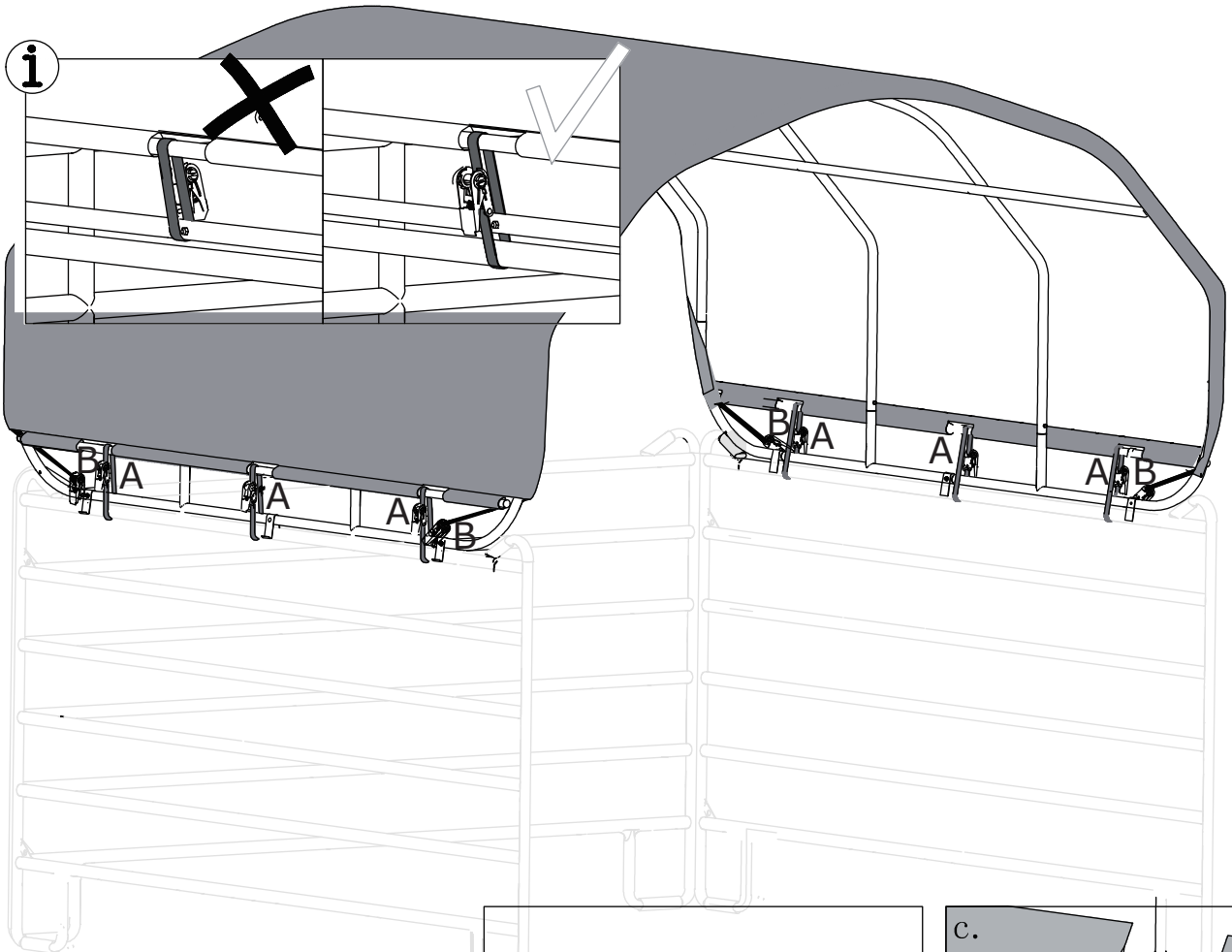

Face the 6 cover ratchets outward as shown. Failure to do so may result in injury to animals.

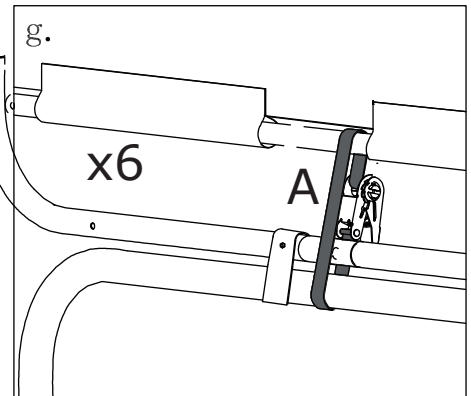
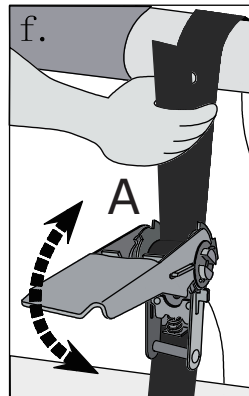
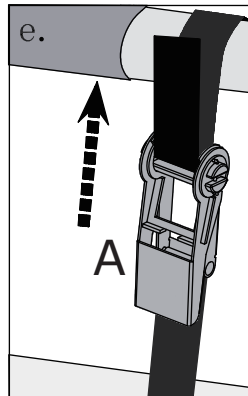
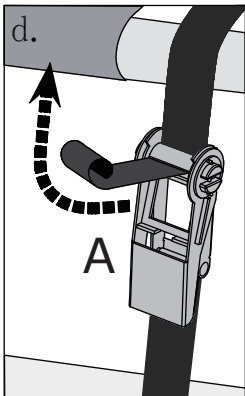
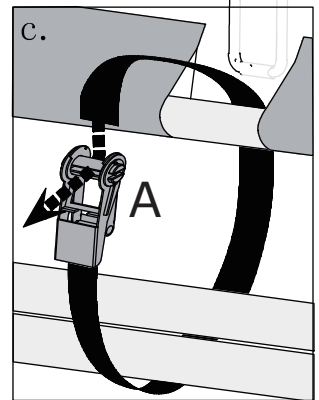
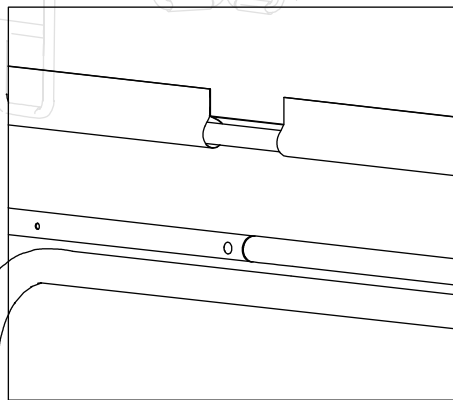

8

B x 4

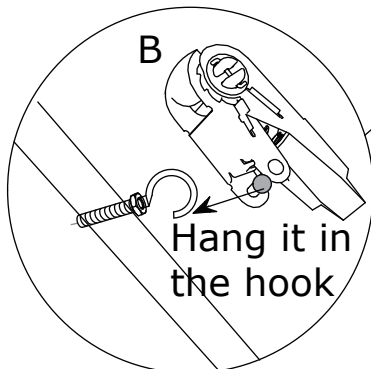
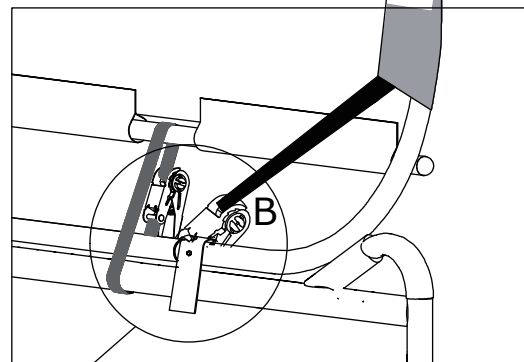
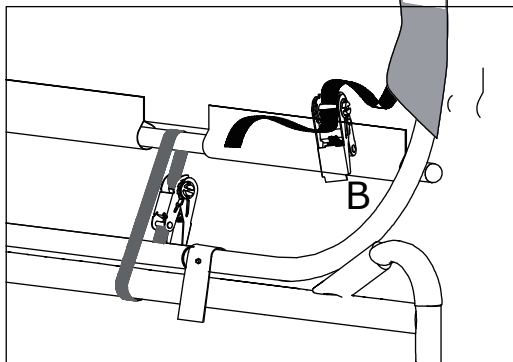
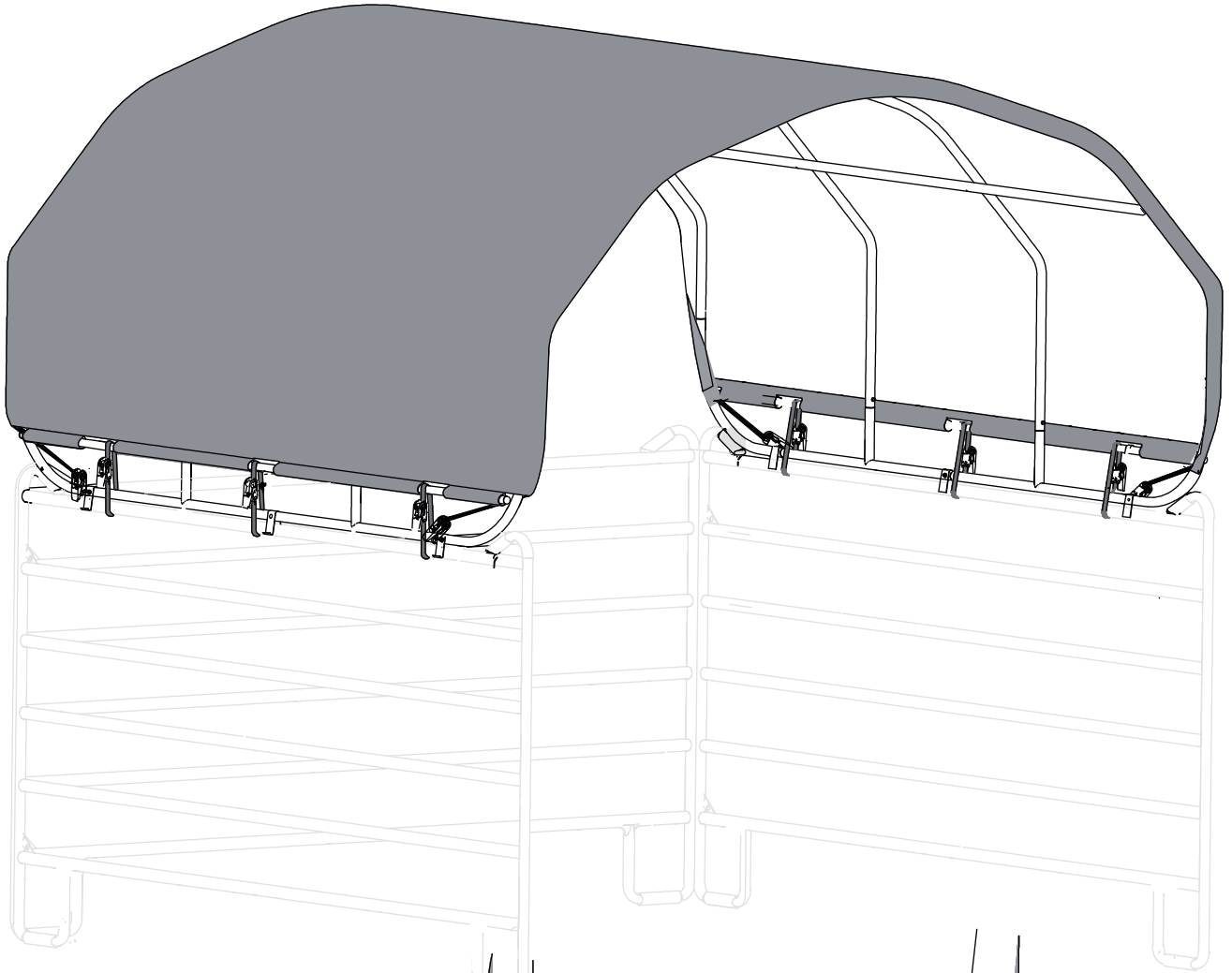

Face the 6 cover ratchets outward as shown. Failure to do so may result in injury to animals

# WARRANTY

## WARRANTY CLAIMS

- There is a 30-day warranty for broken furniture or any other problems that do not work properly. The warranty will start from the date of purchase which must be verified by proof of purchase.
- Before making a claim, we may be able to answer your query, simply call us. Please leave your purchase order number, along with some details of the problem, if you want a replacement part. We will arrange within 48 hours. If there is out of stock, we will reply with a shipping date.
- The product must be used in accordance with the instructions provided. For health reasons.
- For other reasons, if the furniture needs to be returned, it must be cleaned and dried and operated within 30 days of receipt.

## Type of Warranty Claim

- Failure to follow the furniture instructions will invalidate the warranty. Attention please.
- Does not include damage during installation, but includes damage during transportation.

## Scope of responsibility

- Shall not bear any responsibility for misuse or user damage and / or loss of parts during the installation of furniture.
- After using, the damage and scratches of the furniture are not covered by the warranty.

## The Warranty Relates to All Bought in The Us and Covers The Following Areas

- Sheet parts: 1 month from the date of purchase.
- Electrical parts: 1 month from the date of purchase.

# RETURNS

## CHANGED YOUR MIND AND NEED TO RETURN YOU ITEM?

### PLEASE FOLLOW THE BELOW INSTRUCTIONS:

- If you have purchased and have simply changed your mind, follow the retailer's instructions for returns.

### DEFECTIVE ITEMS

- If your item is defective in any way, i.e. it doesn't work but you can't identify why, in the first instance, please call us.

### DAMAGED ITEMS

- If you receive an order with obvious shipping damage from the retailer, then we suggest the delivery is refused. If the delivery has been accepted and then shipping damage is found, please follow the specific instructions advised by the retailer.  
In all circumstances please save all packaging material and paperwork for the order. Please be aware that if you dispose of packaging material or attempt to return the merchandise without contacting the fulfiller, you jeopardise your chances of making a claim, and you may not receive a credit for the return.

### AFTER-SALES CONTACT



[adelahu@fufugaga.com](mailto:adelahu@fufugaga.com)



208-820-0068