

**MODEL:IG10600047C-1010N-MP**

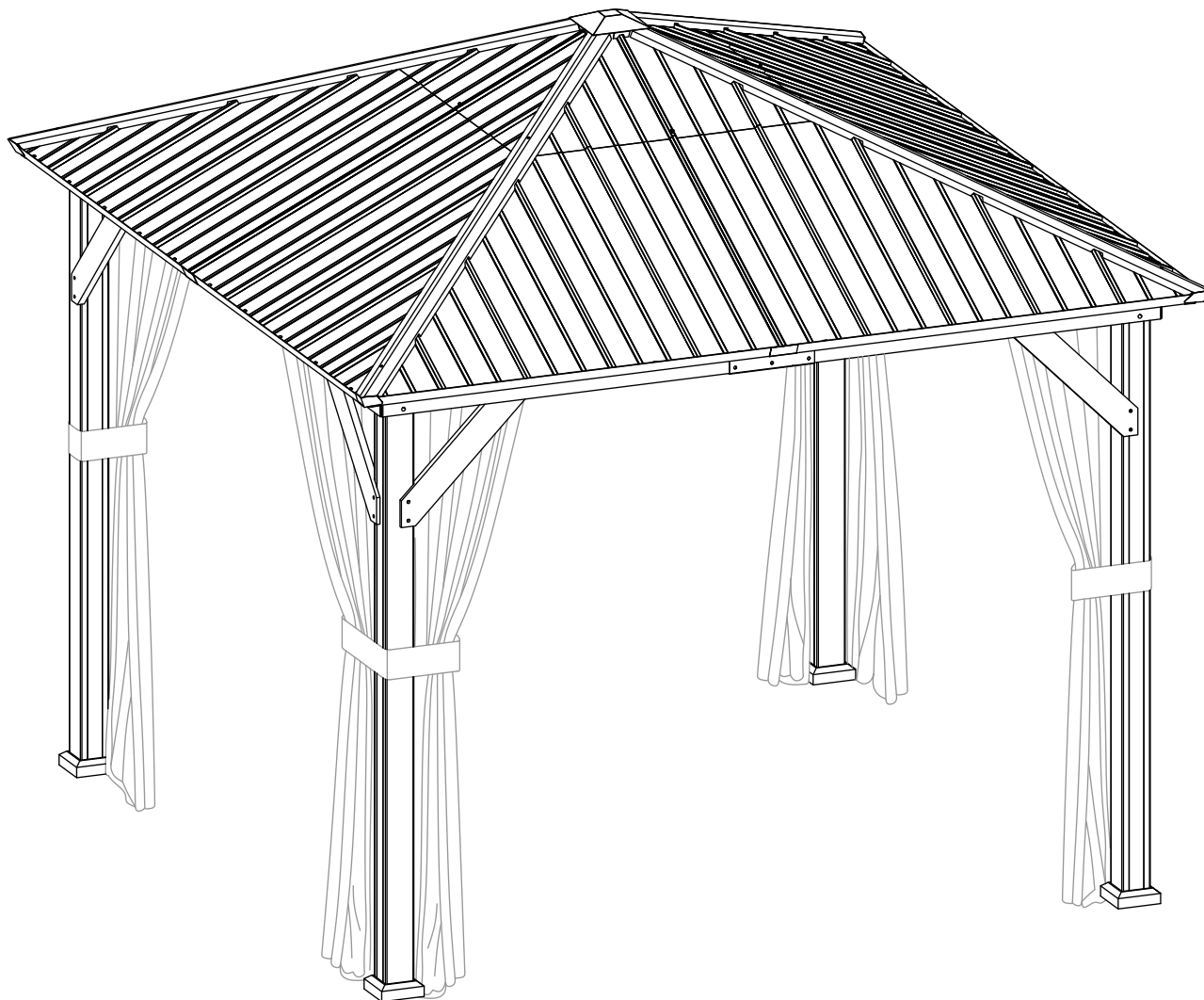

OWNER'S MANUAL

## Tranquil Grove 10' x 10' Cedar Framed Hardtop Pavilion

### TABLE OF CONTENTS

ASSEMBLY GUIDE.....	02
USING YOUR PRODUCT.....	04

November 18, 2025

### QUESTIONS?



E-mail: [support@modernshade.org](mailto:support@modernshade.org)













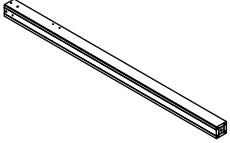
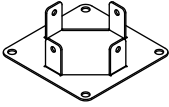
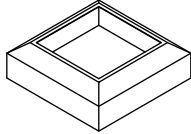
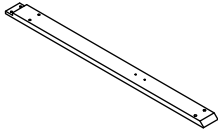
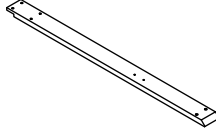
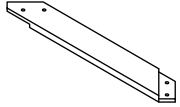
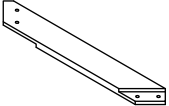

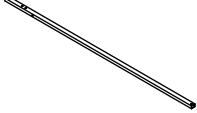
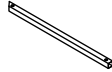
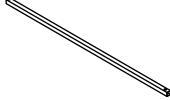
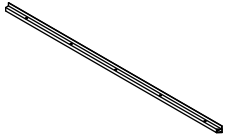
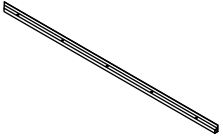
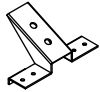
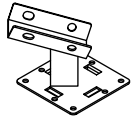
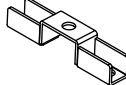
Toll Free Number: 1-888-666-3070

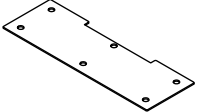
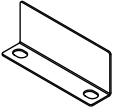
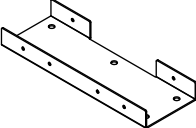
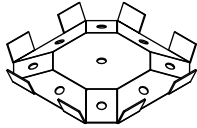

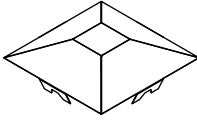
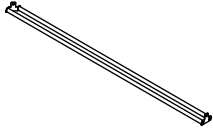
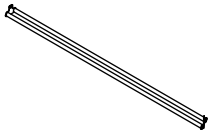

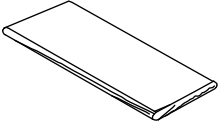
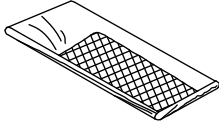
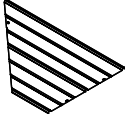
Mon-Fri: 9:00 AM - 5:00 PM PST.

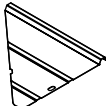
# ASSEMBLY GUIDE

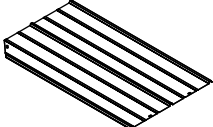
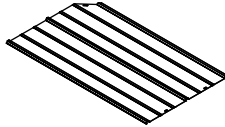
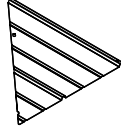
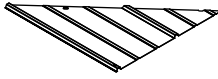
## PARTS LIST

<b>A3</b> Post 3 (4 pieces) 	<b>B2</b> Foot Base 2 (4 pieces) 	<b>C2</b> Foot Cover 2 (4 pieces) 	<b>D12</b> Cross Beam 12 (4 pieces) 	<b>D13</b> Cross Beam 13 (4 pieces) 	<b>E1</b> Support Bracket 1 (4 pieces) 
P0010000601	P0030000401	P0020000202	P0040019601	P0040019701	P0050000501
<b>E2</b> Support Bracket 2 (4 pieces) 	<b>F</b> Roof Rib (4 pieces) 	<b>G</b> Middle Cross Beam (4 pieces) 	<b>H1</b> Roof Support 1 (8 pieces) 	<b>H2</b> Roof Support 2 (8 pieces) 	<b>J5</b> Roof Border 5 (4 pieces) 
P0050000601	P0070000401	P0080000401	P0090002001	P0090002101	P0090001502
<b>J6</b> Roof Border 6 (4 pieces) 	<b>K1</b> Connector 1 (4 pieces) 	<b>K2</b> Connector 2 (4 pieces) 	<b>K3</b> Connector 3 (12 pieces) 	<b>K4</b> Connector 4 (12 pieces) 	<b>K6</b> Connector 6 (4 pieces) 
P0090001602	P0060001501	P0060001601	P0060000501	P0060000602	P0110006201
<b>K7</b> Connector 7 (4 pieces) 	<b>K23</b> Connector 23 (4 pieces) 	<b>K24</b> Connector 24 (1 piece) 	<b>L1</b> Roof Rib Cover 1 (4 pieces) 	<b>L13</b> Roof Cover 13 (1 piece) 	<b>M1</b> Mosquito Net Rod 1 (4 pieces) 
P0110000502	P0110006101	P0060001901	P0120000901	P0120000402	P0100000801
<b>M2</b> Mosquito Net Rod 2 (4 pieces) 	<b>N</b> Hook (1 piece) 	<b>X</b> Privacy Curtain (1 piece) 	<b>Y</b> Mosquito Netting (1 piece) 	<b>Z4</b> Roof Plate 4 (4 pieces) 	<b>Z5</b> Roof Plate 5 (4 pieces) 
P0100000901	P1000000100	P0210000901	P0220001301	P0130000499	P0130000599
<b>Z6</b> Roof Plate 6 (4 pieces) 	<b>Z7</b> Roof Plate 7 (4 pieces) 	<b>Z8</b> Roof Plate 8 (4 pieces) 	<b>Z9</b> Roof Plate 9 (4 pieces) 	<b>Z10</b> Roof Plate 10 (4 pieces) 	<b>Z11</b> Roof Plate 11 (4 pieces) 
P0130000699	P0130000799	P0130000699	P01300006799	P01300006899	P01300006999

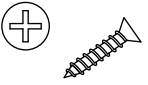
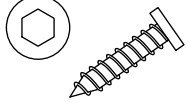
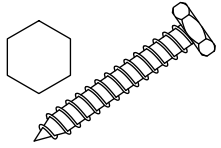
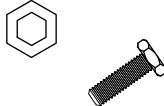
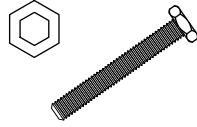
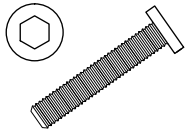
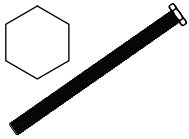
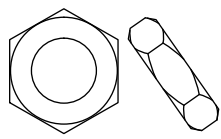
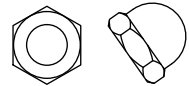
## HARDWARE

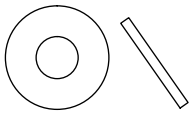
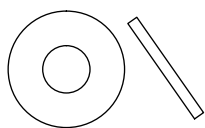
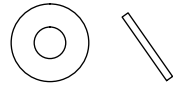
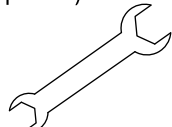
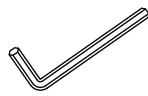
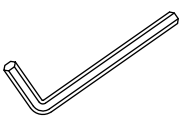
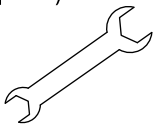
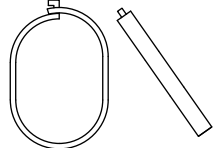
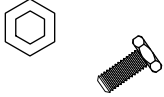
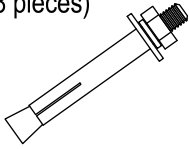
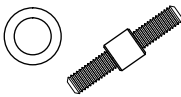
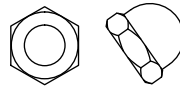
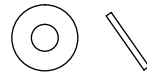
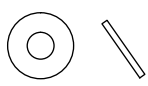
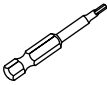
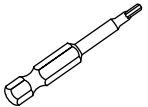
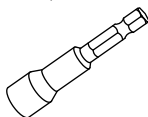
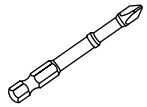
<b>AA</b> Self-tapping Bolt M5*25 (88+4 pieces) 	<b>BB</b> Self-tapping Bolt M8*35 (32+2 pieces) 	<b>CC</b> Self-tapping Bolt M10*65 (8+1 pieces) 	<b>DD</b> Bolt M6*20 (132+7 pieces) 	<b>EE</b> Bolt M6*45 (8+1 pieces) 	<b>FF</b> Bolt M8*45 (24+1 pieces) 
H0008008098	H0008008099	H0008008100	H0008008036	H0008008016	H0008008191
<b>GG</b> Bolt M10*150 (8+1 pieces) 	<b>HH</b> Anti-slip Screw Nut M10 (8+1 pieces) 	<b>JJ</b> M8 Ball nut (24+1 pieces) 	<b>KK</b> M6 Flat washer (180+9 pieces) 	<b>LL</b> M8 Flat washer (80+4 pieces) 	<b>MM</b> M10 Flat washer (24+2 pieces) 
H0008008165	H0008008126	H0008008192	H0008008057	H0008008058	H0008008141
<b>NN</b> M6 Sealant Washer (8+1 pieces) 	<b>PP</b> Double Open End Wrench M8/M10 (2 pieces) 	<b>RR</b> M6 Allen Key (2 pieces) 	<b>SS</b> M8 Allen Key (1 piece) 	<b>TT</b> Double Open End Wrench M5/M6 (1 piece) 	<b>UU</b> Rings (80+4 pieces) 
H0008008060	H0008008190	H0008008133	H0008008129	H0008008121	H0008008113
<b>VV</b> Bolt M6*15 (40+2 pieces) 	<b>XX</b> Concrete Anchor M6*60 (8 pieces) 	<b>YY</b> M5x39 Double head screw (4+1 pieces) 	<b>ZZ</b> M5 Ball nut (4+1 pieces) 	<b>ZY</b> M5 Flat washer (4+1 pieces) 	<b>ZX</b> M5 Sealant Washer (4+1 pieces) 
H0008008001	H0008008095	H0008008163	H0008008164	H0008008056	H0008008059
<b>ZU</b> M6 Hex drill bit (1 piece) 	<b>ZT</b> M8 Hex drill bit (1 piece) 	<b>ZS</b> M10 Hex socket drill bit (1 piece) 	<b>ZR</b> Phillips drill bit (1 piece) 		
H0008008209	H0008008210	H0008008208	H0008008215		

### IMPORTANT:

This instruction manual contains important information necessary for the proper assembly and safe use of the product.

Read and follow all warnings and instructions before assembling and using the product.

Follow all warnings and instructions when using the product.

Keep this manual for future reference.

Installer/Assembler: leave these instructions with the consumer.

### SAFETY ALERT KEY

#### DANGER

Indicates a hazardous situation that, if not avoided, will result in death or serious injury.

#### WARNING

Indicates a hazardous situation that, if not avoided, could result in death or serious injury.

#### CAUTION

Indicates a hazardous situation that, if not avoided, could result in minor or moderate injury.

#### NOTICE

Indicates information considered important, but not hazard-related (e.g. messages related to property damage).

# ASSEMBLY INSTRUCTIONS

•Please carefully unpack each of the components and hardware. check the components against the parts list and make sure there are no missing parts. lay pieces on cardboard or a soft mat to help protect the pieces from scratches.

## ⚠ CAUTION

Watch for sharp edges when handling the pieces, wear gloves to avoid injury.

- For ease of assembly, it is recommended to have 3 or more people and allow enough time to completely finish the assembly. assembly can take 6-8 hours. a step-ladder is required for assembly (not included).
- Follow step by step instructions, and follow all safety warnings provided with your tools.
- DO NOT tighten screws until all the screws and washers are properly installed. Tighten screws securely, do not over tighten.
- Gazebo should not be used in inclement weather and high winds.

**STEP 01** Slide foot cover **C2** and foot base **B2** onto post **A3**. Use four (4) **[AA]** bolts to attach foot base **B2** to post **A3**. Repeat with the other three (3) posts **A3**.

**[AA]** x 16

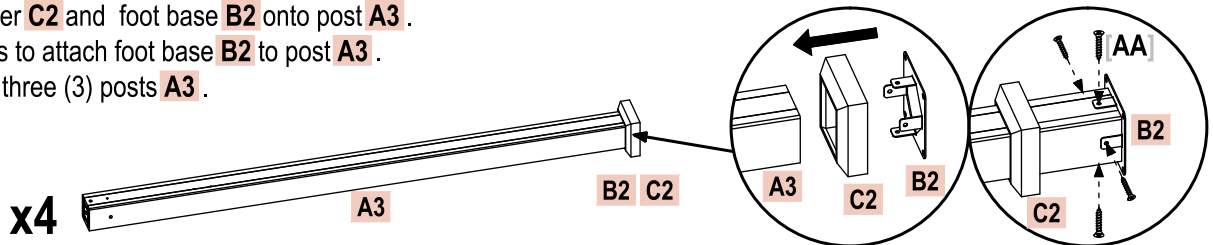

**STEP 02** Attach cross beam **D12** and **D13** together using connector **K23** and **K6**. Secure with six (6) **[FF]** bolts, twelve (12) **[LL]** flat washers and six (6) **[JJ]** ball nuts on the sides. Use six (6) **[AA]** bolts secure both the top and bottom of the connection. Repeat with the other three (3) cross beam assemblies.

**[AA]** x 24

**[FF]** x 24

**[JJ]** x 24

**[LL]** x 48

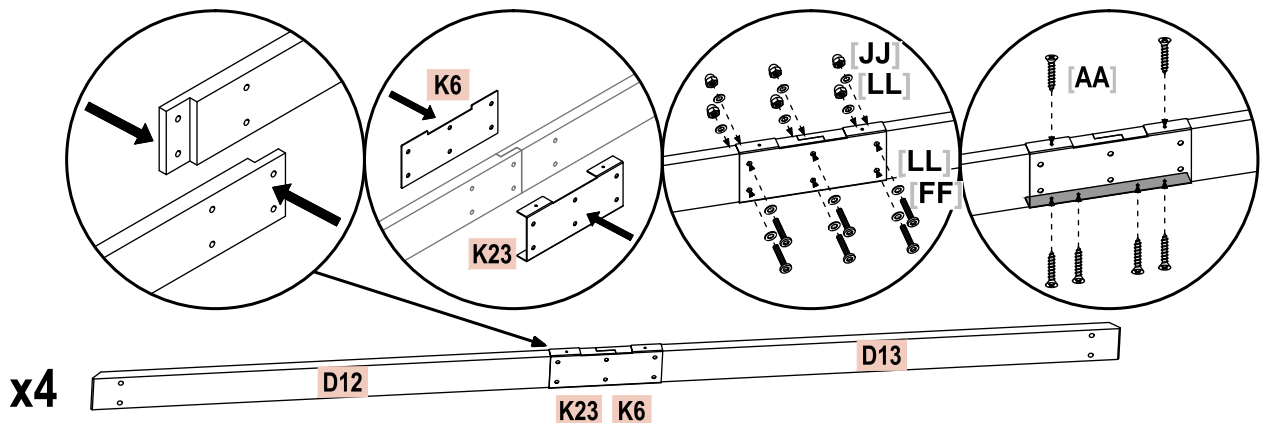

**STEP 03** Use one (1) **[CC]** bolt and one (1) **[MM]** flat washer on the top hole, one (1) **[GG]** bolt, two (2) **[MM]** flat washers and one (1) **[HH]** screw nut on the bottom hole to attach the left end of cross beam assembly **D12**, **D13** to post **A3**.

Use one (1) **[GG]** bolt, two (2) **[MM]** flat washers and one (1) **[HH]** screw nut on the top hole, one (1) **[CC]** bolt and one (1) **[MM]** flat washer on the bottom hole to attach the right end of cross beam assembly **D12**, **D13** to post **A3**.

Repeat with the other assembly set.

**[CC]** x 4

**[GG]** x 4

**[HH]** x 4

**[MM]** x 12

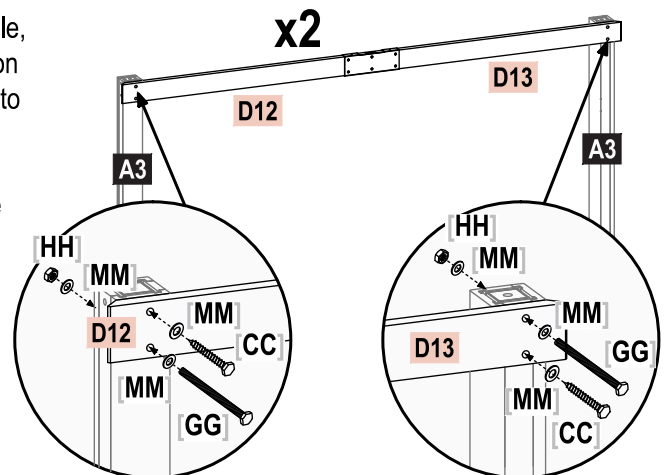

**STEP 04** Use one (1) [CC] bolt and one (1) [MM] flat washer on the top hole, one (1) [GG] bolt, two (2) [MM] flat washers and one (1) [HH] screw nut on the bottom hole to attach the left end of cross beam assembly **D12**, **D13** to post **A3**. Use one (1) [GG] bolt, two (2) [MM] flat washers and one (1) [HH] screw nut on the top hole, one (1) [CC] bolt and one (1) [MM] flat washer on the bottom hole to attach the right end of cross beam assembly **D12**, **D13** to post **A3**. Repeat with the other assembly set.

- [CC] x 4
- [GG] x 4
- [HH] x 4
- [MM] x 12

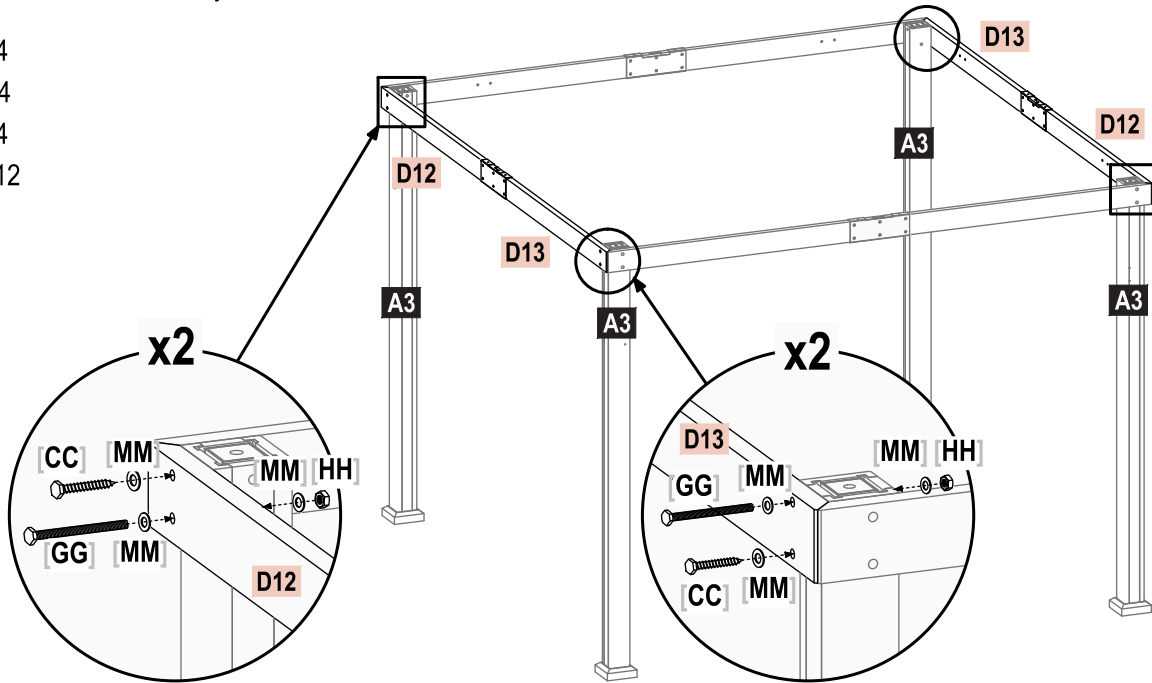

**STEP 05 CRITICAL: SQUARE UNIT BEFORE PROCEEDING TO NEXT STEPS.**  
**ONCE SQUARE, TIGHTEN ALL HARDWARE.**

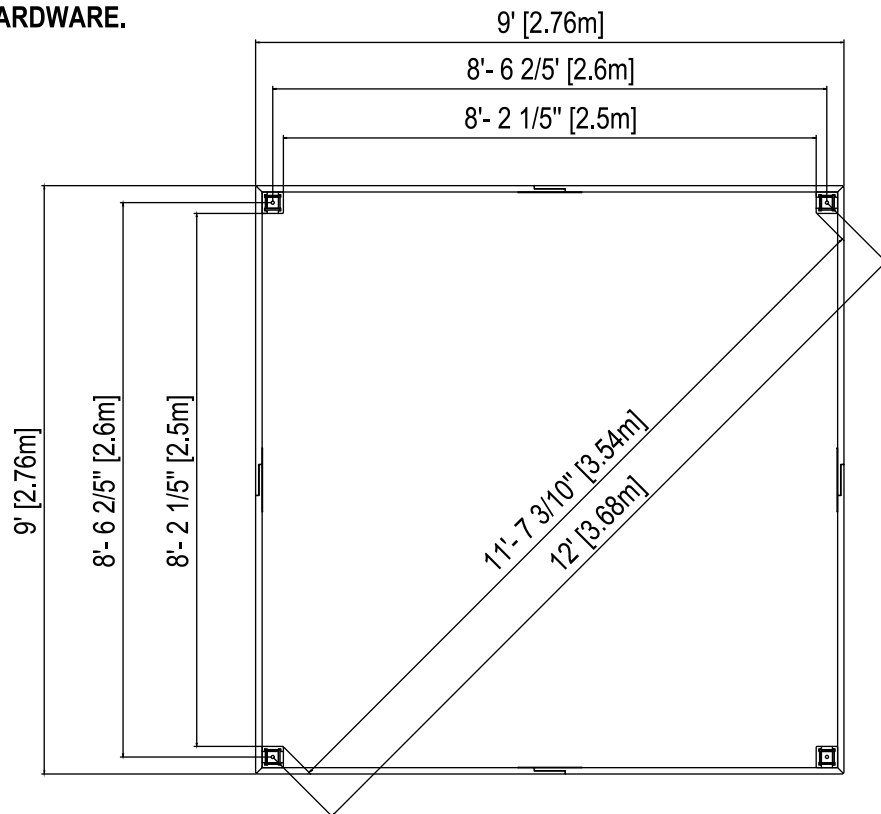

**STEP 06** Use four (4) [BB] bolts and four (4) [LL] flat washers to attach one (1) support bracket **E1** to cross beam and post on left corner of each side. Repeat with the other three (3) support brackets **E1**.

Use four (4) [BB] bolts and four (4) [LL] flat washers to attach one (1) support bracket **E2** to cross beam and post on right corner of each side. Repeat with the other three (3) support brackets **E2**.

[BB] x 32

[LL] x 32

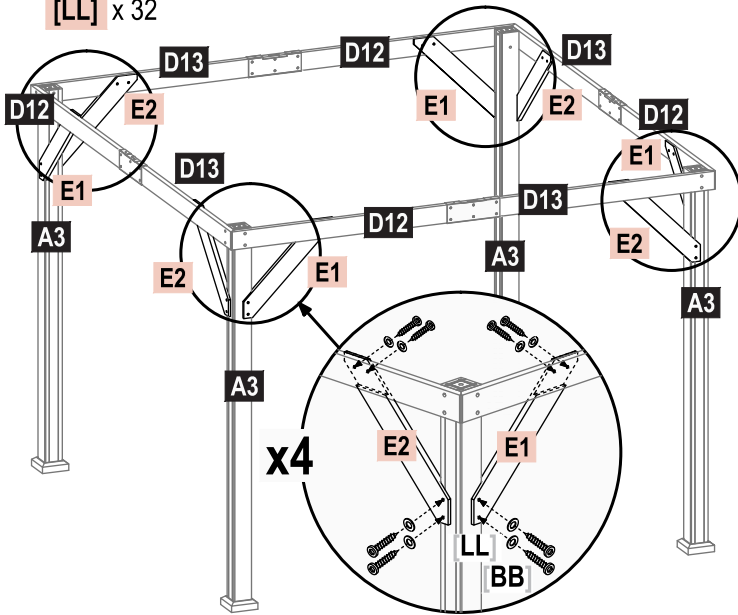

**STEP 07** Use eight (8) [AA] bolts to attach one (1) connector **K2** to post **A3**. Repeat with the other three (3) connector **K2**.

[AA] x 32

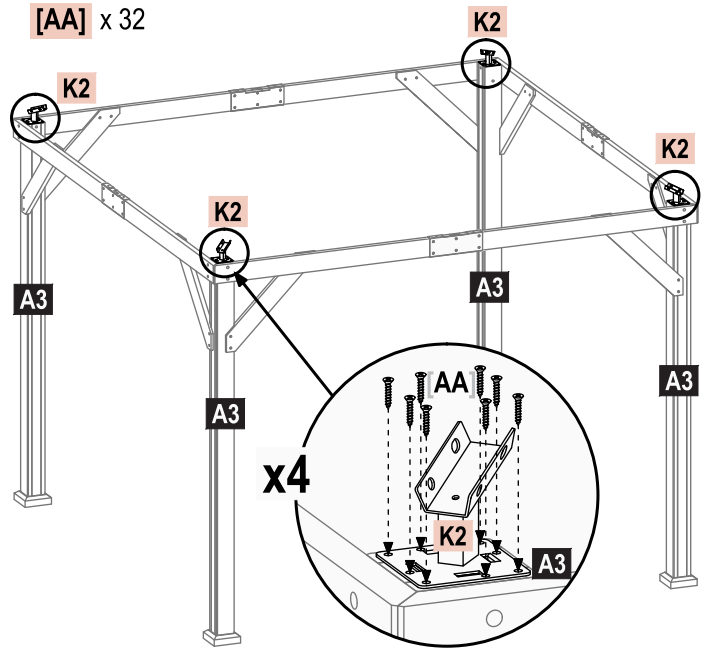

**STEP 08** Use two (2) [DD] bolts and two (2) [KK] flat washers to attach roof rib **F** to connector **K2**. Repeat with the other three (3) roof rib **F**.

[DD] x 8

[KK] x 8

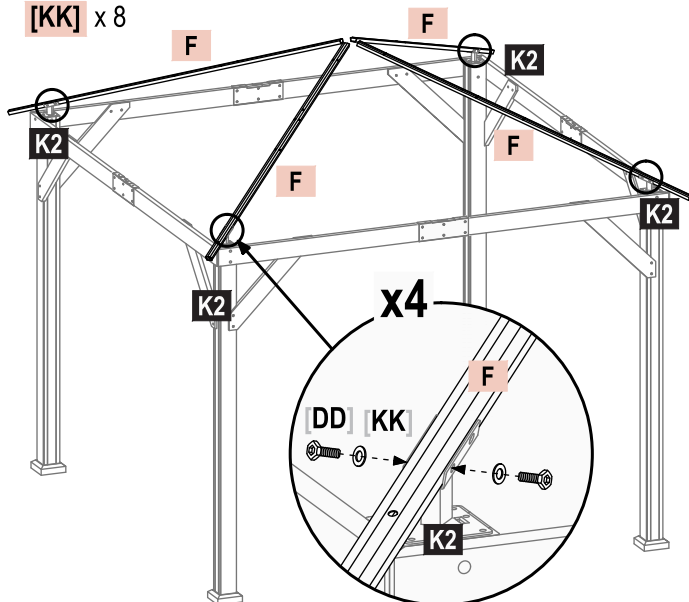

**STEP 09** Use one (1) [DD] bolt and one (1) [KK] flat washer to attach one (1) connector **K4** to roof rib **F**. Repeat with the other two (2) connector **K4** on one **F**. Repeat with the other three (3) roof rib **F**.

[DD] x 12

[KK] x 12

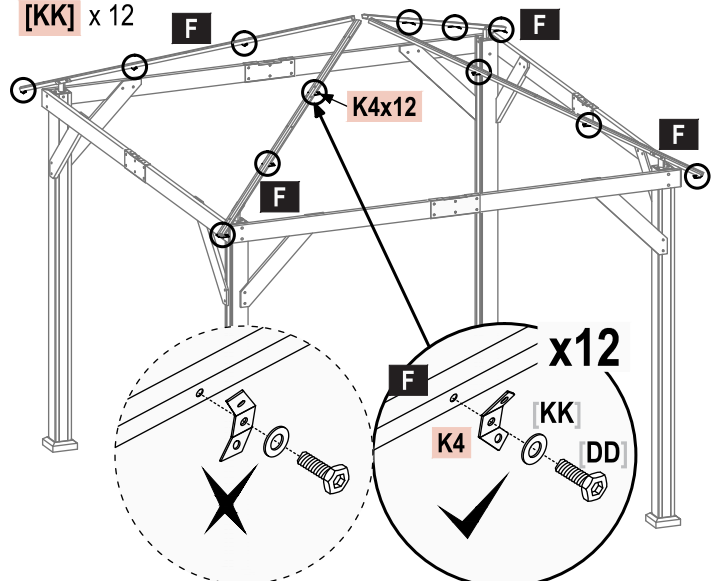

Make sure the connectors face upward as shown.

**STEP 10** Use four (4) [DD] bolts and four (4) [KK] flat washers to attach connector **K24** to roof ribs **F**.

[DD] x 4

[KK] x 4

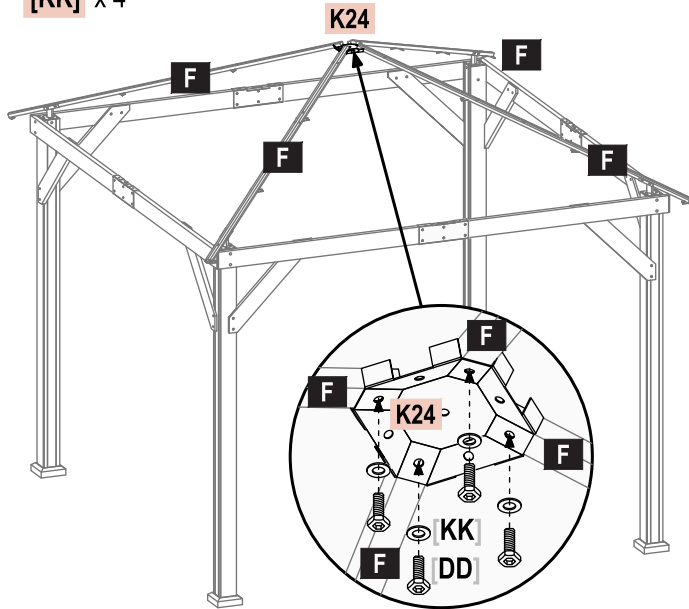

**STEP 11** Use one (1) [DD] bolt and one (1) [KK] flat washer to attach one (1) connector **K3** to middle cross beam **G**. Repeat with the other connector **K3**. Use one (1) [YY] screw to attach one connector **K3** to middle cross beam **G**. Use two (2) [DD] bolts and two (2) [KK] flat washers to attach one (1) connector **K1** to the end of middle cross beam **G**. Repeat to make another three (3) assemblies.

[DD] x 16

[KK] x 16

[YY] x 4

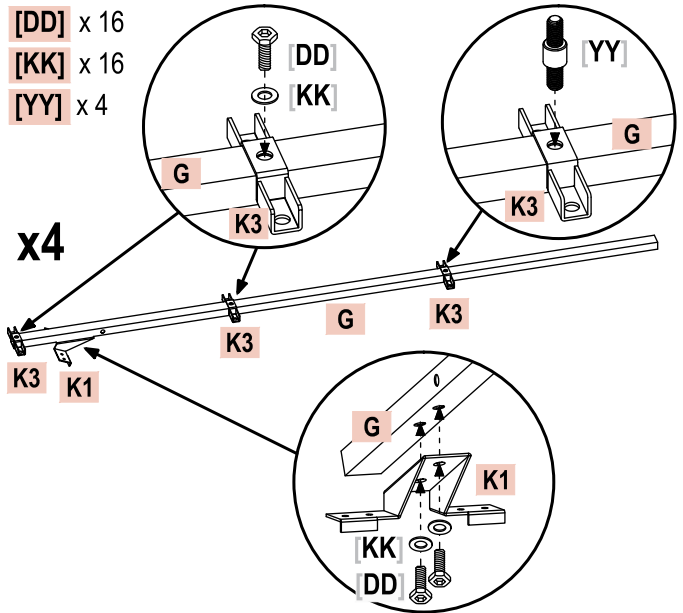

**STEP 12** Use one (1) [DD] bolt and one (1) [KK] flat washer to attach upper end of middle cross beam **G** to connector **K24**. Use four (4) [AA] bolts to attach connector **K1** on the other end of **G** to cross beams.

Repeat with the other three (3) middle cross beams **G**.

[AA] x 16

[DD] x 4

[KK] x 4

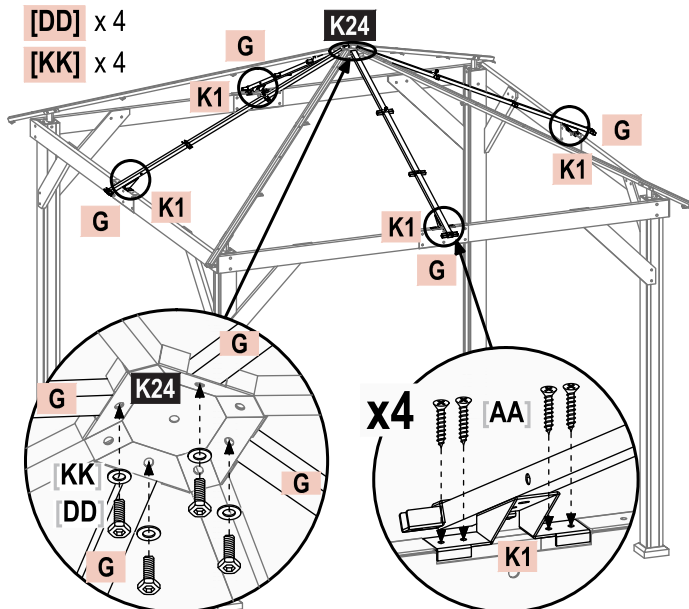

**STEP 13** Use one (1) [VV] bolt, one (1) [DD] bolt and two (2) [KK] flat washers to attach one (1) mosquito net rod **M1** to roof rib **F** and middle cross beam **G**. Repeat with the other three (3) **M1** and four (4) **M2**.

[DD] x 8

[VV] x 8

[KK] x 16

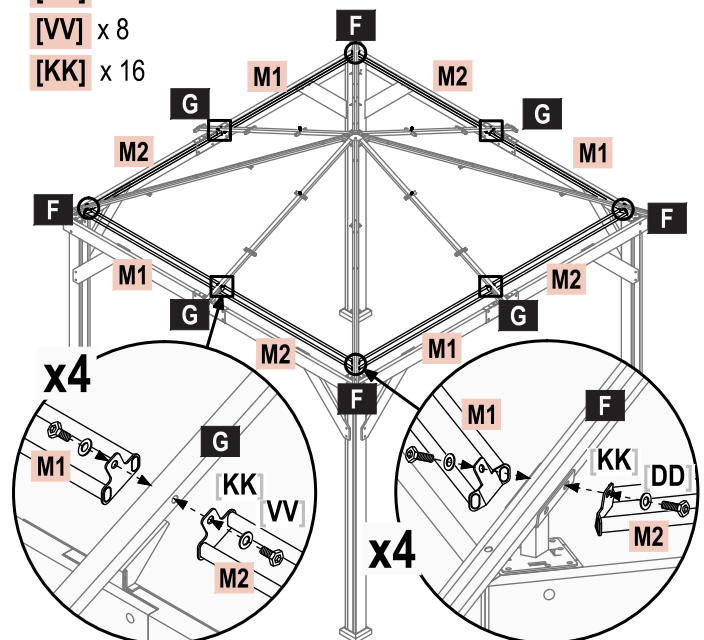

**STEP 14** Slide roof support **H1** to connector **K3**. Use two (2) **[VV]** bolts and two (2) **[KK]** flat washers to attach one (1) roof support **H1** to connector **K3** and **K4**. Repeat with the other seven (7) **H1**.

**[VV]** x 16  
**[KK]** x 16

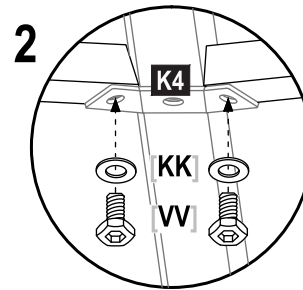
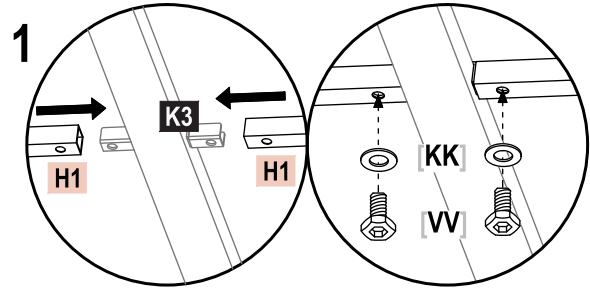
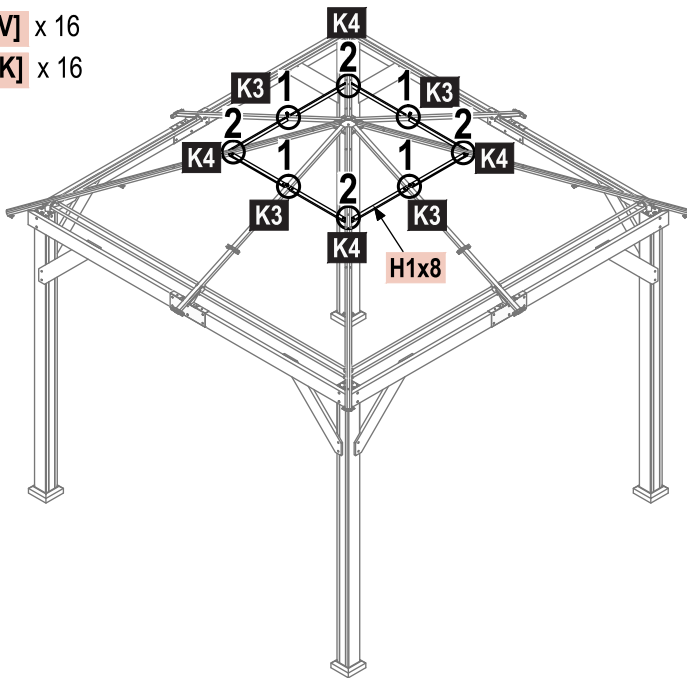

**STEP 15** Slide roof support **H2** to connector **K3**. Use two (2) **[VV]** bolts and two (2) **[KK]** flat washers to attach one (1) roof support **H2** to connector **K3** and **K4**. Repeat with the other seven (7) **H2**.

**[VV]** x 16  
**[KK]** x 16

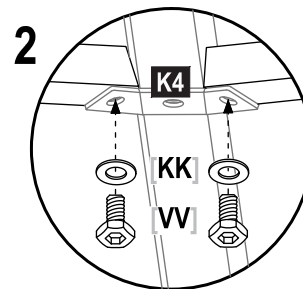
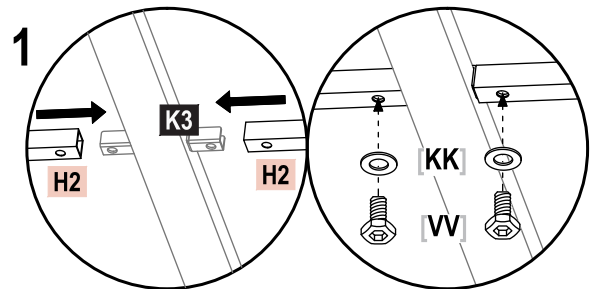
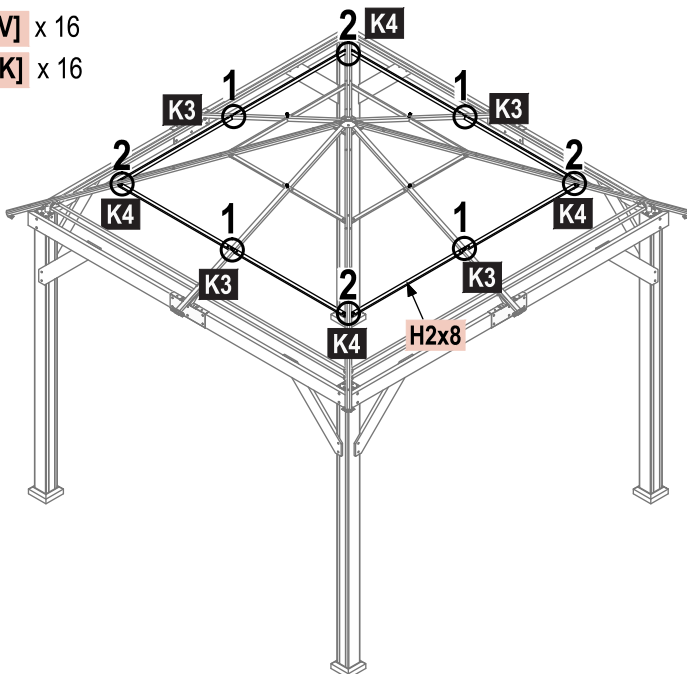

**STEP 16** Slide roof border **J5** to connector **K3**. Use one (1) **[DD]** bolt and one (1) **[KK]** flat washer to attach one (1) roof border **J5** to connector **K4**. Repeat with the other three (3) **J5** and four (4) **J6**.

**[DD]** x 8  
**[KK]** x 8

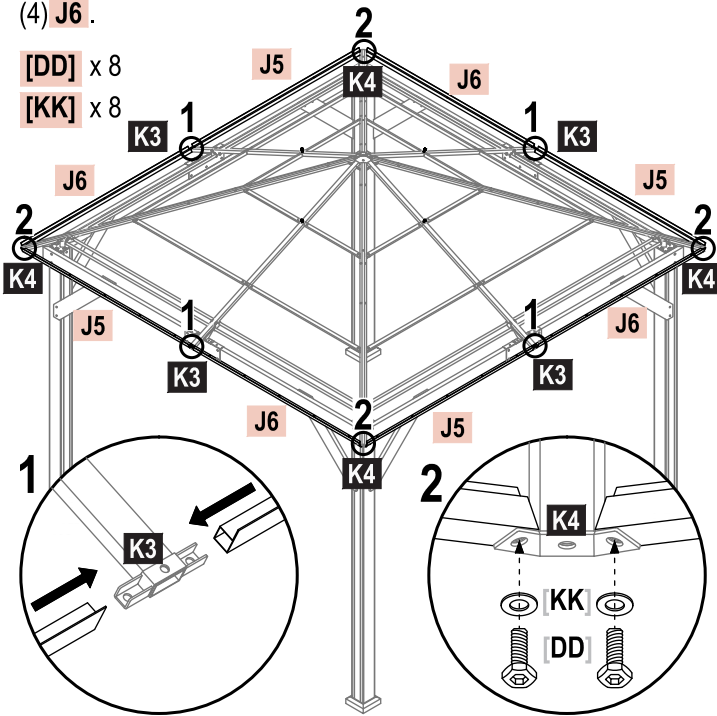

**STEP 17** Use two (2) **[DD]** bolts and two (2) **[KK]** flat washers to attach one (1) connector **K7** to roof borders. Repeat with the other three (3) connector **K7**.

**[DD]** x 8  
**[KK]** x 8

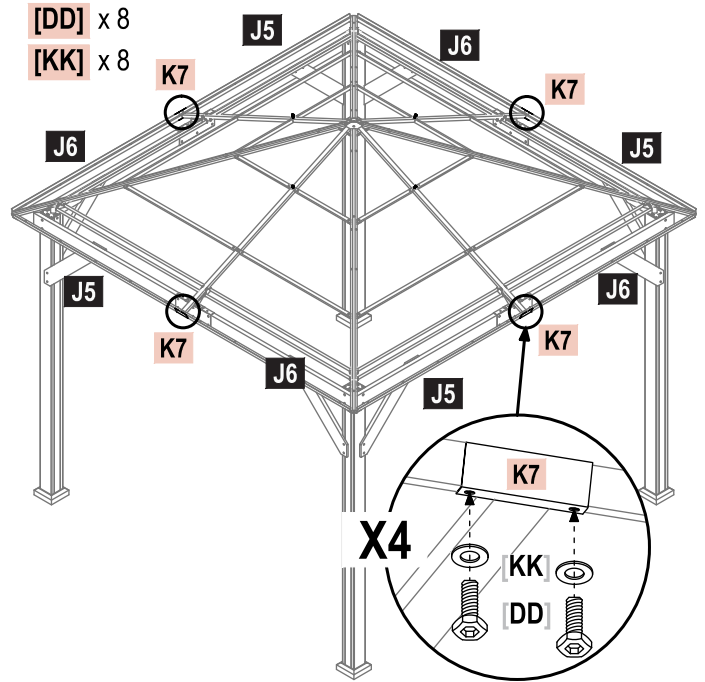

**STEP 18** DO NOT tighten the bolts completely until all the bolts and washers are properly installed.

Overlap the edges of the adjacent roof plates together. Use one (1) **[DD]** bolt and one (1) **[KK]** flat washer to attach each hole of roof plates **Z8** and **Z9** to the frame.

**[DD]** x 24  
**[KK]** x 24

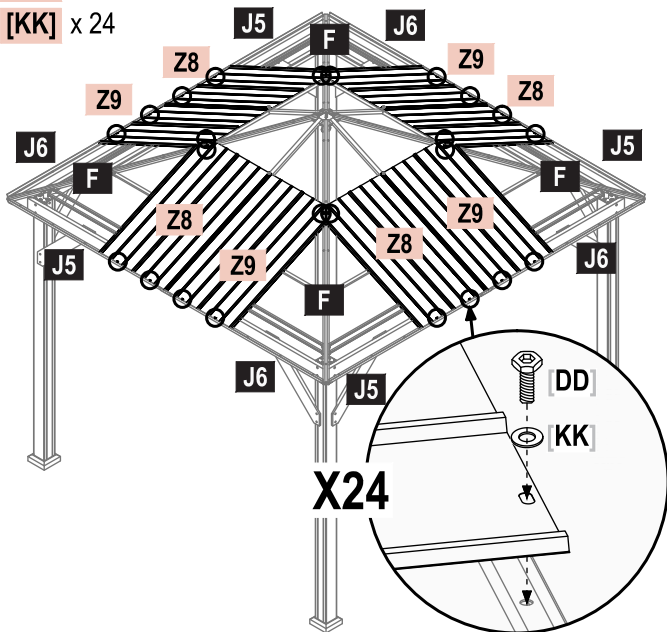

**STEP 19** DO NOT tighten the bolts completely until all the bolts and washers are properly installed.

Overlap the edges of the adjacent roof plates together. Use one (1) **[DD]** bolt and one (1) **[KK]** flat washer to attach each top hole of roof plates **Z10** and **Z11** to the frame. Use one (1) **[ZZ]** ball nut, one (1) **[ZY]** flat washer and one (1) **[ZX]** flat washer to attach each bottom hole of roof plates **Z10** and **Z11** to the **[YY]** screw.

**[DD]** x 8  
**[KK]** x 8  
**[ZZ]** x 4  
**[ZY]** x 4  
**[ZX]** x 4

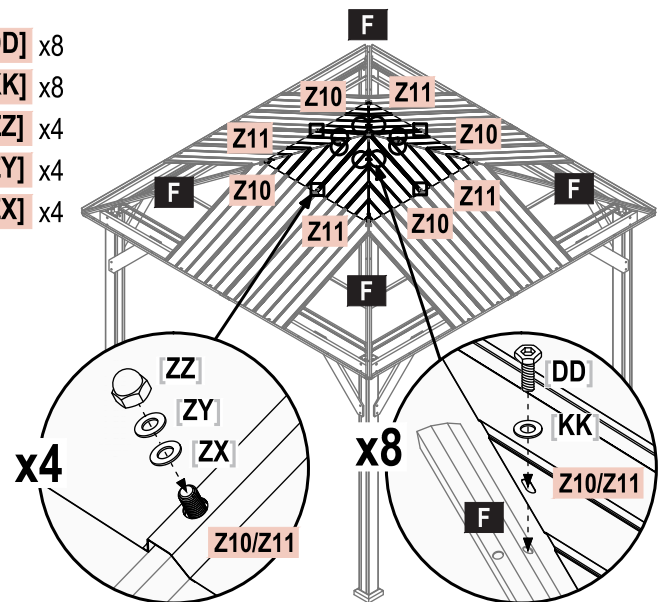

**STEP 20** Attach hook **N** to roof cover **L13** through connector **K24** .

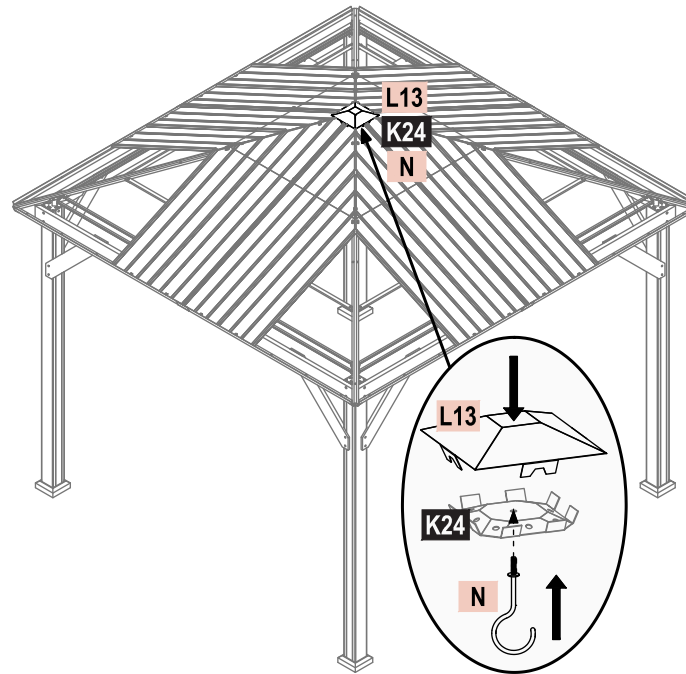

**STEP 21** DO NOT tighten the bolts completely until all the bolts and washers are properly installed.

Overlap the edges of the adjacent roof plates together.

Use one (1) **[DD]** bolt and one (1) **[KK]** flat washer to attach each hole of roof plates **Z4** , **Z5** , **Z6** , **Z7** to the frame.

**[DD]** x 32

**[KK]** x 32

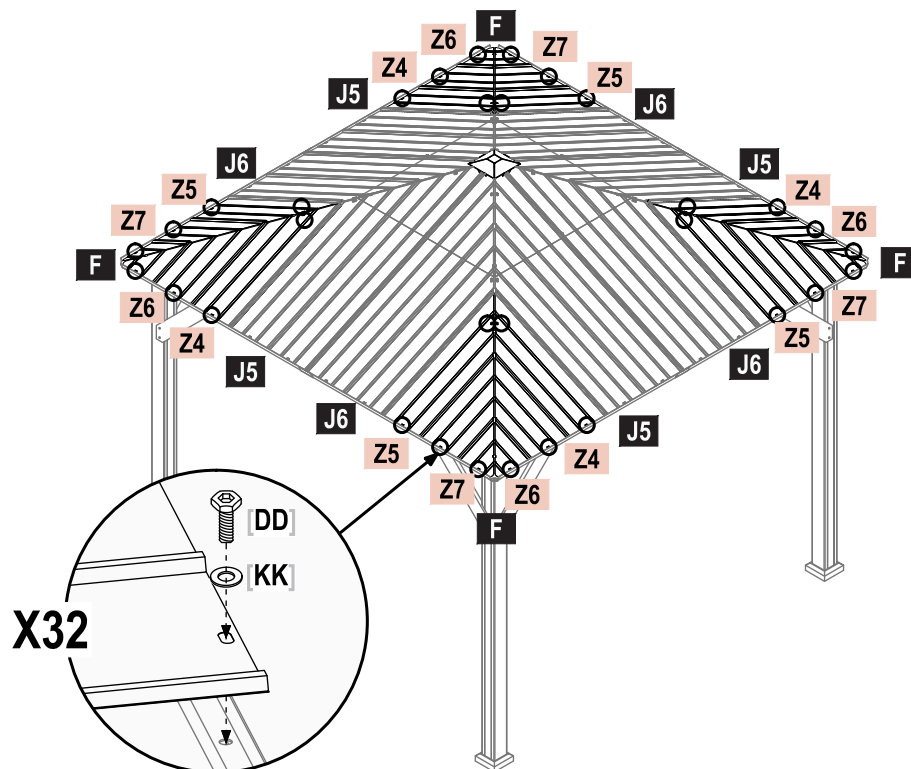

**STEP 22** Use two (2) [EE], two (2) [KK] flat washers and two (2) [NN] flat washers to attach one (1) roof rib cover L1 to the roof. Repeat with the other three (3) roof rib cover L1.

- [EE] x 8
- [KK] x 8
- [NN] x 8

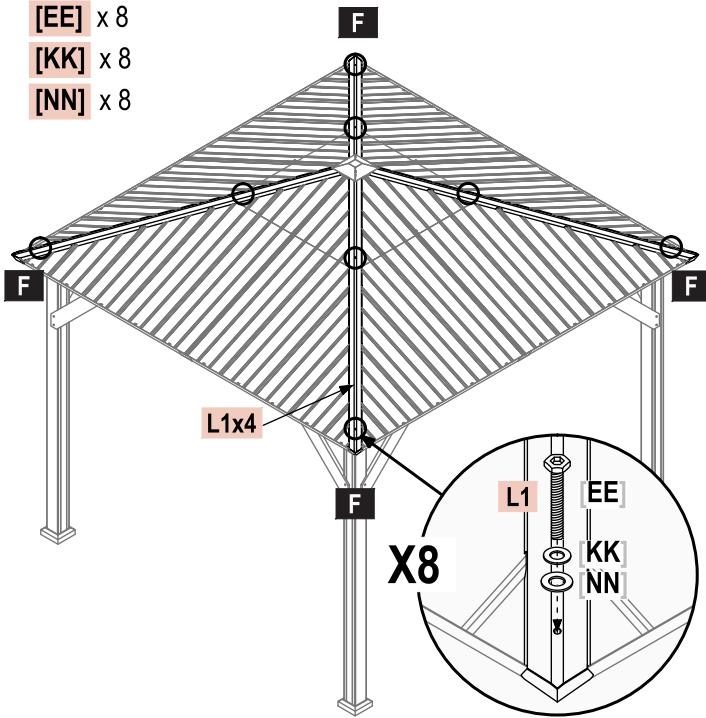

**STEP 23** Use forty (40) rings to attach privacy curtain X to the gazebo as needed.

- [UU] x40

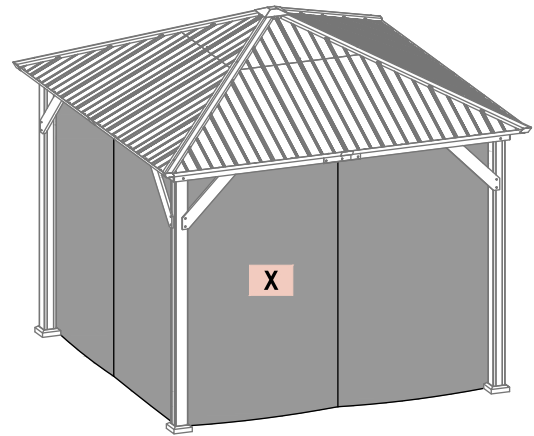
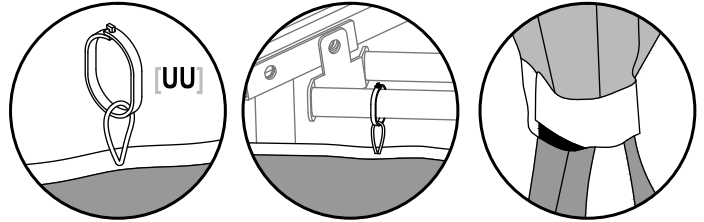

**STEP 24** Use forty (40) rings to attach mosquito netting Y to the gazebo as needed.

- [UU] x40

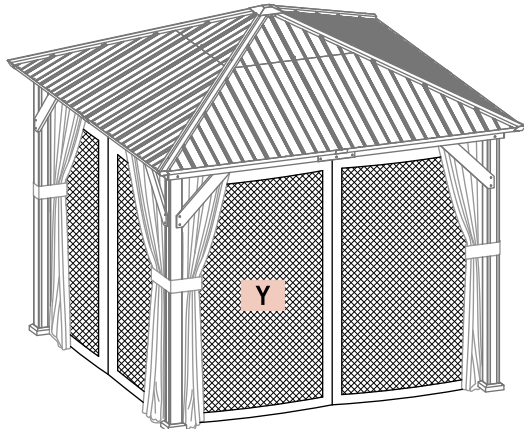
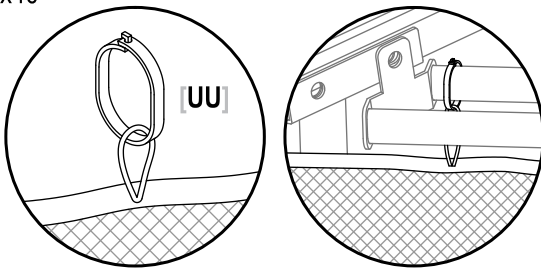

**STEP 25** Use two (2) [XX] expansion bolts to anchor each post foot base B2. please make sure the expansion bolts are fully anchored. We recommend using a 3/8 inch drill bit when installing the included expansion bolts.

- [XX] x 8

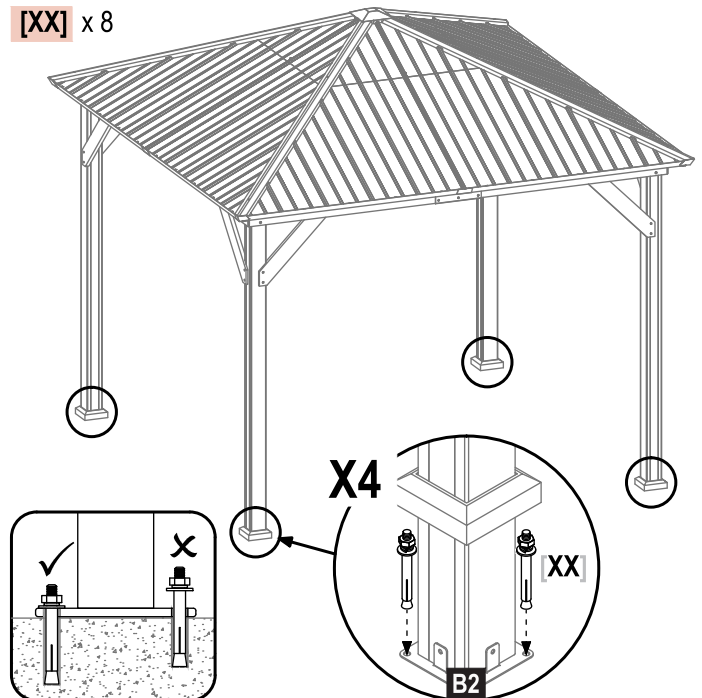

Outdoor Structure anchoring guide for anchoring gazebo to wood or concrete: If step 25, on page 11 in the assembly instructions is not properly completed, this will void the warranty.

**WARNING!** If your gazebo is not properly anchored, damage could occur. It is highly recommended for maximum safety that you mount and secure to wood or concrete footers. This is far better and safer than using ground stakes. The following are some examples of how to mount the structure to wood or concrete surfaces. Refer to local building codes or consider consulting a licensed contractor for assistance in the anchoring of this product.

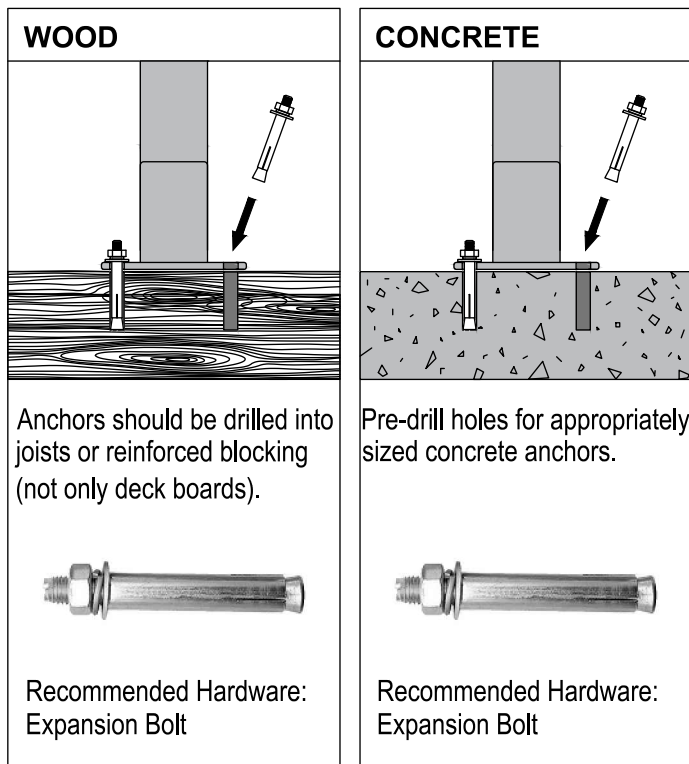

If digging for foundation, please double check for possibility of any underground utilities such as gas, telephone, cable or sprinkler lines. Refer to your local building and city codes, ordinances, neighborhood covenants, or height restrictions regarding this type of structure for guidance on acceptable installation requirements.

**CAUTION**

DO NOT climb or walk on roof for any reason.

- Our components are intended for privacy, decorative and ornamental use only.
- Product is NOT INTENDED for the following:
  - A safety barrier to prevent unsupervised access to pools, hot tubs, spas or ponds.
  - As load bearing support for a building, structure, heavy objects or swings.
  - Used in structures that trap wind, rain or snow that would create extra load on the product.
  - Accumulated snow must be removed from roof.
  - DO NOT climb or walk on roof for any reason.

### LIMITED WARRANTY

We warrants this product against defects in materials and workmanship for a period of one (1) year from the original date of purchase. To the extent any such defects occur, our products will send the appropriate replacement part(s) at no charge.

This warranty does not cover:

- Inspection costs or labor for replacement of any defective parts);
- Incidental or consequential damages;
- Cosmetic defects which DO NOT affect performance;
- Normal wear and tear;
- Damage due to vandalism; acts of nature, including but not limited to wind, storms, hail, floods;
- Improper assembly, installation, or use;
- Discoloration or fading of the finish as a result of exposure to chemicals, spills, pool or salt water
- Corrosion/ rust.

Your product has been designed for safety and quality.

Any modifications made to the original product could compromise its structural integrity or function, and could lead to product failure or personal injury. As such, modifying this product voids any and all warranties.

This product is warranted for RESIDENTIAL USE ONLY, and is not for commercial, contract or other non-residential purposes. Products disclaims all other representations and warranties of any kind, express or implied.

The warranty applies to the original purchaser and is non-transferable. It does not apply to purchases of display models, or when the product is sold on clearance or "as is".

We makes no warranty whatsoever in respect to accessories or parts not supplied with it. This warranty shall apply only within the boundaries of the United States of America and Canada. This warranty gives the original purchaser specific rights, and the original purchaser may also have other rights, which vary from state to state.

