

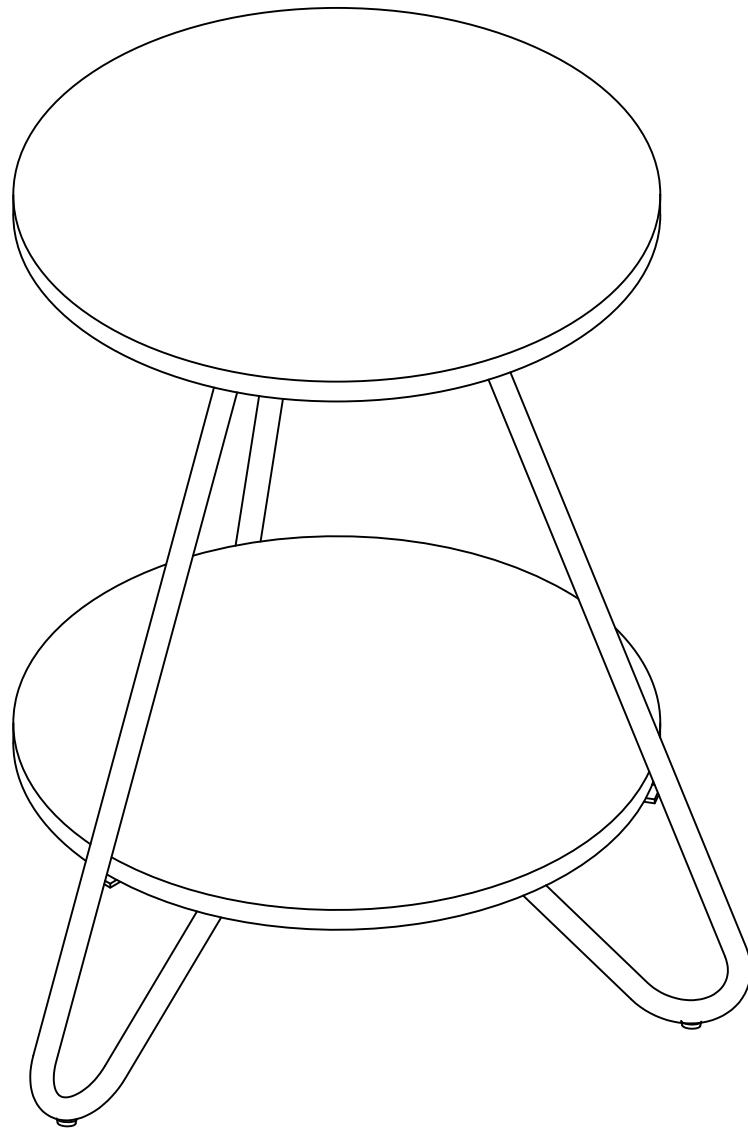

LITTLE TREE

Assembly Instructions



Model No. HOGA-J0097

Multifunctional Computer Desk

Call us!

We're here to help!

If you have any issues with this product, please contact our customer service team before returning it.



We want you to be completely satisfied with your purchase! If anything is missing, damaged, incorrect, or not what you expected, don't worry. Please keep the outer packaging and take photos of both the packaging and products, and then reach out to us at support@tribesigns.com or call us at 1-424-220-6888. We'll take care of everything and send you a free replacement, so you can enjoy your purchase as soon as possible without any hassle.

Assembly Instructions:

1. Carefully read these instructions and keep them for future reference.
2. Refer to the parts list for guidance and ensure that you have all the pieces before starting the assembly process, if anything is missing, damaged, incorrect, contact us **FIRSTLY BEFORE** assembling.
3. When assembling, place all parts on a soft, clean, and flat surface, such as a carpet, to prevent any scratches.
4. To avoid misalignment of the holes, Please don't full tighten the screws until you ensure all parts in place.

Follow Tribesign:

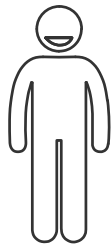

X2

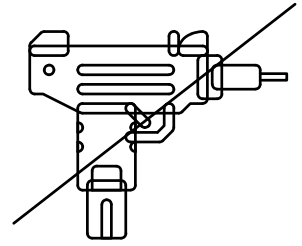
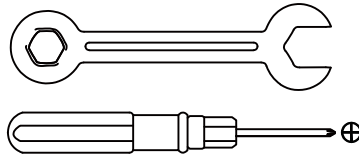

When using the electric screwdriver ,
Reduce the power and torque to avoid damaging the furniture

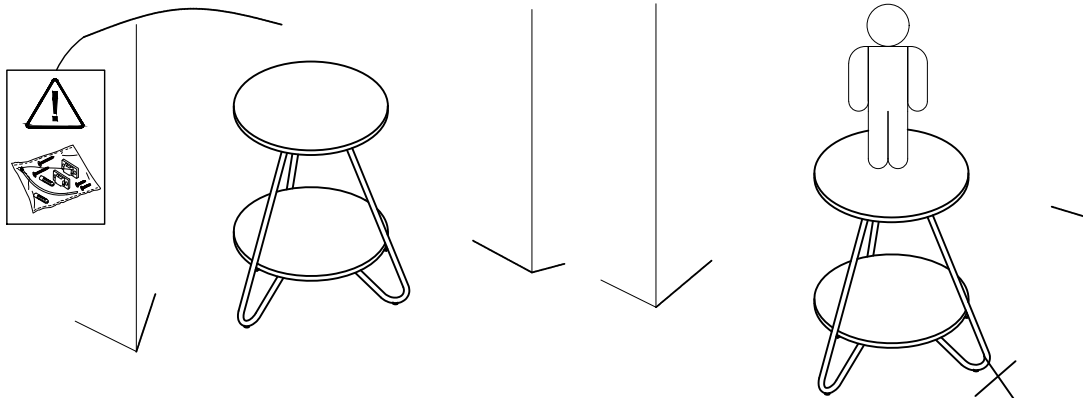
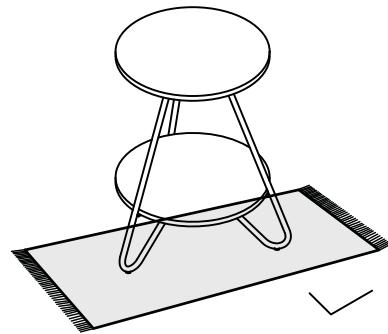
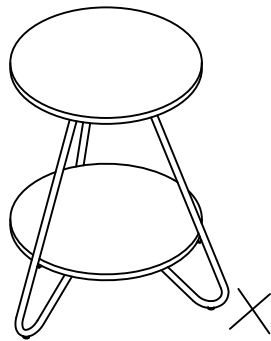
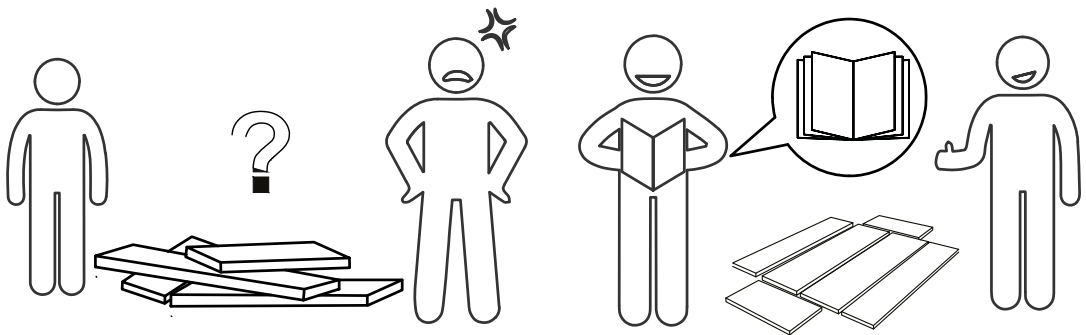

the risk of tip-over.

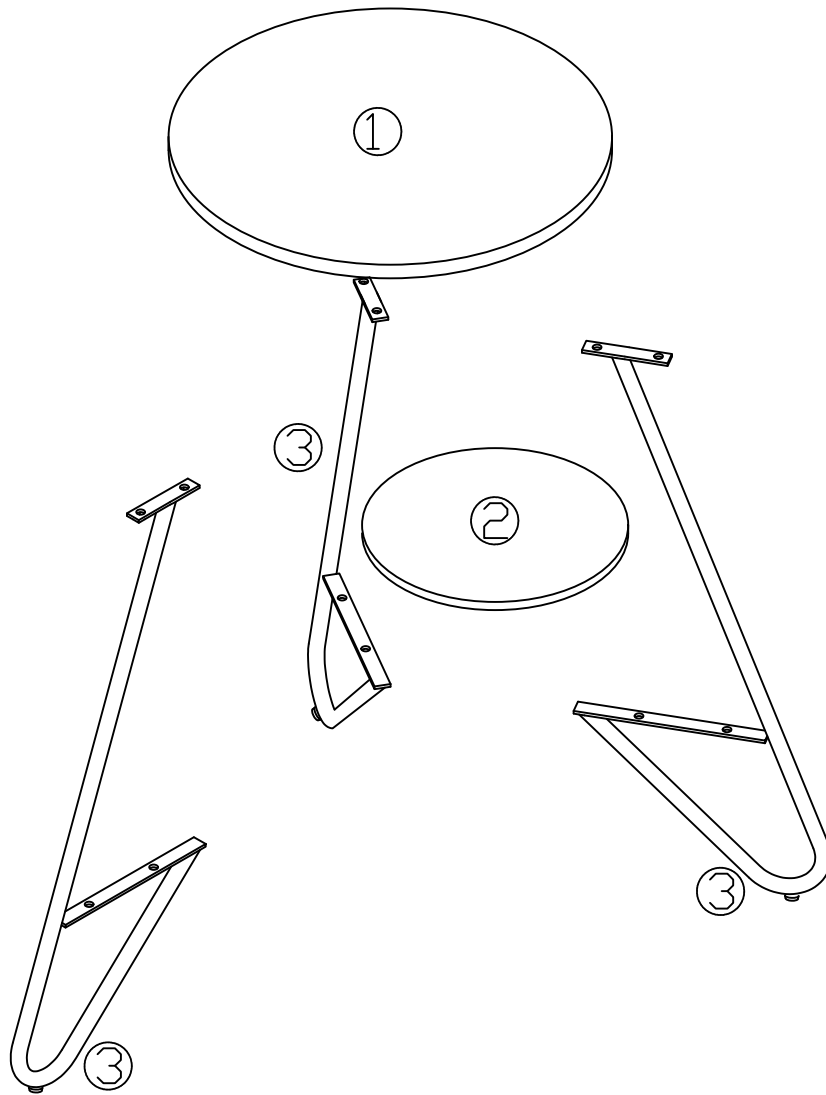

! Caution

Make sure all parts are included. Most board parts are labeled or stamped on the raw edge.

Contact us for free replacement if having damaged or missing parts.

Parts & Hardware List

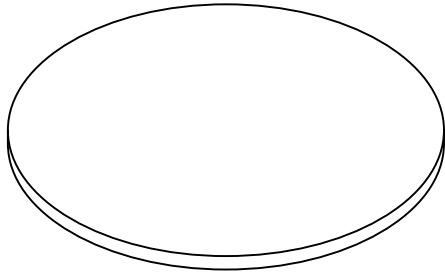

① 1PC

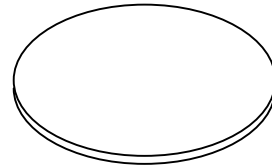

② 1PC

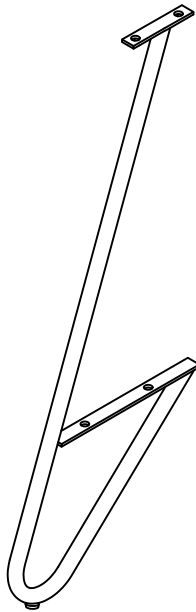

③ 3PCS

Hardware List

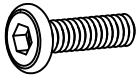
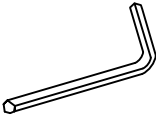
<p>A</p> <p>M6 ×12mm</p>  <p>12PCS</p>	<p>B</p>  <p>1PC</p>
---	---

①

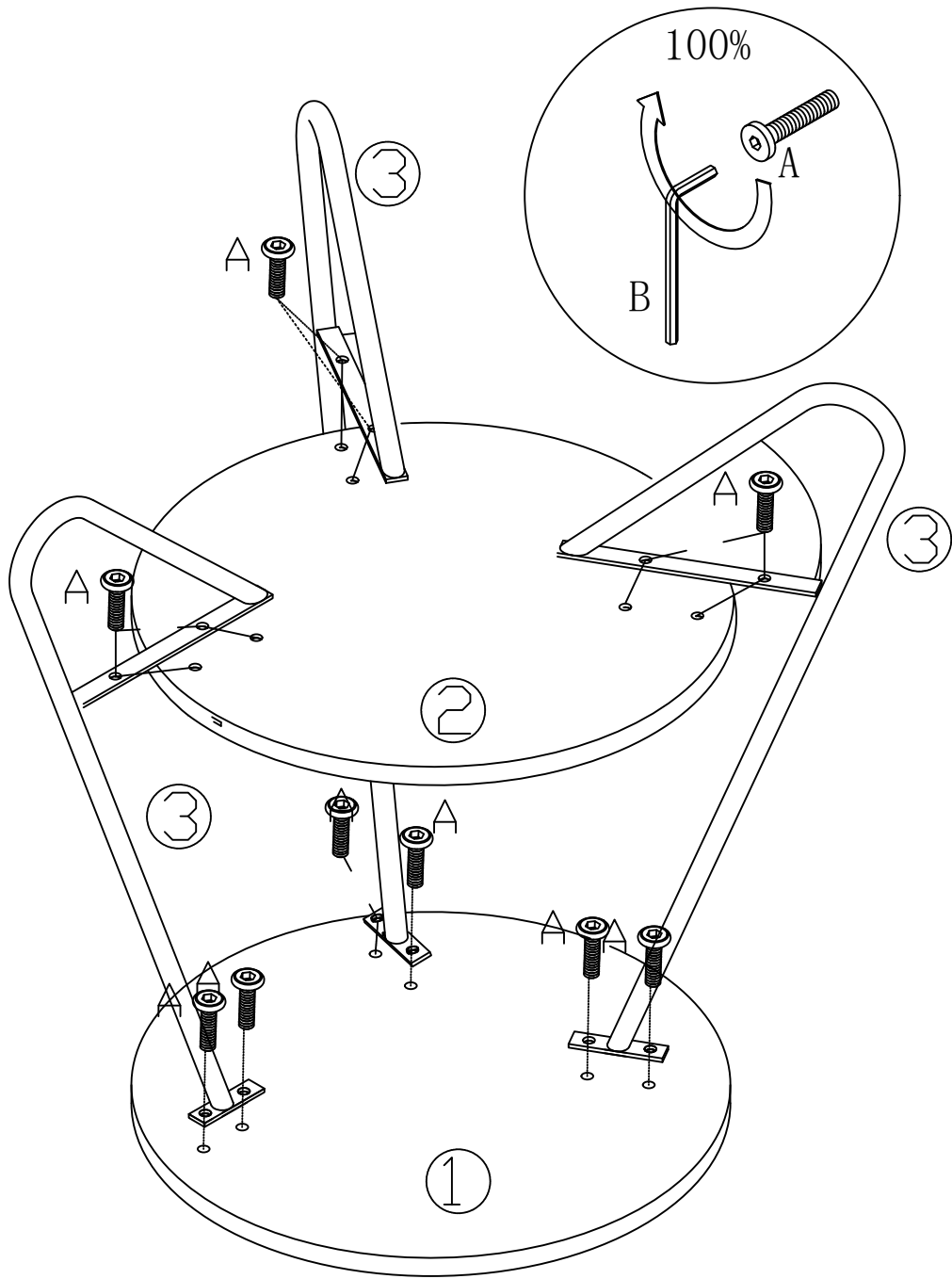

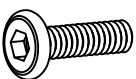
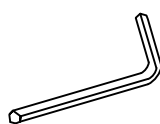
<p>A</p> <p>M6 × 12mm</p>  <p>12PCS</p>	<p>B</p>  <p>1PC</p>
--	---

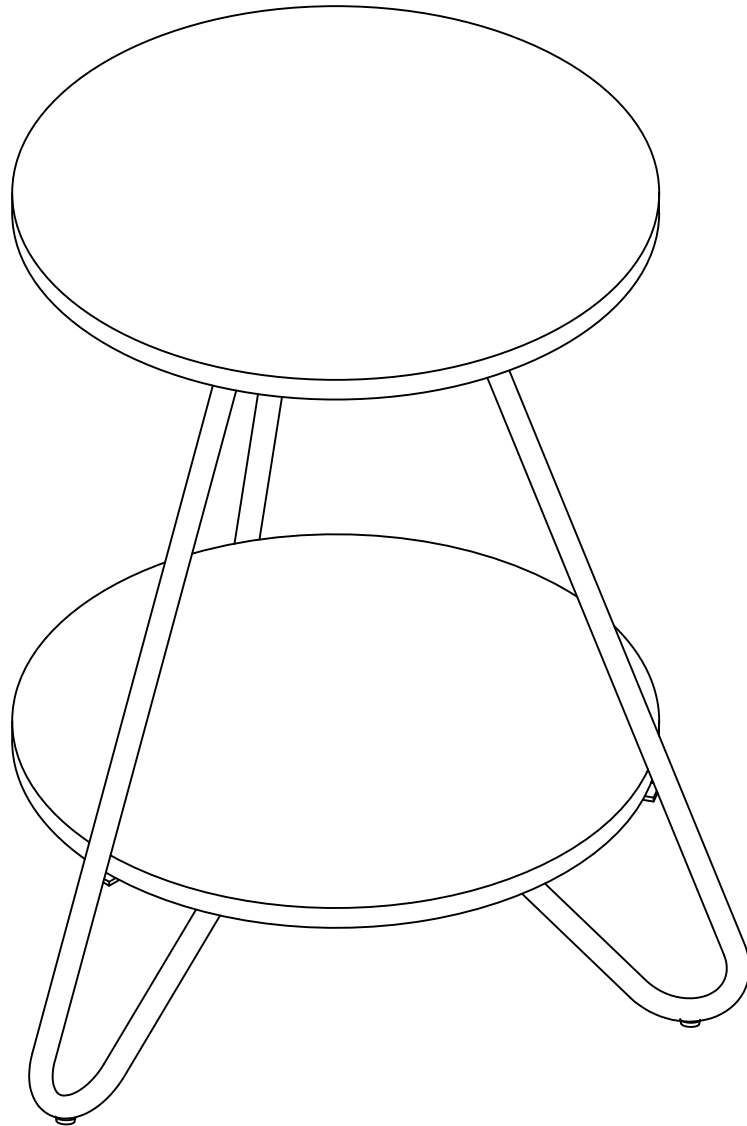

We genuinely appreciate your purchase of our product.

Any problem (installation or damage caused by shipping), please feel free to contact us. Our Customer service will help to solve the problem for you ASAP Email: support@tribesigns.com

Customer service hotline: +14242206888



No heartburn,
when we handle
the return

Our way



support@tribesigns.com



Replacement/Refund



You

Their way



Re-package item



Schedule pick-up



Track package



Replacement



You

Contact our customer service team



support@tribesigns.com
www.tribesigns.com



1-424-220-6888