

INSTRUCTIONS

ANWEISUNG

取扱説明書

INSTRUCTION

사용설명서

LSTRUZIONI PER L'INSTALLAZIONE

LIBRO DE INSTRUCCIONES

Product Name: Wedding background rack

Country of origin: Made in China

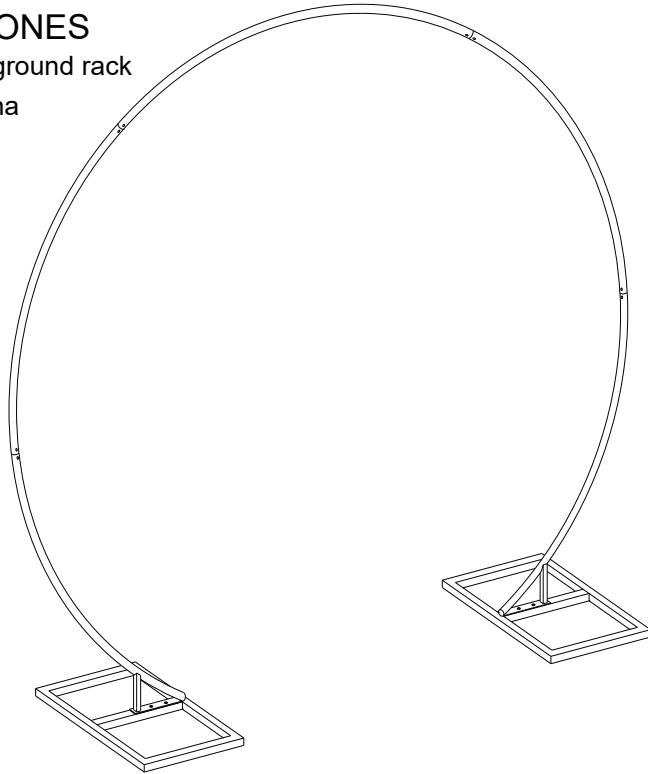

Warning :

Do not lean on it

Es ist verboten, sich an das Produkt zu lehnen.

Interdiction de s'appuyer

Non appoggiarsi al prodotto

Prohibido apoyarse

製品に寄りかからないでください。

기대지 마세요

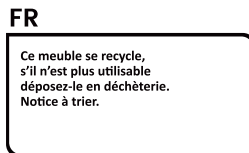

A *2

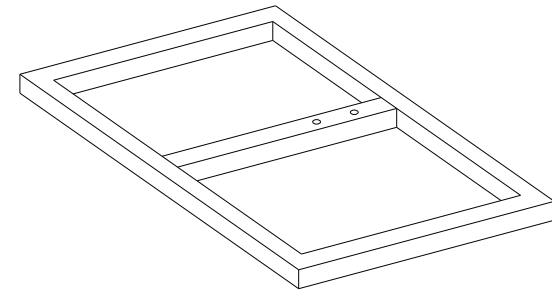

B *2

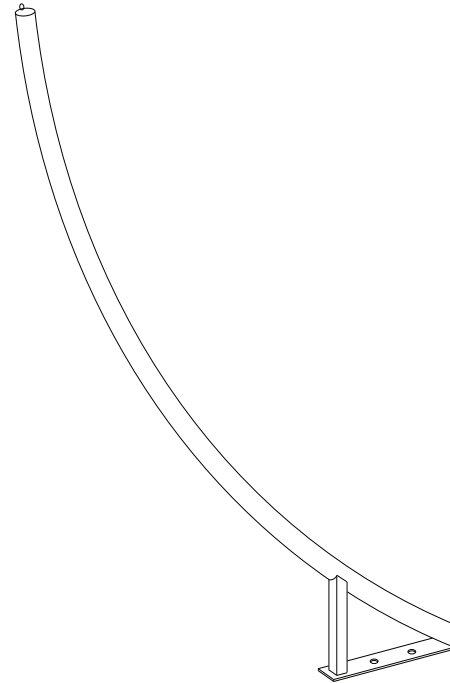

C *3

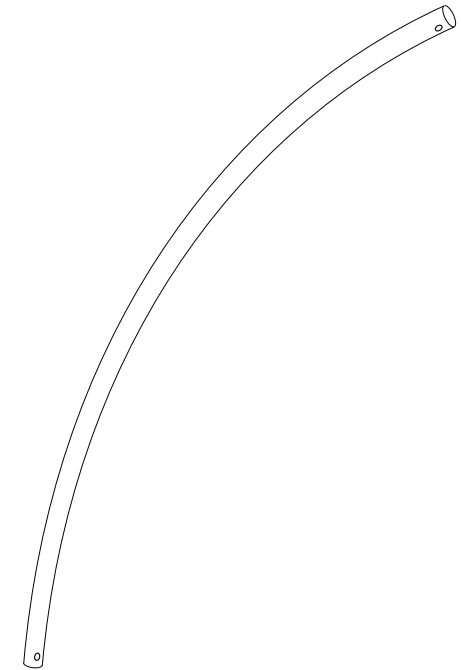

D *4

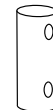

E *8



F *4

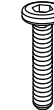

G *4



H *4



J *1

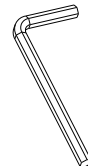

K *1



1

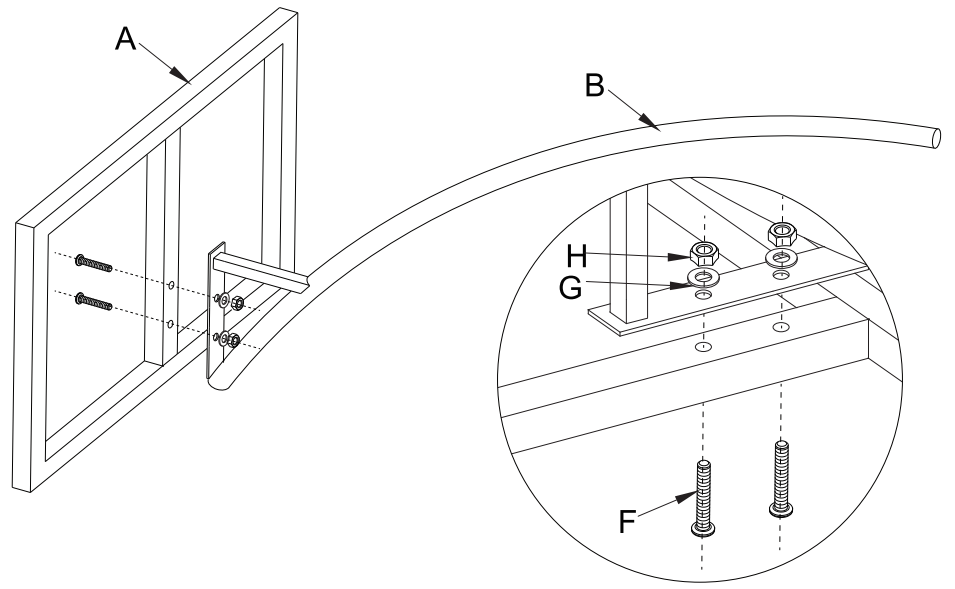
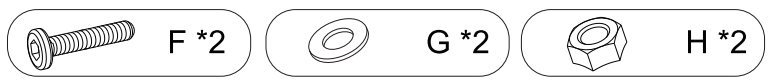

3

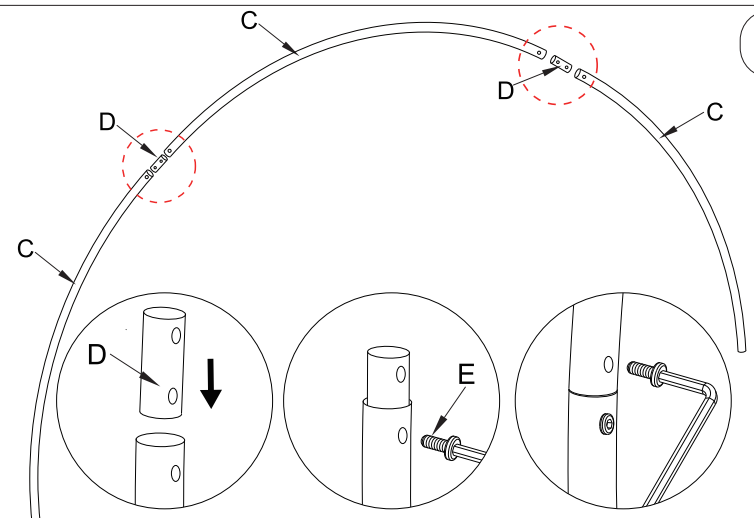

- 2.Align to the hole position, screw one part first, then fix another part
- 2.Richten Sie bitte die Löcher aus, fest zuerste die Schrauben eine Seite und befestigen Sie die andere Seite.
- 2.穴の位置を合わせて、1つの部分をネジで固定して、次に別の部分を固定します。
- 2.Veuillez aligner les trous, serrer les vis d'abord d'un côté et fixer l'autre côté.
- 2. 구멍 위치에 맞춰 한쪽 부분을 먼저 나사로 고정한 후 다른 부분을 고정하십시오
- 2.Allineare i fori, stringere prima una parte, poi fissare l'altra parte.
- 2.Alinee los agujeros, primero apriete una parte y luego fije la otra parte.

2

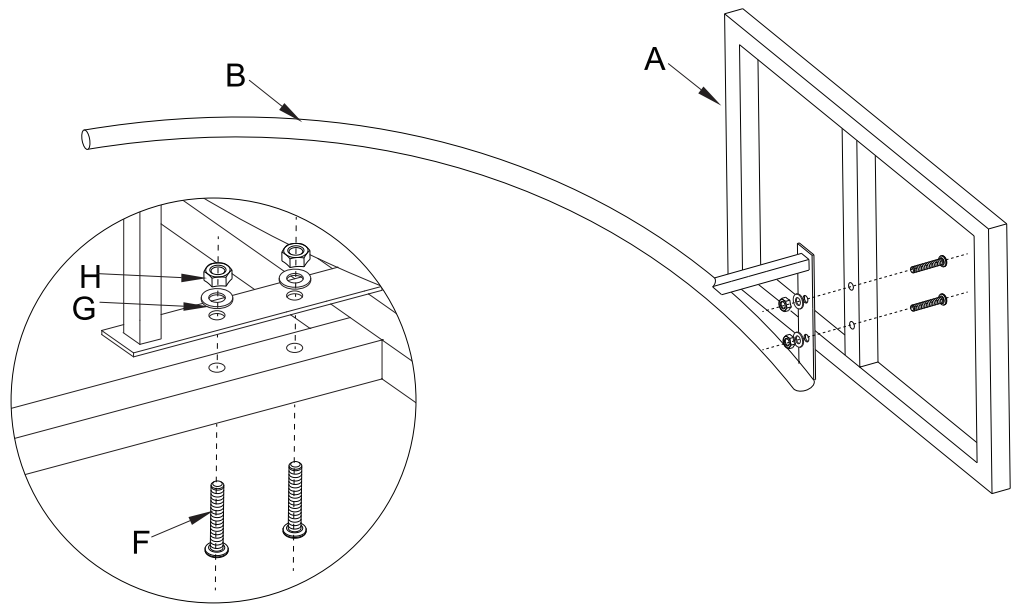

4

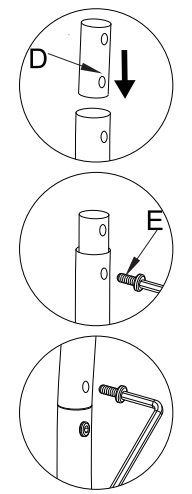
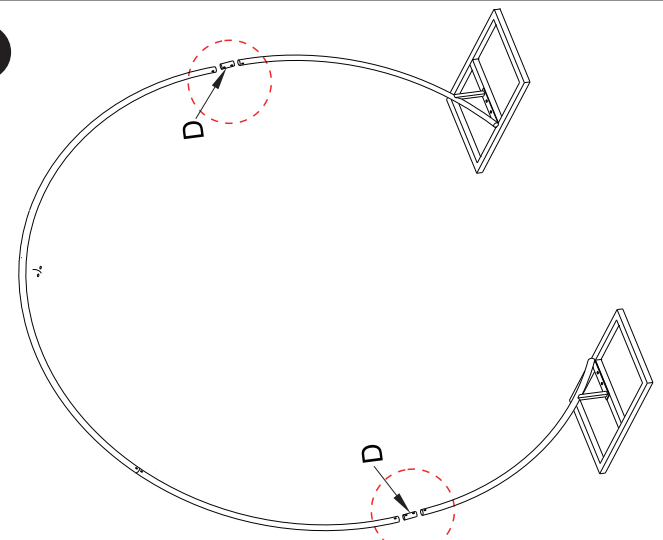

- 4.Placing it on the ground for installation, then pick it up after installation done.
- 4.Bitte installieren Sie es auf dem Boden.
- 4.地面で商品を組立てし、組立て完了したら持ち上げます。
- 4.Veuillez l'installer sur le sol.
- 4.설치를 위해 땅바닥에 놓은 다음에 설치하십시오.
- 4.Posizionarlo a terra per l'installazione, quindi sollevarlo una volta completato.
- 4.Colóquelo en el suelo para la instalación y luego levántelo después de completarla.