

Assembly Instruction

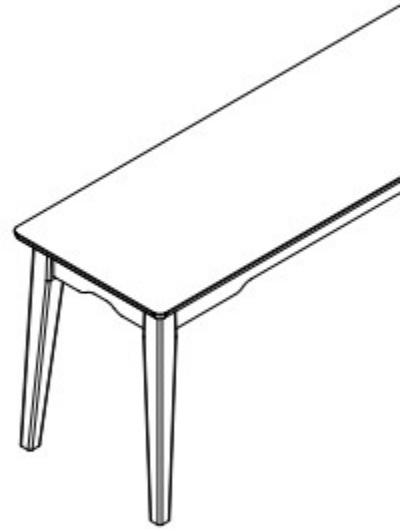

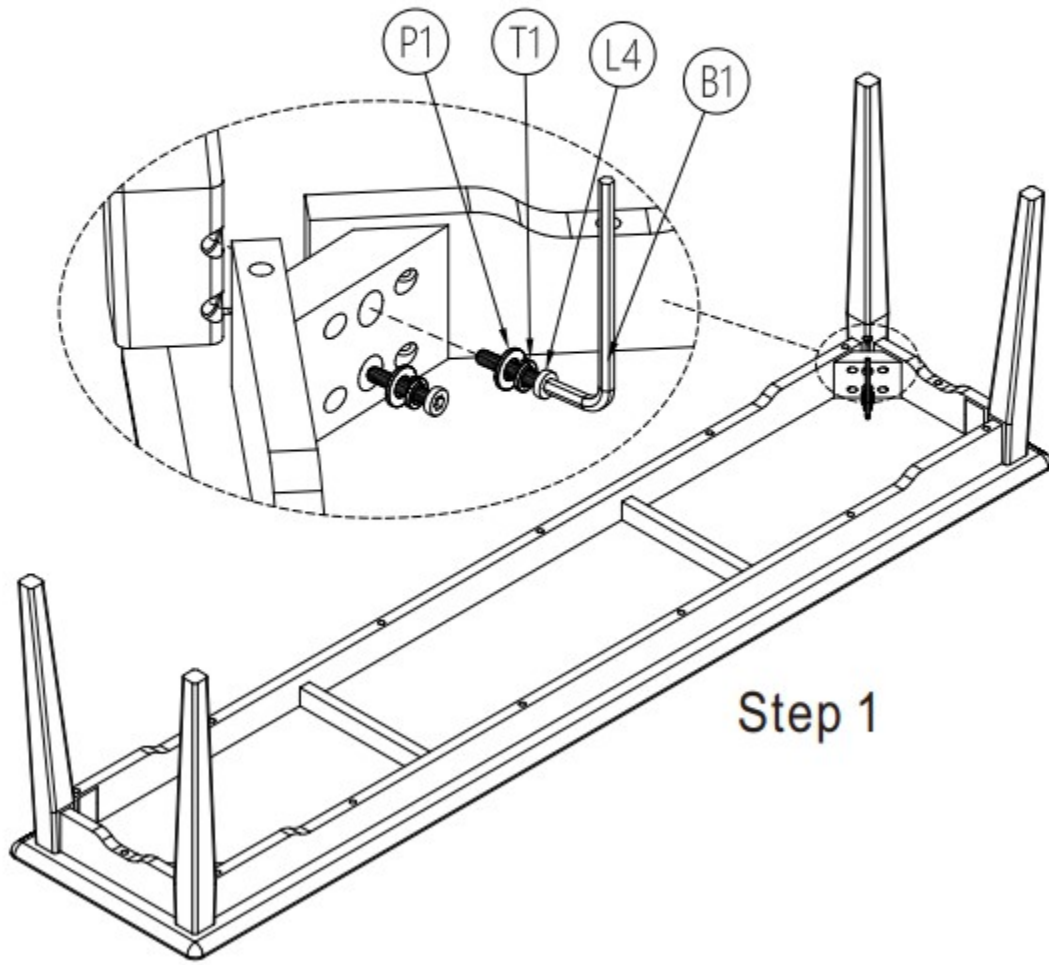
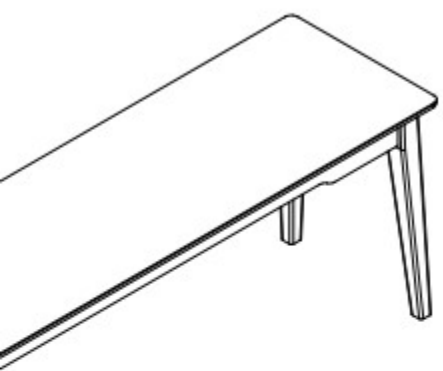

Step 2