

# Record Player Stand Instruction Manual

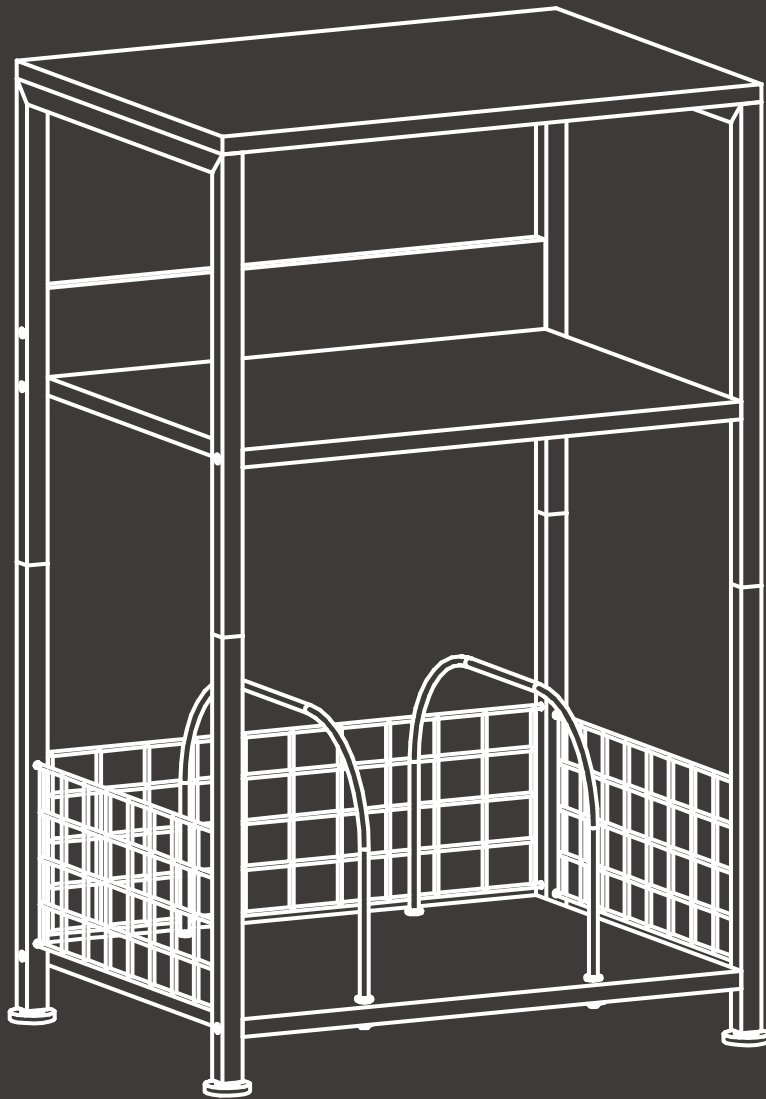

# 1 Parts List

---

**1** X1

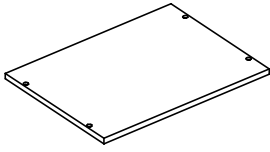

**2** X1

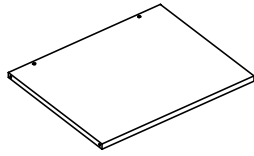

**3** X1

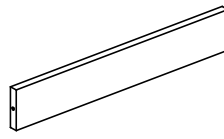

**4** X1

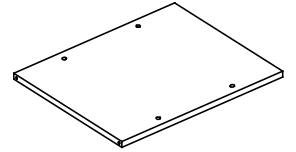

**5** X2

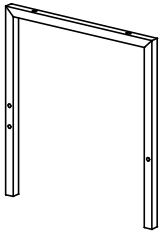

**6** X1

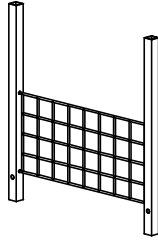

**7** X1

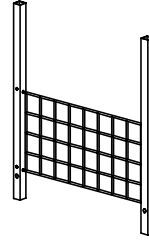

**8** X1

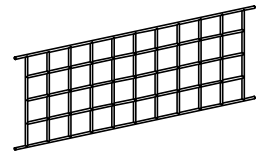

**9** X2

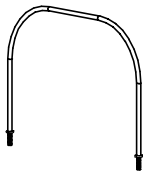

**10** X4

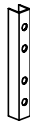

## 2 Hardware

---

**A** X16



M6X10

**B** X4



M6X22

**C** X12

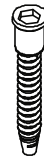

M5X40

**D** X4



M6

**E** X4



M6

**F** X1

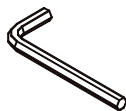

M4

**G** X1

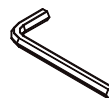

M3

**H** X1



# 3 Assembly Instruction

## Step 1

**NOTE** Partially tighten screws first. Fully tighten after assembly.

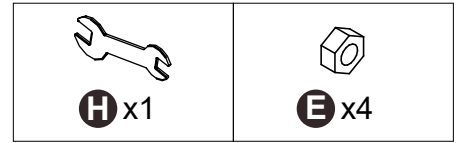
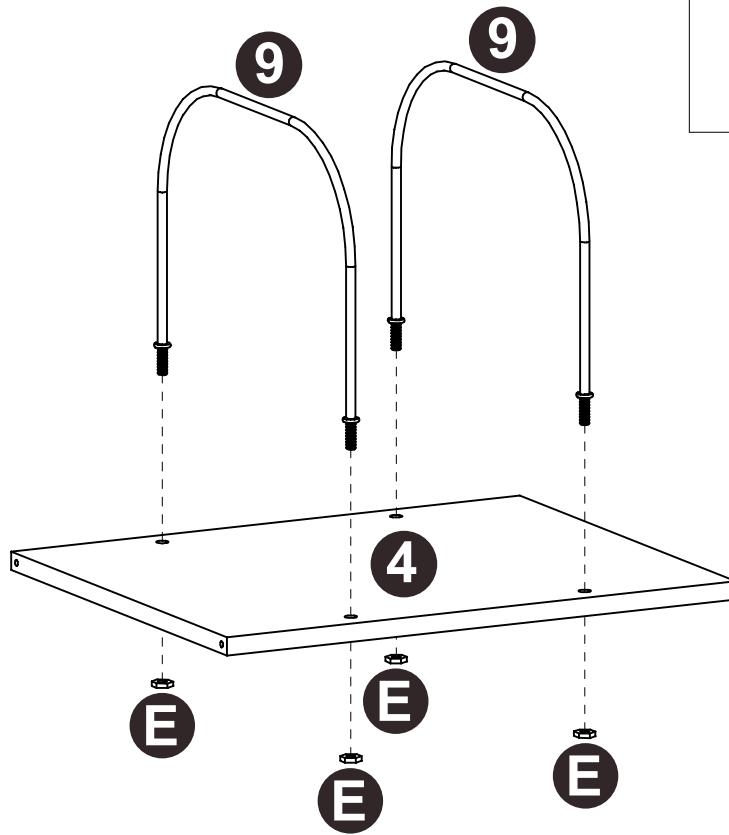

## Step 2

Holes facing backward

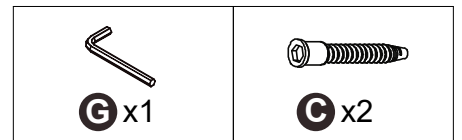
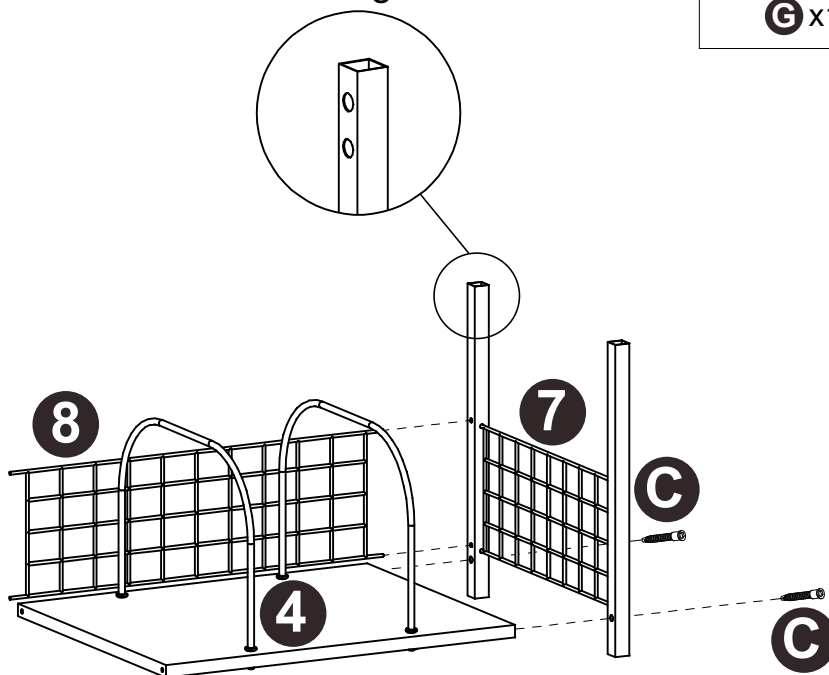

# Step 3

Holes facing backward

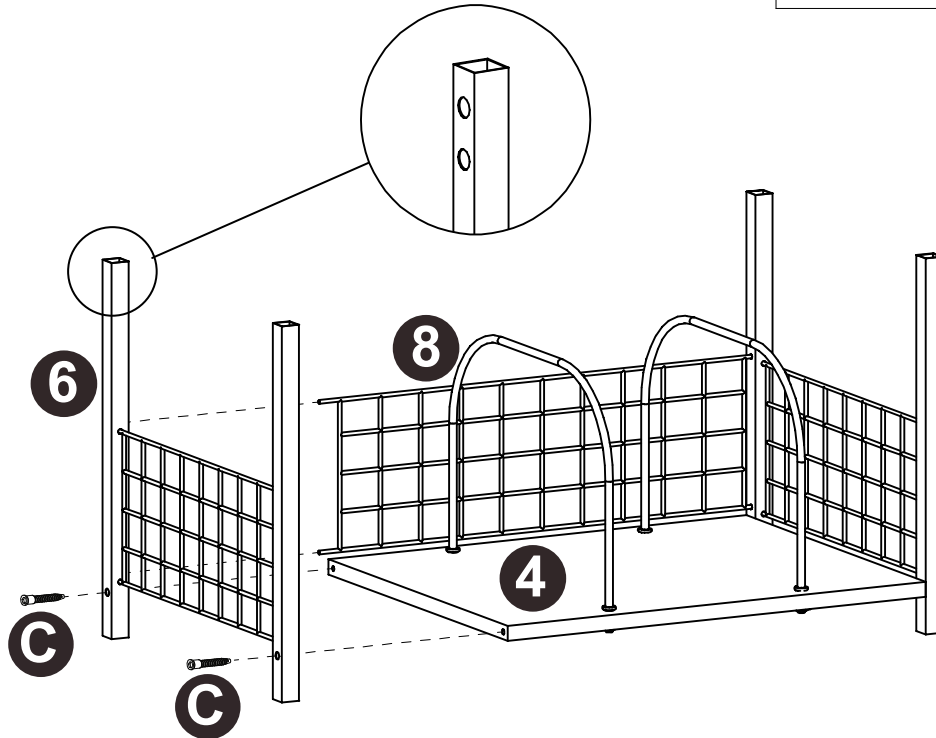
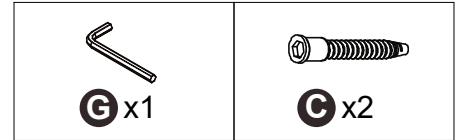

# Step 4

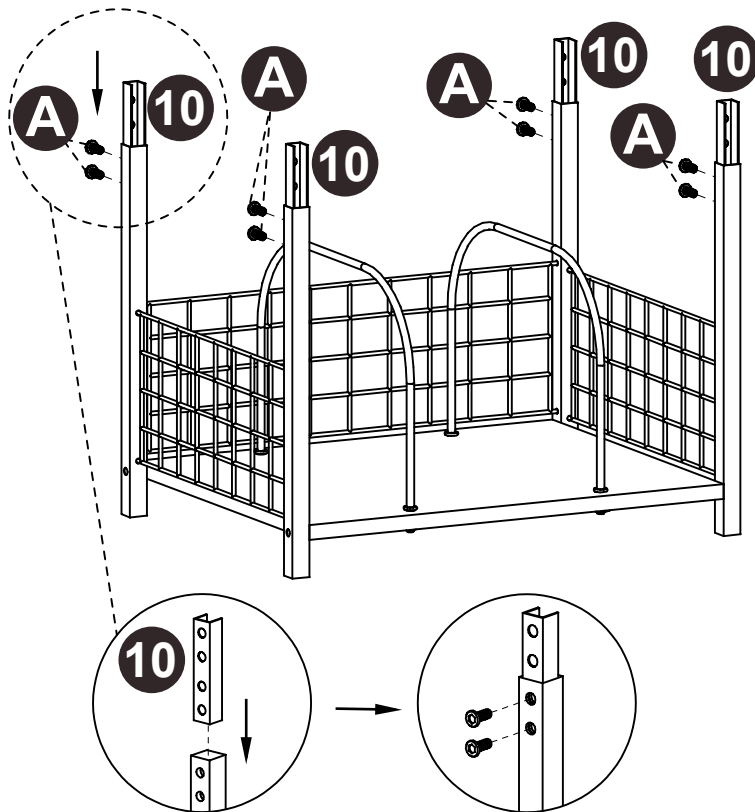
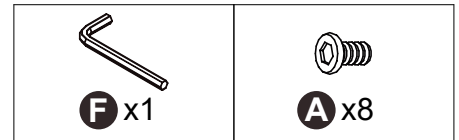

# Step 5

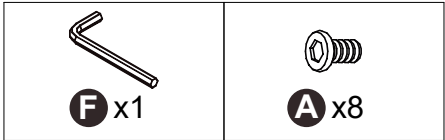
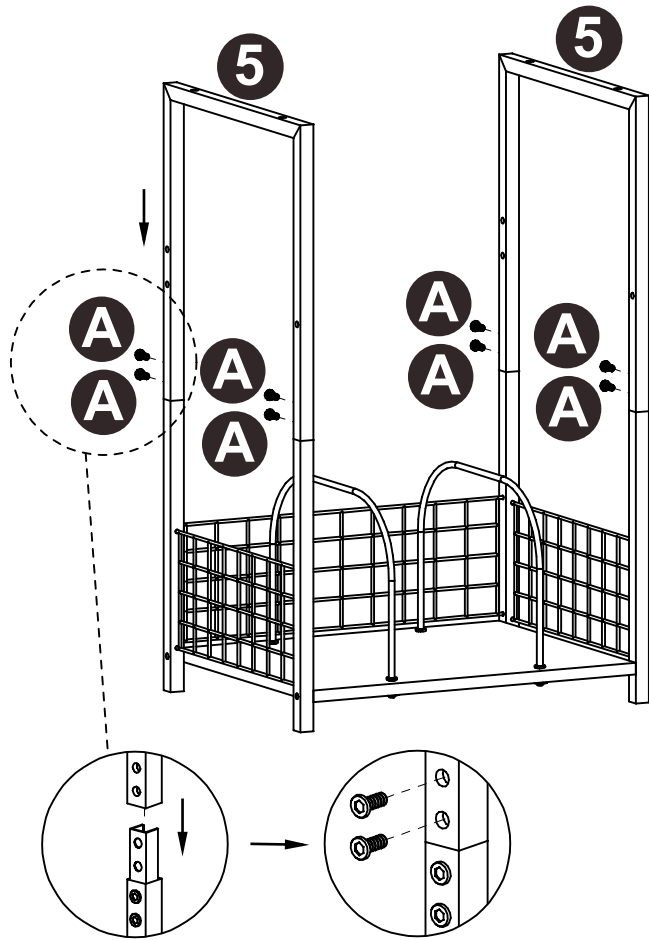

# Step 6

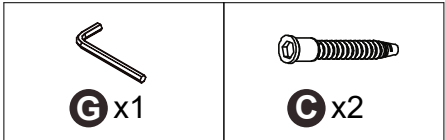
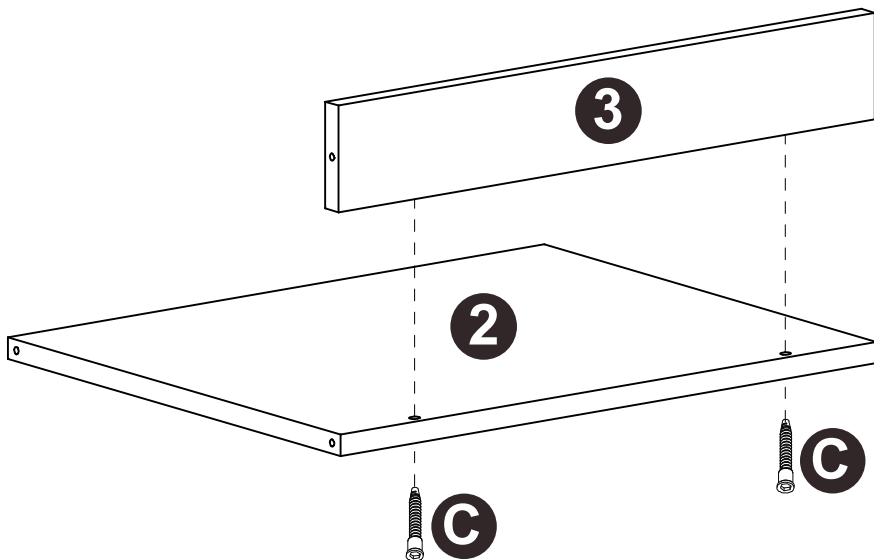

# Step 7

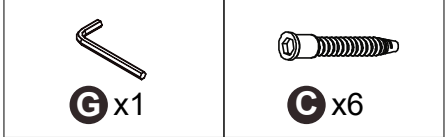
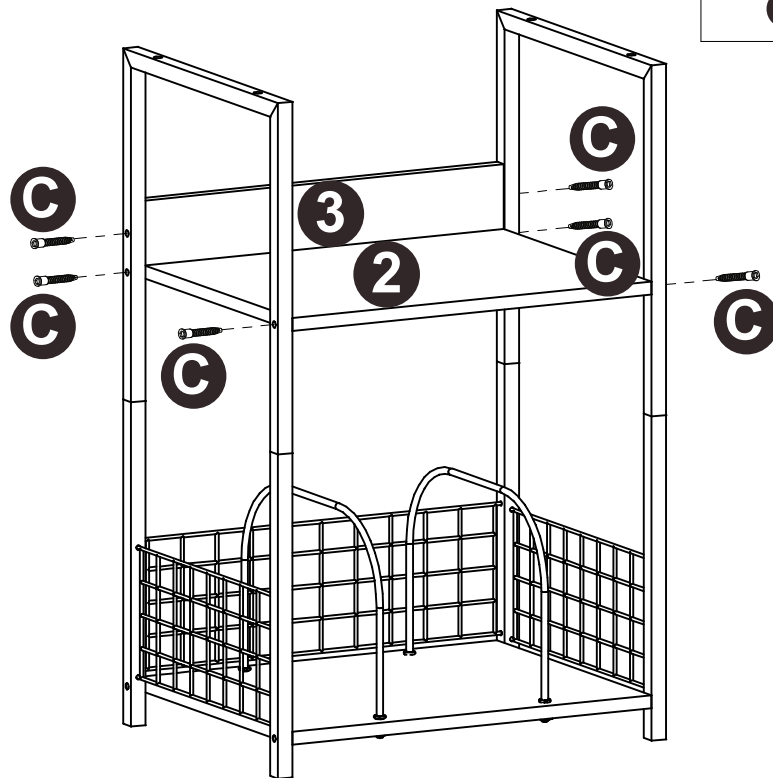

# Step 8

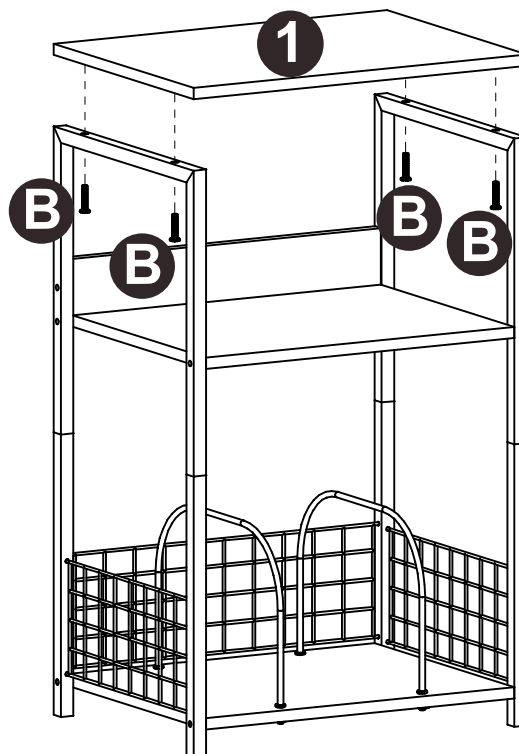

# Step 9

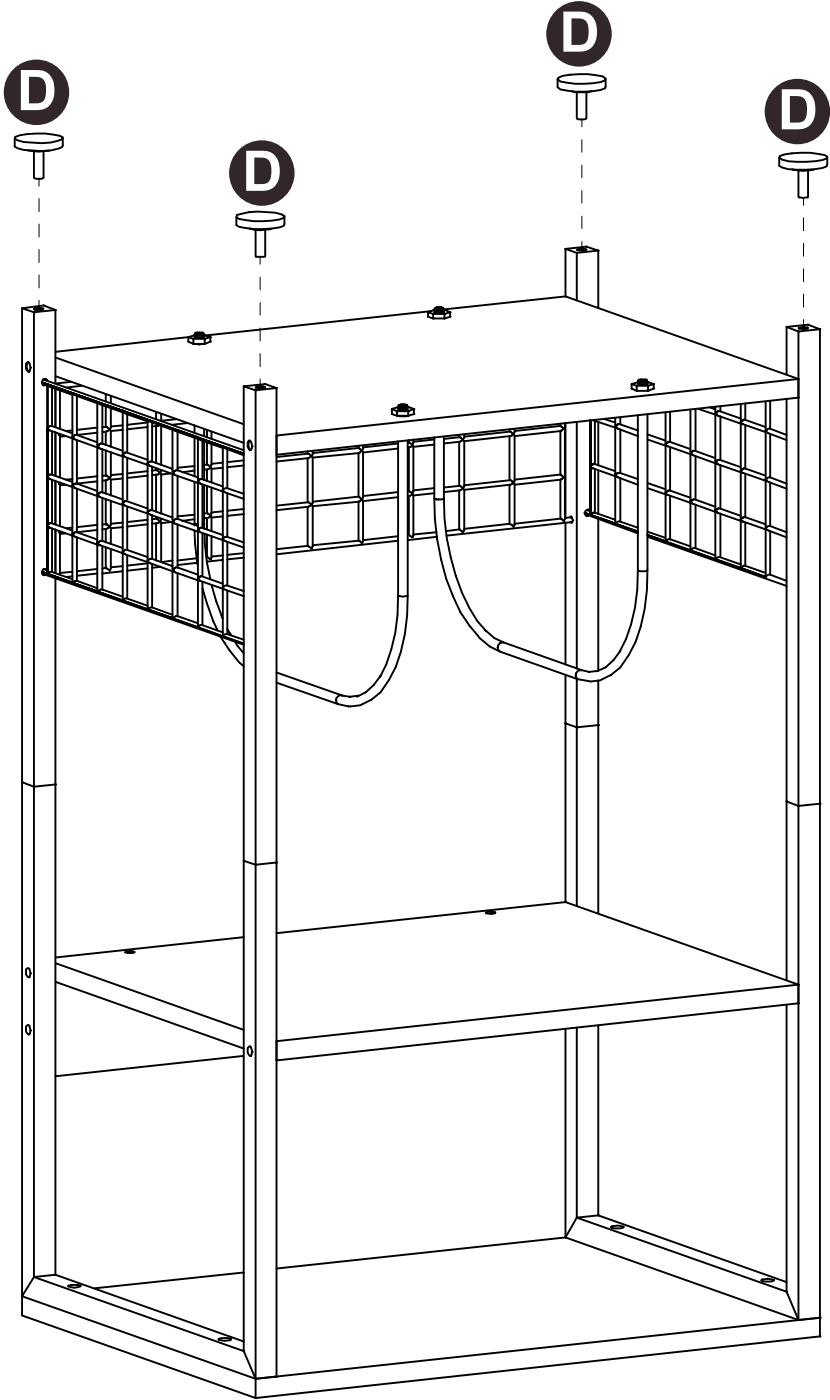

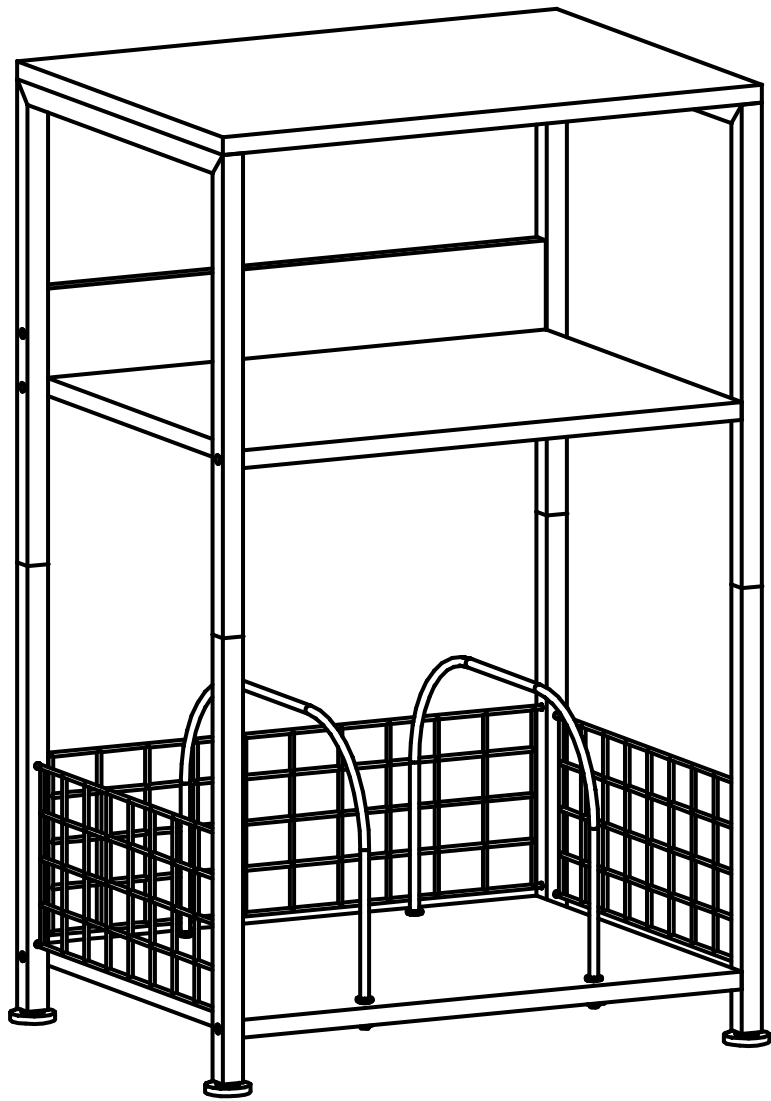

Thank you for choosing this product. We strive to provide you with the best quality products and service in the industry. Should you have any issues, please don't hesitate to contact us.