

ASSEMBLY INSTRUCTIONS

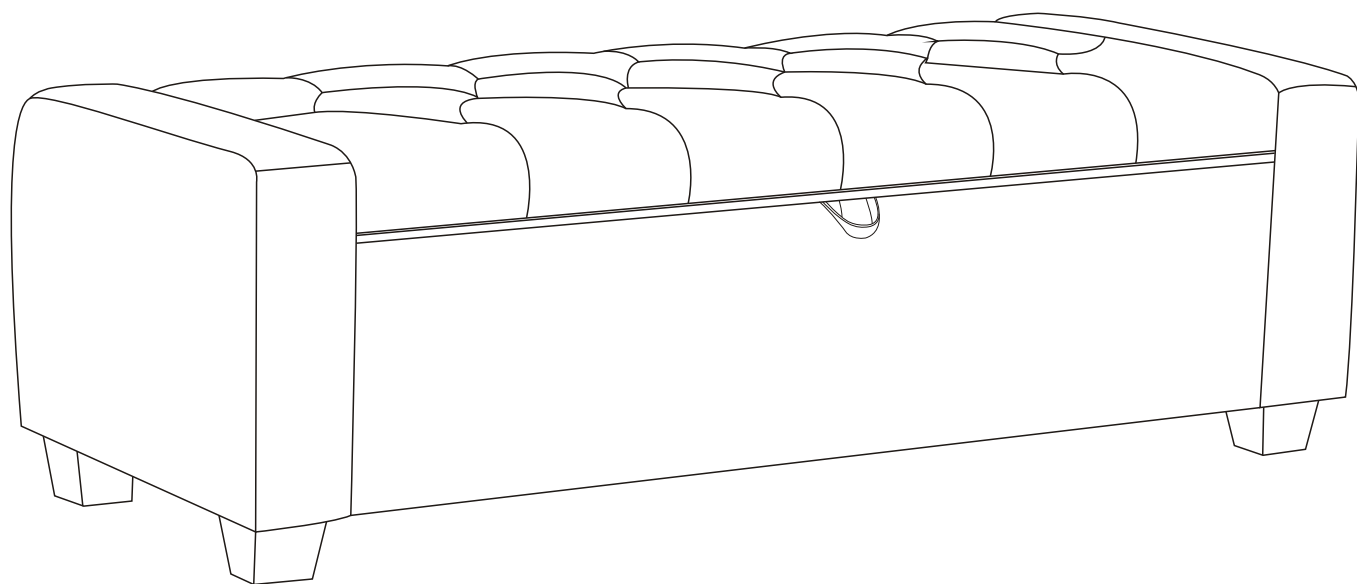



B S 9 0 1 9

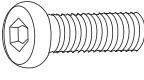
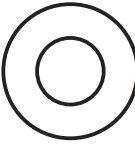
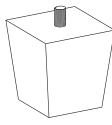

PARTS

Assembly Steps | Montageschritte

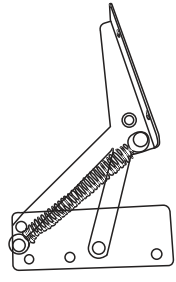
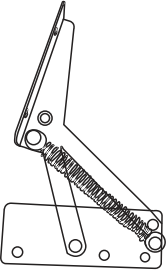
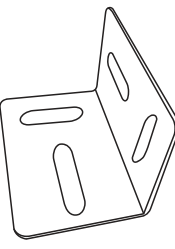
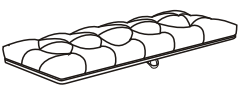
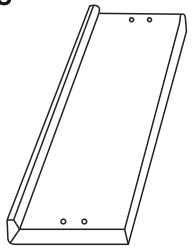
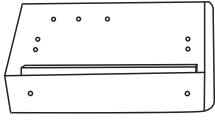
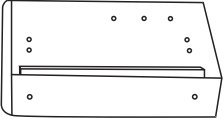
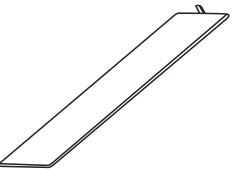

<p>A</p>  <p>Φ6X16MM</p> <p>x26+1</p>	<p>B</p>  <p>x16+1</p>	<p>C</p>  <p>x4</p>	<p>D</p>  <p>x1</p>	<p>E</p>  <p>x4</p>	<p>F</p>  <p>x1</p>
<p>G</p>  <p>x1</p>	<p>H</p>  <p>x4</p>	<p>I</p>  <p>x1</p>	<p>J</p>  <p>x1</p>	<p>K</p>  <p>x1</p>	<p>L</p>  <p>x1</p>
<p>M</p>  <p>x1</p>					

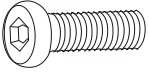
1

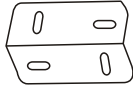
A  Φ6X16MM 8	B  8	H  4
---	---	--

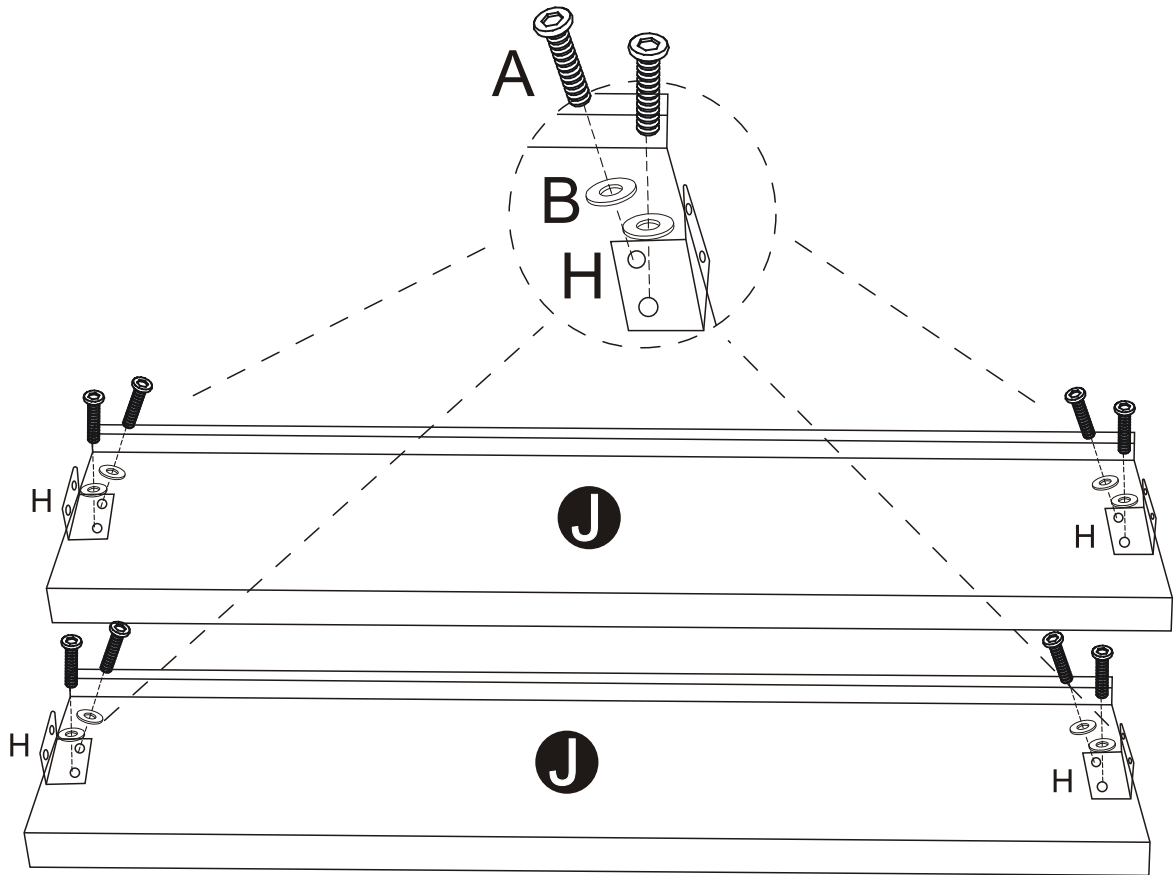

2

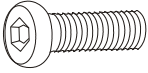
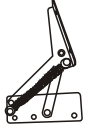
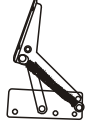
A  Φ6X16MM 6	F  1	G  1
--	---	---

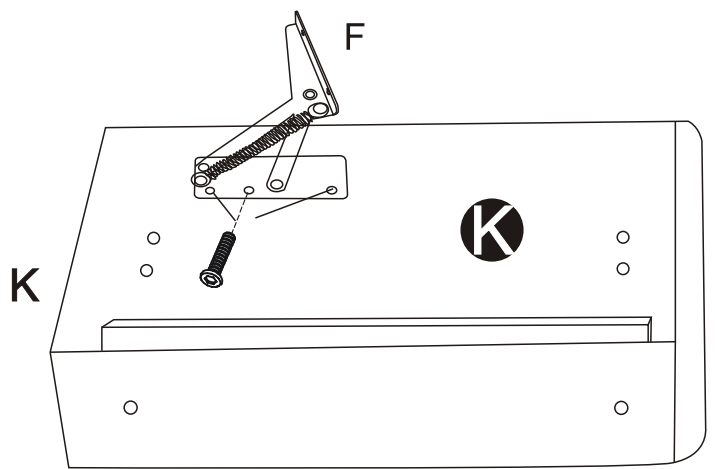
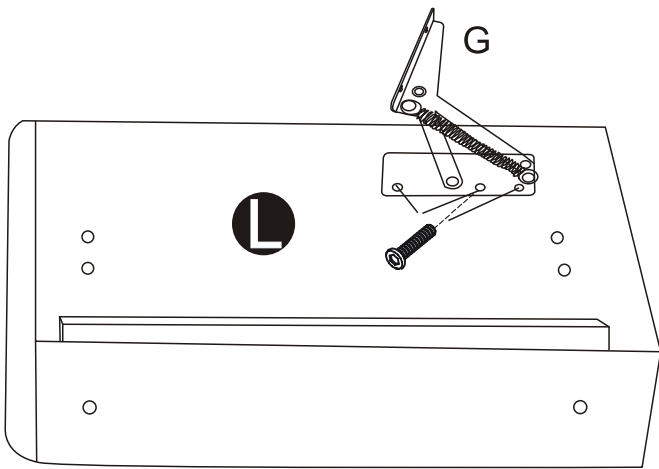

3

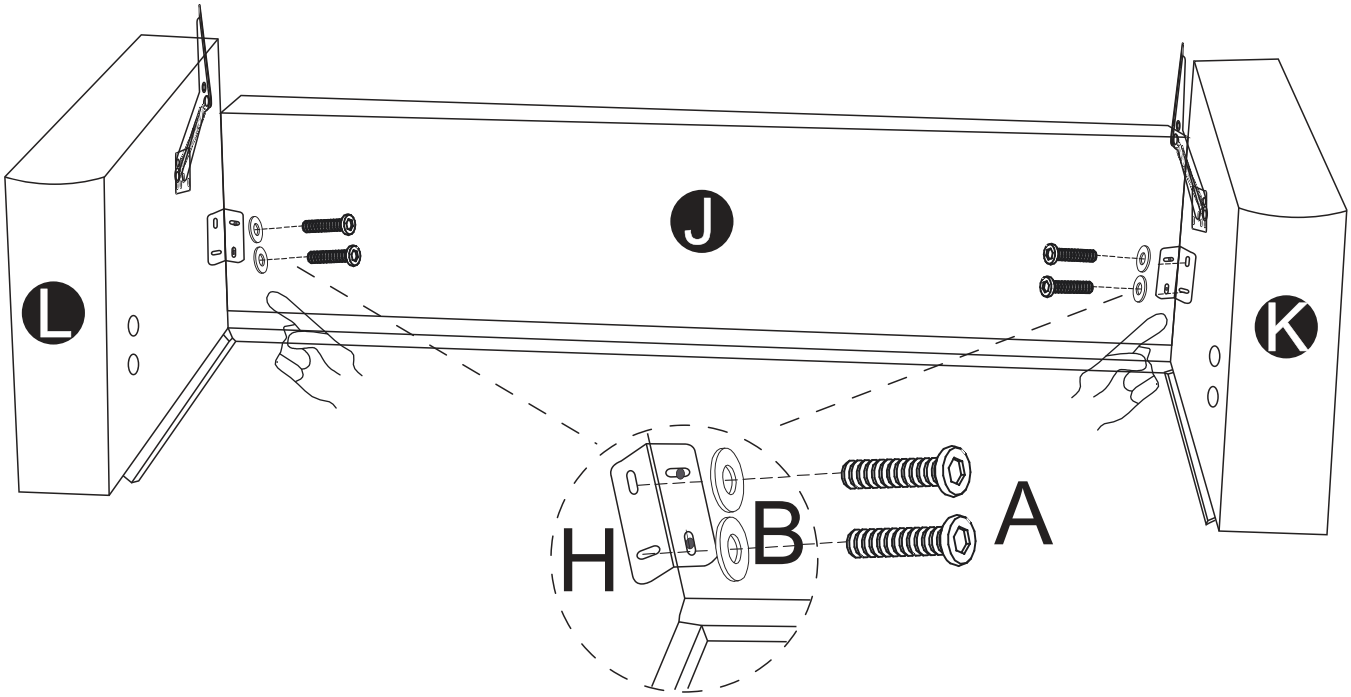
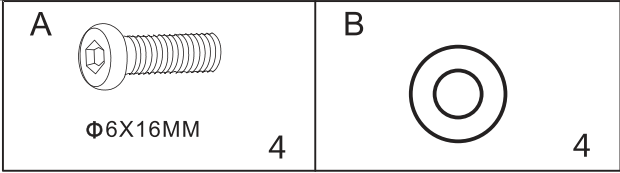

Tighten the screws 50% firstly, and lighten the screws 100% after assembling.

4

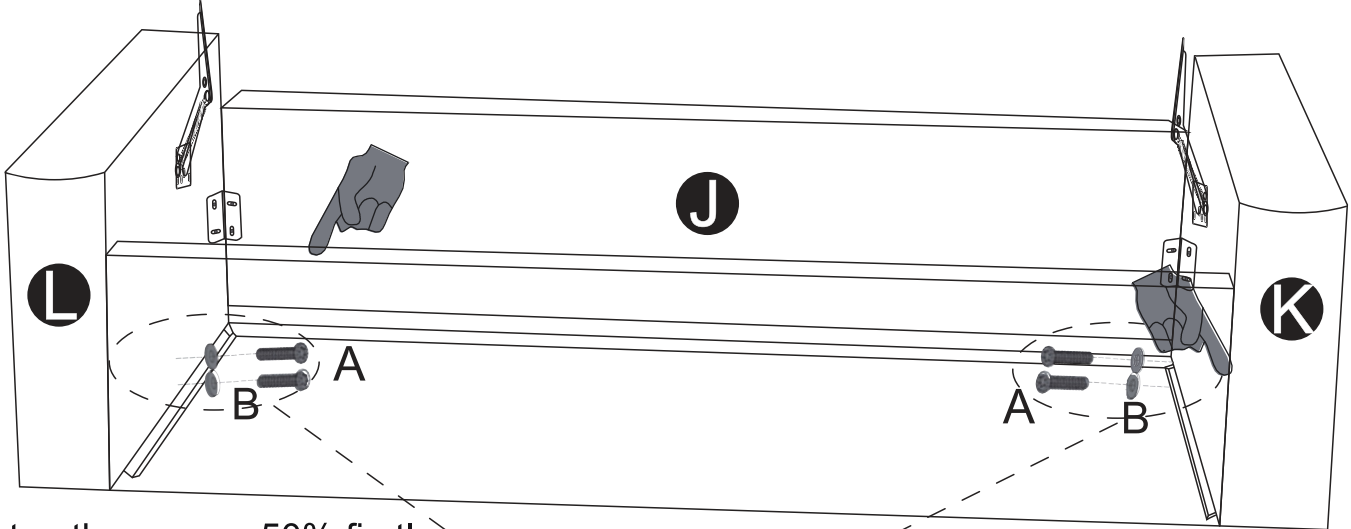
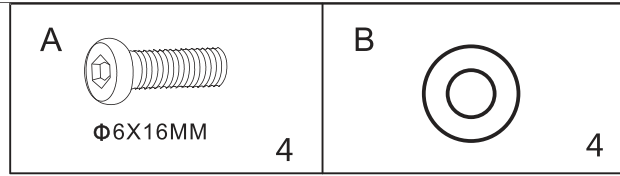

Tighten the screws 50% firstly and lighten the screws 100% after assembling.



The screws are installed on the inside

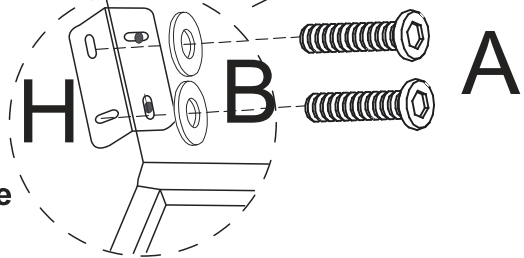

5

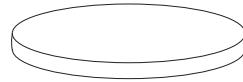
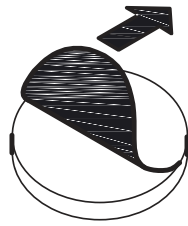
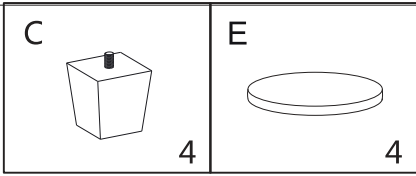

Peel off the adhesive backing

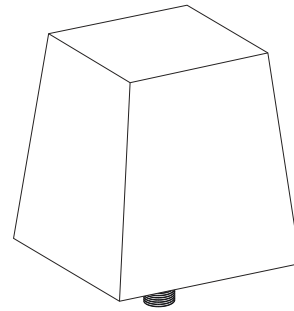

C+E

6

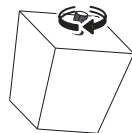
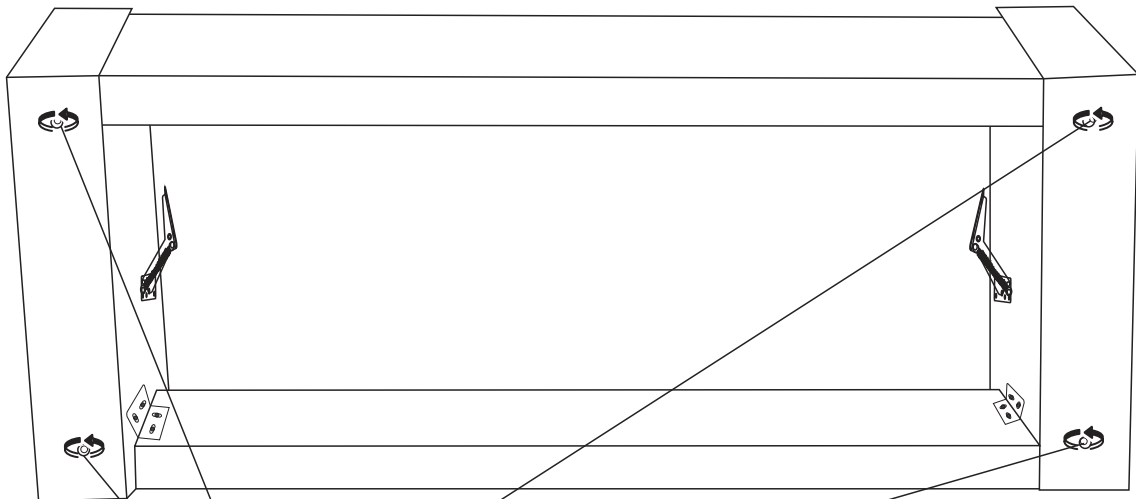
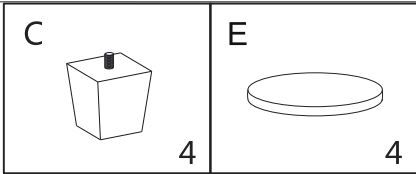

C+E

7

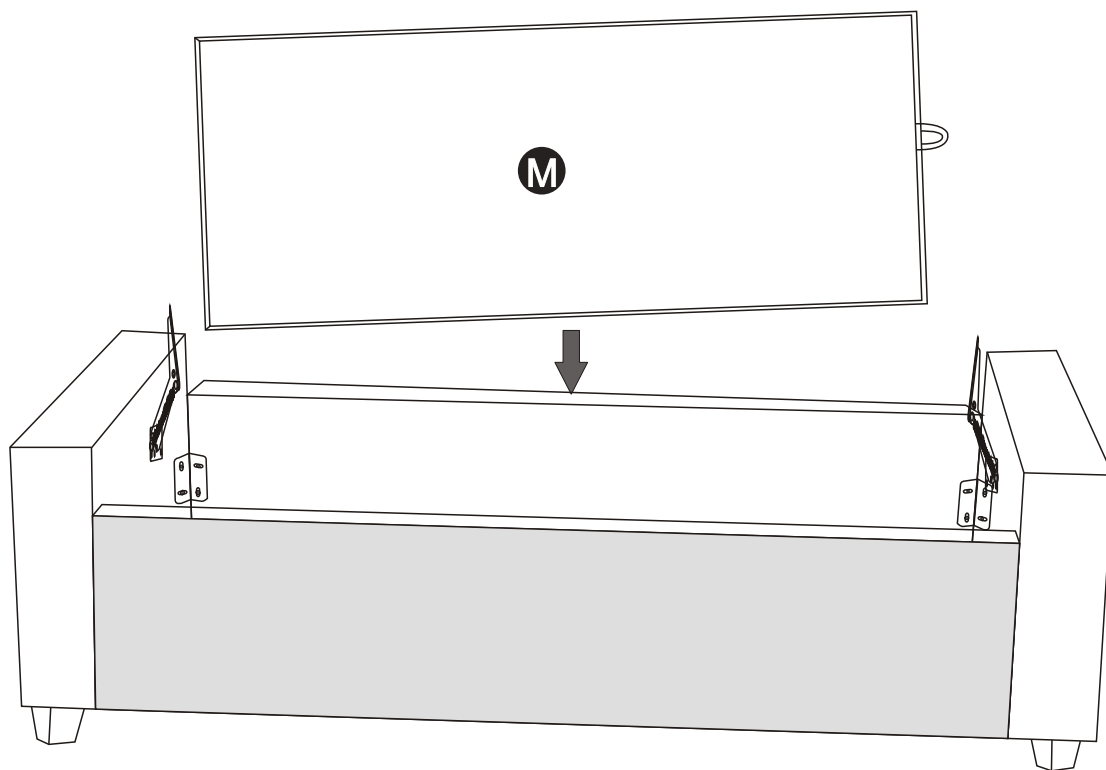

8

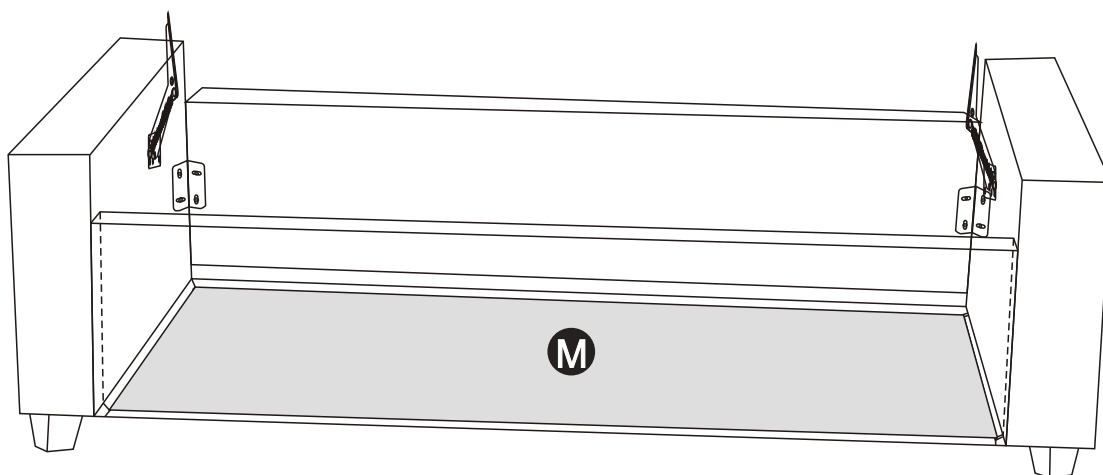

9

A

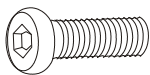

Φ6X16MM

4

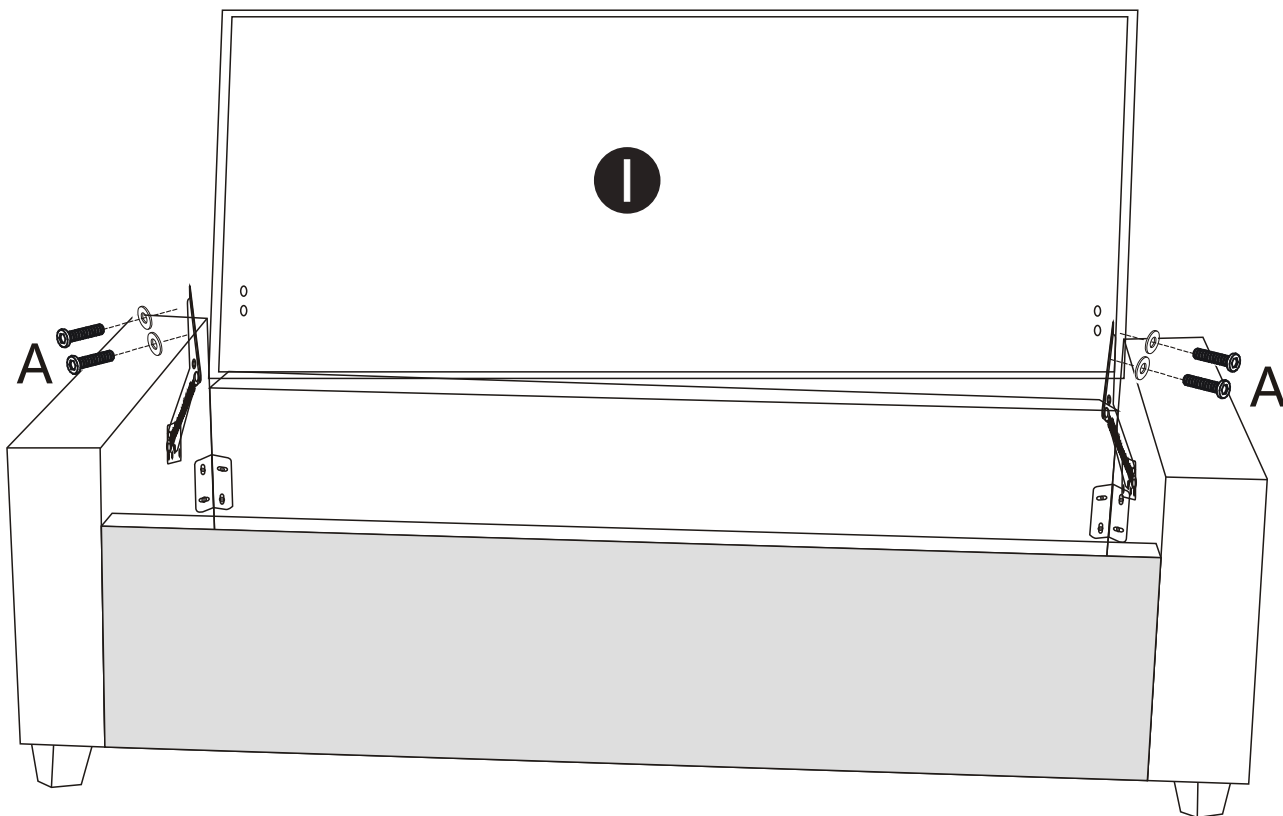

10

