

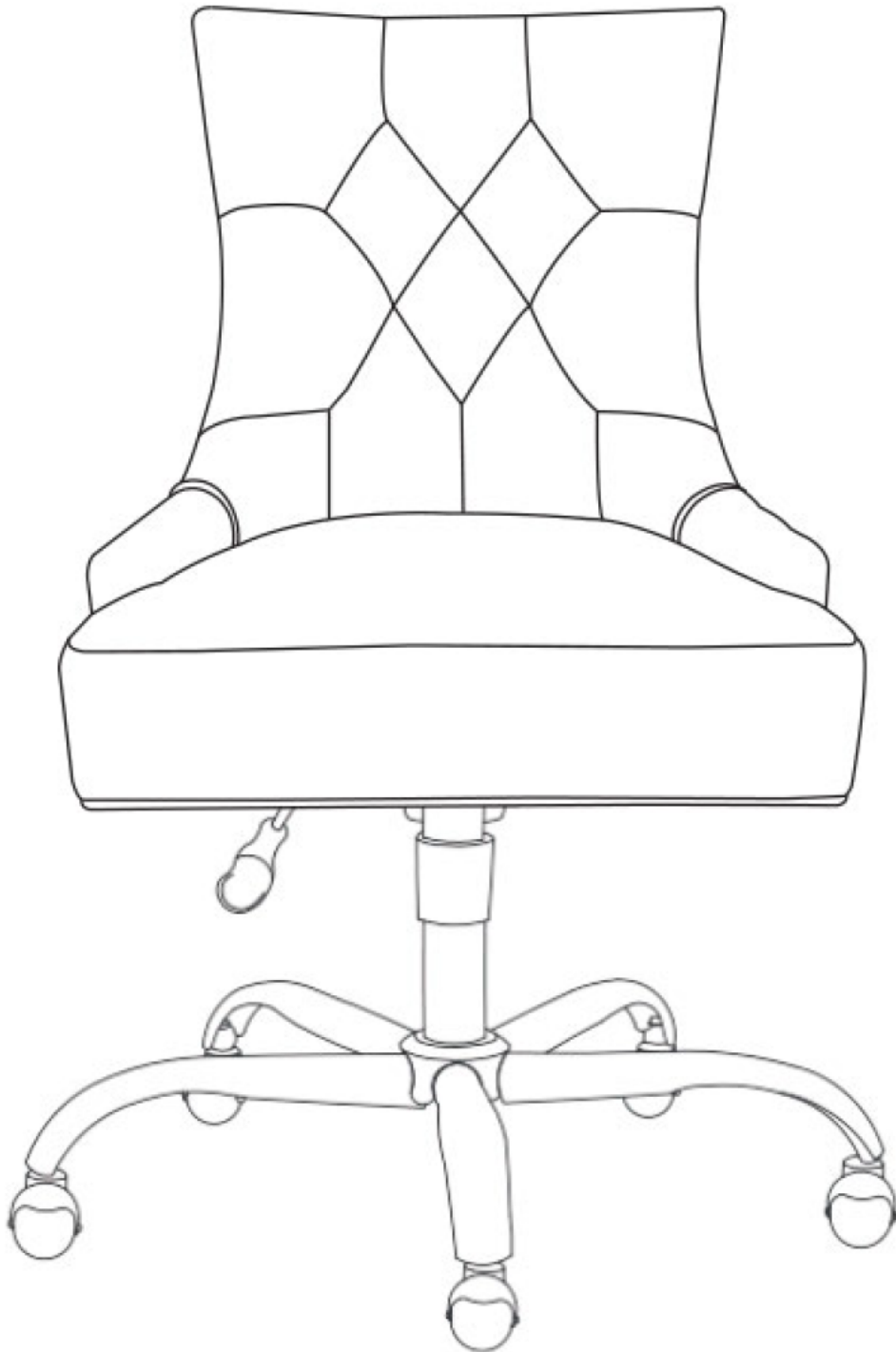





Assembly Instructions

Caution: You must read this before you proceed





Office Chair



Parts List

Label	Picture	Description	QTY
A		Chair Seat	1
B		Mechanism	1
C		Gaslift	1
D		Chrome Base	1
E		Caster	5

Hardware

①		Bolt (M8*30mm)	5
②		Washer	5
③		Spring Washer	5
④		Allen Key	1

Assembly Preparation

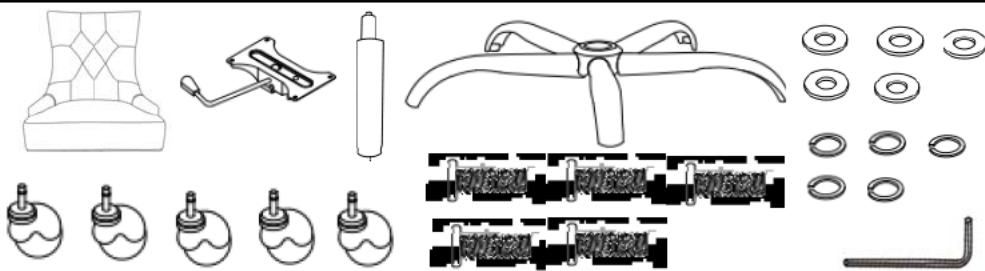
<p>Before Beginning Assembly:</p>	
-----------------------------------	--



- Read instructions, cover to cover-



- Have 2 adults on hand for assembly-



- Do not assemble on flooring or carpet-



- Assemble on a clean non-marring surface (packing foam)-



- Save all packaging until finished-

Assembly Steps

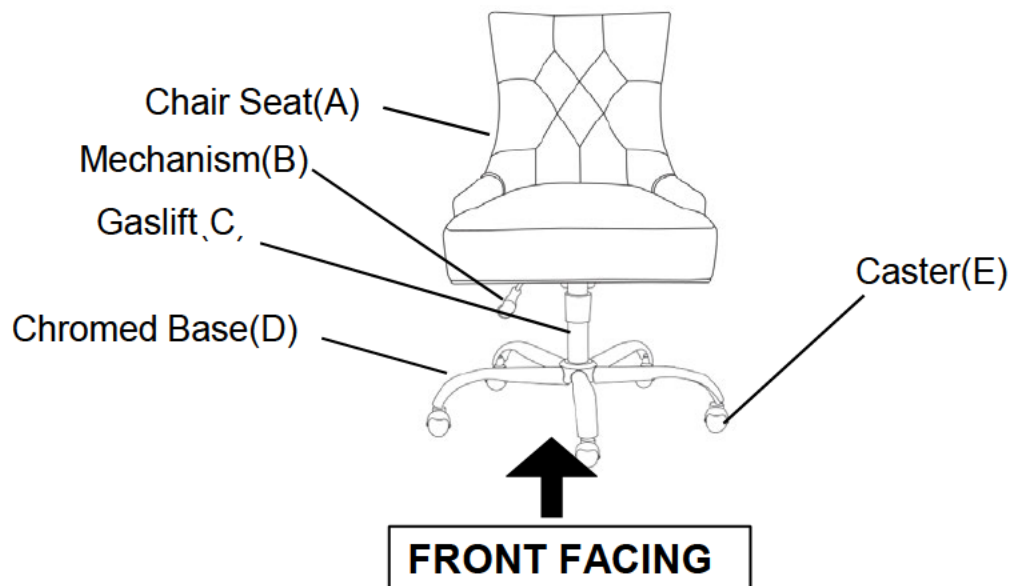

This Office Chair has multiple parts and may require up to 30 minutes to assemble. To give you an overview of the Office Chair parts, the above picture is to help you put the various parts into perspective. Please read through the instructions below to familiarise yourself with the parts and steps before assembly.

Step 1

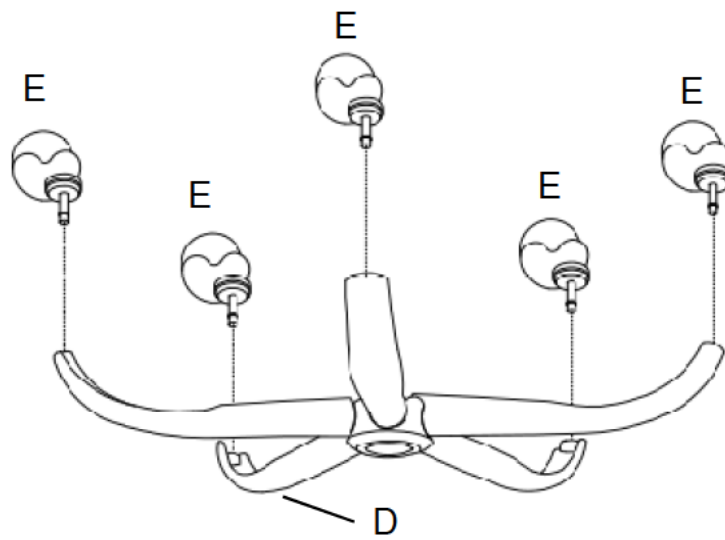

Unpack and place all parts on a clean, non-marring surface.
Place the Chrome Base(D) facedown as pictured.
Insert the Casters(E) into the mounting position of Chrome Base(D) as shown above.

Step 2

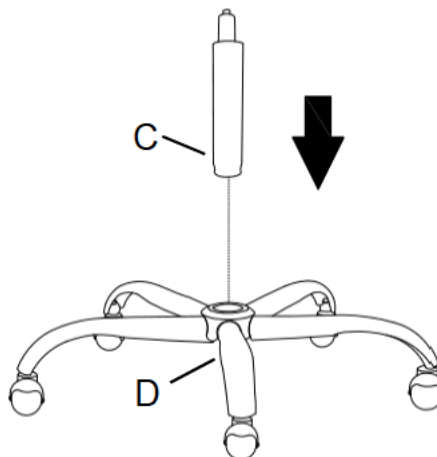

Insert the Gaslift(C) into the mounting position under of Chrome base(D) as pictured.

Note: The Gaslift(C) will self-lock into place.

Step 3

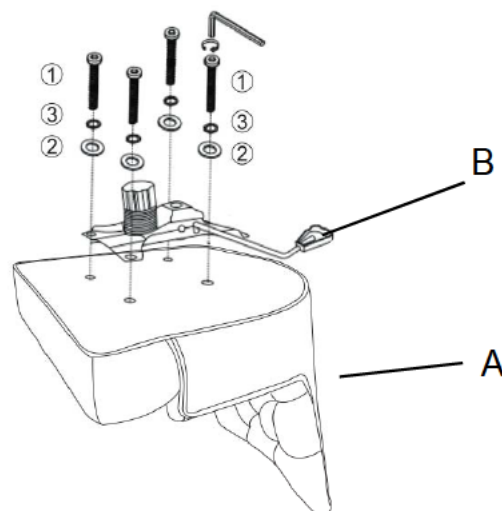

Attach Mechanism(B) to Chair Seat(A) using Bolts(①), Washers(②), and Spring Washers(③) with Allen Key(④).

Fully tighten the Bolts in a sequential manner.

Step 4

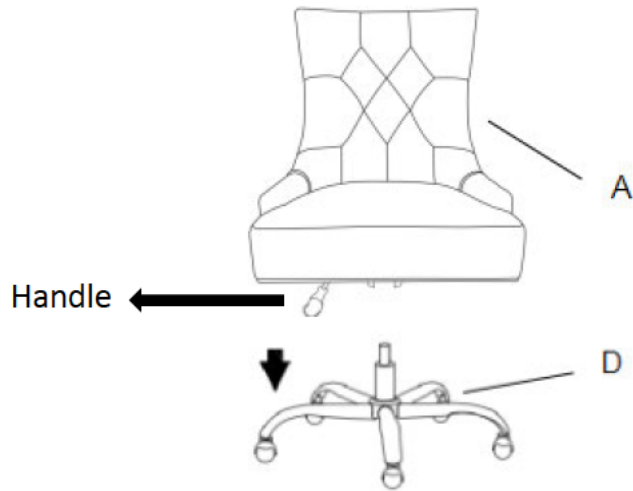

Turn the Chair Seat(A) up.

Insert the Chair Seat, A, into Chrome Base, D, as pictured.

Make sure all parts are connected and securely locked into position.

You can use the Mechanism's(B) handle to rise or lower the Chair.

Caution: You can use the Mechanism's handle (B) to control the office chair's wobble function



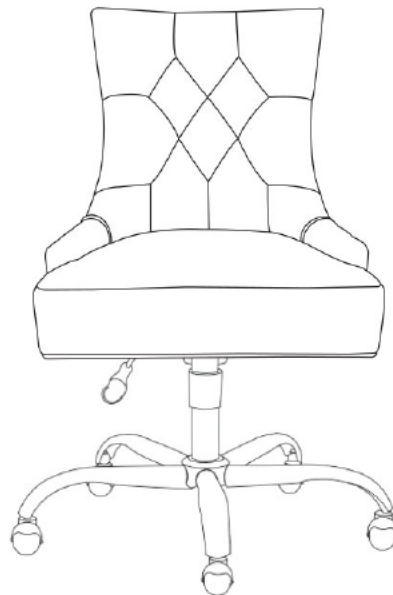











Step 5



Your Office Chair is ready for use.

This Office Chair can only be used on a flat, level surface.

Care & Maintenance

-   ● Do not put hot items directly on furniture surface
 -   ● Do not clean furniture with harsh cleansers or polish.
 -   ● Do not place furniture under direct sunlight.
 -   ● Do not place furniture near heating or cooling vents.
 -   ● Do not write on furniture without a padded barrier to protect the surface.
 -   ● Do not place furniture outside . For indoor use only .
 -   ● Not for commercial use. For residential use only .
 -   ● Stains may be removed with mild soap solution and damp cloth.
 -   ● Children should not climb or jump on the furniture.
-
-   ● Dust and pick-up spills using a clean, non-colored, lint-free cloth .