







# ASSEMBLY INSTRUCTIONS

ITEM NO :  
NIGHTSTAND

## BOX OF NIGHTSTAND NIGHTSTAND

ITEM	DRAWING	DESCRIPTION	QTY
A		NIGHTSTAND	1
B		LEG (Packed underneath bottom panel )	4

## BOX OF NIGHTSTAND HARDWARE LIST

ITEM	DRAWING	DESCRIPTION	QTY
1		JCB SCREW (M6 x 50mm)	8
2		SPRING WASHER (M6)	8
3		FLAT WASHER (1/4)	8
4		ALLEN KEY (M4)	1

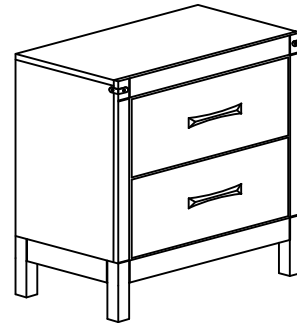

**COMPLETED NIGHTSTAND ASSEMBLY**

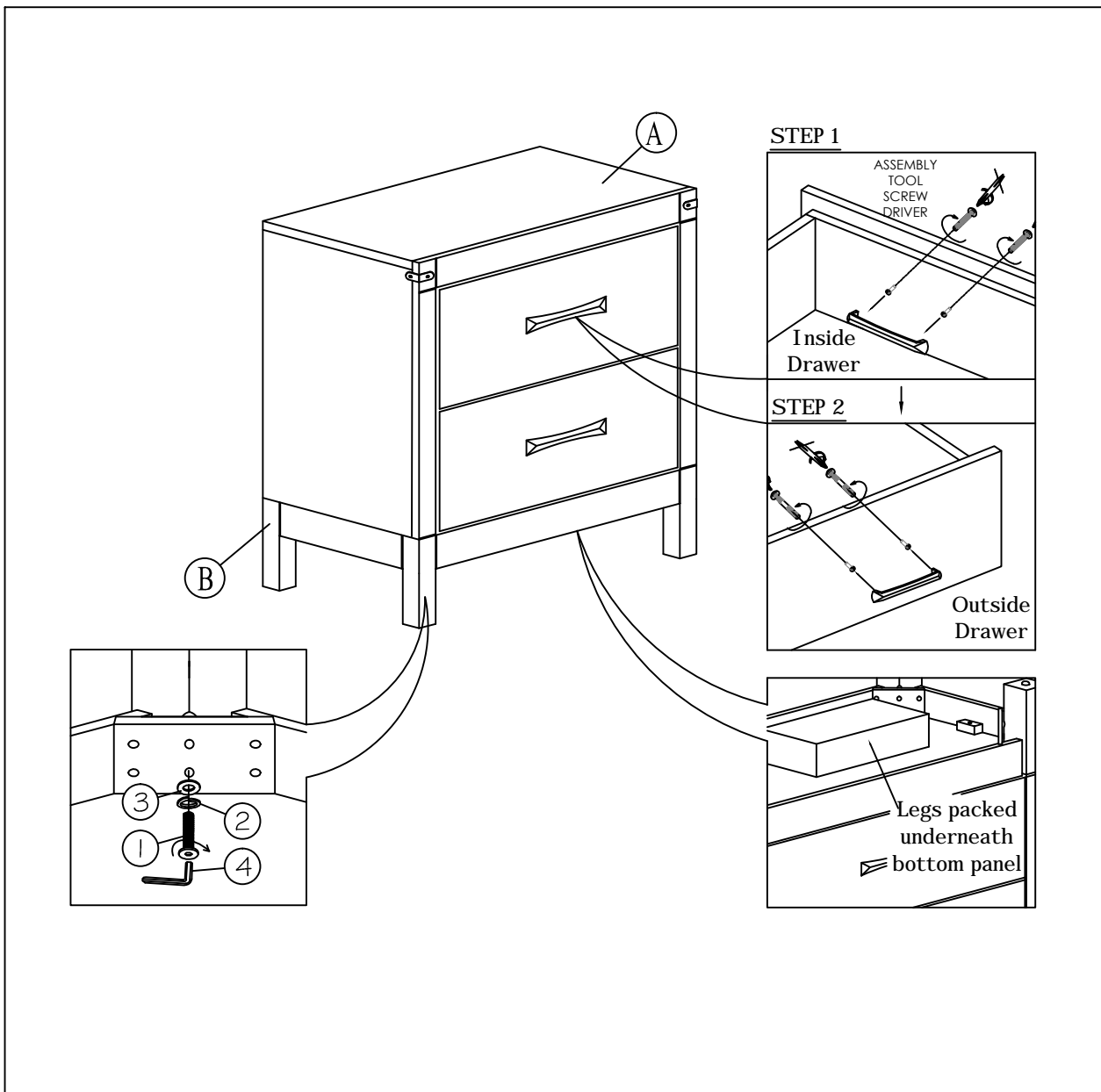

### THE HARDWARE IS LOCATED IN THE PACKING ITEMS

NOTE : MUST TIGHTEN SCREWS PERIODICALLY. WITH USE SCREWS MAY BECOME LOOSE.  
CHECK TIGHTNESS OF ALL SCREWS EVERY 6-8 WEEKS.

### CLEANING INSTRUCTION

After assembled, clean & polish the completed parts if necessary with soft cloth and industrial recognized furniture polish

**MADE IN MALAYSIA**