

Installationsanleitung
Installation Instruction
Instruction d'installation
Istruzioni di installazione

Instrucciones de instalación
Installatie-instructies
Installationsanvisningar
Instrukcje instalacji

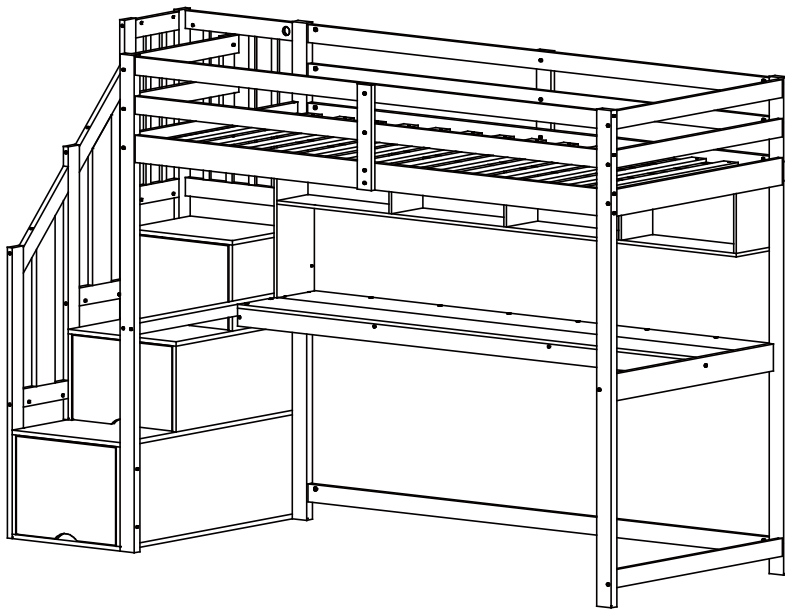
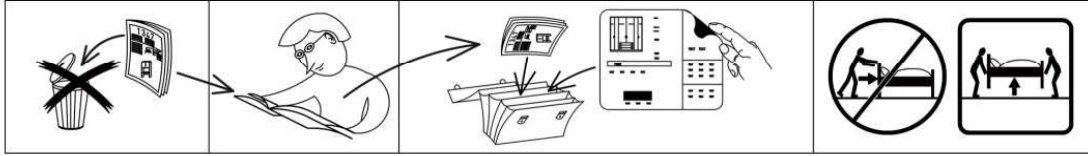

Kinderbett (90x190 cm)

SKU: N606P345836
N606P345837
N606P345838

DE: Unser Produkt wird Ihnen in 3 Paketen geliefert. Die Lieferzeiten dieser 3 Pakete können abweichen, bitte haben Sie etwas Geduld und vielen Dank für Ihr Verständnis.

UK: Our product will be delivered to you in 3 packages. The delivery times of these 3 packages may differ, please be patient and thank you for your understanding.

FR: Notre produit vous sera livré en 3 colis. Les délais de livraison de ces 3 colis peuvent différer, soyez patient et merci pour votre compréhension.

IT: Il nostro prodotto verrà consegnato in 3 pacchi. I tempi di consegna di questi 3 pacchi possono variare; vi preghiamo di avere un po' di pazienza e vi ringraziamo per la vostra comprensione.

ES: Nuestro producto se entregará en 3 paquetes. Los tiempos de entrega de estos 3 paquetes pueden variar; por favor, tenga un poco de paciencia y gracias por su comprensión.

NL: Ons product wordt in 3 pakketten bij u geleverd. De levertijden van deze 3 pakketten kunnen verschillen, we vragen om uw geduld en bedanken u voor uw begrip.

SE: Vår produkt kommer att levereras till dig i 3 paket. Leveranstiderna för dessa 3 paket kan variera, vi ber om ditt tålamod och tackar för din förståelse.

PL: Nasz produkt zostanie dostarczony w 3 paczkach. Czas dostawy tych 3 paczek może się różnić, prosimy o cierpliwość i dziękujemy za zrozumienie.

INSTRUCTIONS

IMPORTANT-READ CAREFULLY-RETAIN FOR FUTURE REFERENCE

- a) **WARNING** -Children can become trapped between the bed and the wall, the adjoining pieces of furniture (e.g. cupboards) and the lke. To avoid risk of serious injury the distance between the safety barrier and the adjoining structure shall not exceed 75 mm or shall be more than 230 mm.
- b) **WARNING** -Do not use the bed if any structural part is broken or missing; Replacement parts are between requested from the manufacturer or the store.
- c) **WARNING** -Do not climb or wiggle on any non-designated structures.
- d) It is imperative to always follow the installation instructions and manufacturer's use.
- e) **The recommended size of the mattress to be used with the bed is 190cmx90cm, maximum thickness mattress:12cm.**
- f) It is necessary to ventilate the room in order to maintain a low level moisture and prevent mold growth in the bed and its periphery.
- g) Joining devices should always be tightened properly and regularly verified. Tighten if necessary.
- h) **WARNING** -"Always ensure the platform and the ladder / stairs are permanently attached to this bunkbed before use".
- i) **WARNING** -"This product must be attached to a wall or building structure".
- j) Meets European standard requirements NC safety EN 747-1: 2024 &EN 747-2:2024.

ANLEITUNGEN

WICHTIG - SORGFÄLTIG LESEN - FÜR SPÄTERE VERWENDUNG

AUFBEWAHREN

- a) **WARNUNG** -- Kinder können zwischen dem Bett und der Wand, den angrenzenden Möbelstücken (z. B. Schränken) und der Lücke eingeklemmt werden. Um die Gefahr schwerer Verletzungen zu vermeiden, darf der Abstand zwischen der Sicherheitsbarriere und der angrenzenden Struktur nicht mehr als 75 mm oder mehr als 230 mm betragen.
- b) **WARNUNG** -Das Bett darf nicht benutzt werden, wenn ein Bauteil gebrochen ist oder fehlt; Ersatzteile sind beim Hersteller oder im Geschäft anzufordern.
- c) **WARNUNG**-Klettern oder wackeln Sie nicht auf nicht dafür vorgesehenen Strukturen.
- d) Befolgen Sie unbedingt die Installationsanweisungen und die Gebrauchsanweisungen des Herstellers.
- e) **Die empfohlene Größe der Matratze für das Bett beträgt 190x90cm, maximale Dicke der Matratze: 12cm.**
- f) Es ist notwendig, den Raum zu lüften, um die Feuchtigkeit niedrig zu halten und Schimmelbildung im Bett und seiner Umgebung zu verhindern.
- g) Die Verbindungselemente sollten immer richtig angezogen sein und regelmäßig überprüft werden. Ziehen Sie sie gegebenenfalls nach.
- h) **WARNUNG** -sorgt dafür, dass die stufen mit der leiter/treppe dauerhaft mit diesem bereich verbunden sind "Gehen sie schlafen, bevor sie benutzen."
- i) **WARNUNG** -das produkt muss an eine wand Oder eine architektonische struktur angeschlossen sein.
- j) Meets European standard requirements NC safety EN 747-1: 2024 &EN 747-2:2024.

ANLEITUNG

WICHTIG - SORGFÄLTIG DURCHLESEN – FÜR ZUKÜNFTIGE REFERENZ BEWAHREN

a) **WARNUNG** - Hochbetten und das Oberbett von Etagenbetten sind wegen der Verletzungsgefahr durch Stürze nicht für Kinder unter sechs Jahren geeignet.

b) **WARNUNG** - Etagenbetten und Hochbetten können ein ernstes Verletzungsrisiko darstellen, wenn sie nicht ordnungsgemäß verwendet werden. Befestigen oder hängen Sie niemals Gegenstände an einem Teil des Etagenbetts, die nicht für die Verwendung mit dem Bett vorgesehen sind, zum Beispiel Schnüre, Kordeln, Haken, Gurte und Taschen.

c) **WARNUNG** - Kinder können zwischen Bett und Wand eingeklemmt werden. Um die Gefahr schwerer Verletzungen zu vermeiden, darf der Abstand zwischen der oberen Sicherheitsbarriere und der angrenzenden Konstruktion 75 mm nicht überschreiten oder mehr als 230 mm betragen.

d) **WARNUNG** - Verwenden Sie das Etagenbett / Hochbett nicht, wenn ein Bauteil beschädigt ist oder fehlt. Ersatzteile werden zwischendurch beim Hersteller oder beim Händler angefordert.

e) Befolgen Sie unbedingt die Installationsanweisungen und die Gebrauchsanweisung des Herstellers.

f) Die empfohlene Größe der Matratze für das Bett beträgt **190 cm x 90 cm**, maximale Dicke der Matratze: **12 cm**.

g) Es ist notwendig, den Raum zu lüften, um ein niedriges Feuchtigkeitsniveau aufrechtzuerhalten und das Wachstum von Schimmel im Bett und an dessen Peripherie zu verhindern.

h) Verbindungselemente sollten immer richtig angezogen und regelmäßig überprüft werden. Bei Bedarf festziehen.

I) **WARNUNG**: sorgt dafür, dass die stufen mit der leiter/treppe dauerhaft mit diesem bereich verbunden sind "Gehen sie schlafen, bevor sie benutzen."

J) **WARNUNG**: das produkt muss an eine wand Oder eine architektonische struktur angeschlossen sein.

K) Erfüllt die Anforderungen der europäischen Norm NC-Sicherheit **EN 747-1: 2024 &EN 747-2:2024**.

INSTRUCTIONS

IMPORTANT - READ CAREFULLY - RETAIN FOR FUTURE REFERENCE

a) **WARNING** - High beds and the upper bed of bunk beds are not suitable for children under six years due to the risk of injury from falls;

b) **WARNING** - Bunk beds and high beds can present a serious risk of injury from strangulation if not used correctly. Never attach or hang items to any part of the bunk bed that are not designed to be used with the bed, for example, but not limited to ropes, strings, cords, hooks, belts and bags.

c) **WARNING** - Children can become trapped between the bed and the wall, a roof pitch, the ceiling adjoining pieces of furniture (e.g. cupboards) and the like. To avoid risk of serious injury the distance between the top safety barrier and the adjoining structure shall not exceed 75 mm or shall be more than 230 mm.

d) **WARNING** - Do not use the bunk bed/high bed if any structural part is broken or missing; Replacement parts are between requested from the manufacturer or the store.

e) it is imperative to always follow the installation instructions and manufacturer's use.

f) The recommended size of the mattress to be used with the bed is **190 cm x90cm**, maximum thickness mattress:**12cm**.

g) It is necessary to ventilate the room in order to maintain a low level moisture and prevent mold growth in the bed and its periphery.

h) Joining devices should always be tightened properly and regularly verified. Tighten if necessary.

i) **WARNING** - "Always ensure the platform and the ladder / stairs are permanently attached to this bunkbed before use"

j) **WARNING** - "This product must be attached to a wall or building structure"

k) Meets European standard requirements NC safety **EN 747-1: 2024 &EN 747-2:2024**

ISTRUZIONI

IMPORTANT - À LIRE ATTENTIVEMENT - CONSERVER POUR RÉFÉRENCE ULTÉRIEURE

a) **AVERTISSEMENT** - Les lits surélevés et le lit supérieur des lits superposés ne conviennent pas aux enfants de moins de six ans en raison du risque de blessure dû à une chute;

b) **AVERTISSEMENT** - Les lits superposés et les lits surélevés peuvent présenter un risque sérieux de blessure par strangulation s'ils ne sont pas utilisés correctement. Ne jamais attacher ou suspendre à des parties du lit superposé des objets qui ne sont pas conçus pour être utilisés avec le lit, par exemple, mais ne se limitant pas à des cordes, des ficelles, des cordes, des crochets, des ceintures et des sacs.

c) **AVERTISSEMENT** - Les enfants peuvent rester coincés entre le lit et le mur, un toit incline les meubles adjacents au plafond (par exemple, des armoires), etc. Pour éviter tout risque de blessure grave, la distance entre la barrière de sécurité supérieure et la structure adjacente ne doit pas dépasser 75 mm ou doit être supérieure à 230 mm.

d) **AVERTISSEMENT** - N'utilisez pas le lit superposé / le lit surélevé si une partie de la structure est cassée ou manquante. Les pièces de rechange sont demandées au fabricant ou au magasin.

e) il est impératif de toujours suivre les instructions d'installation et l'utilisation du fabricant.

f) La taille recommandée du matelas à utiliser avec le lit est **190 cm x 90 cm**, épaisseur maximale du matelas: **12 cm**.

g) Il est nécessaire de ventiler la pièce afin de maintenir un faible niveau d'humidité et d'empêcher la formation de moisissure dans le lit et à sa périphérie.

h) Les dispositifs de jonction doivent toujours être correctement serrés et vérifiés régulièrement. Serrer si nécessaire.

I) **AVERTISSEMENT**- assurez-vous toujours que la plate-forme et l'échelle/escalier sont fixés en permanence à cette couchette Lit avant utilisation"

J) **AVERTISSEMENT**- "ce produit doit être fixé à un mur ou à une structure de bâtiment"

K) Conforme aux exigences de la norme européenne en matière de sécurité NC **EN 747-1: 2024 &EN 747-2:2024** .

ISTRUZIONI

IMPORTANTE - LEGGERE ATTENTAMENTE - CONSERVARE IL FUTURO RIFERIMENTO

a) **ATTENZIONE** - I letti alti e il letto superiore a castello non sono adatti a bambini di età inferiore ai sei anni a causa del rischio di lesioni da cadute;

b) **AVVERTENZA** - I letti a castello e i letti alti possono presentare un serio rischio di lesioni a causa di strangolamento se non utilizzati correttamente. Non attaccare o appendere mai oggetti a qualsiasi parte del letto a castello che non sono progettati per essere utilizzati con il letto, ad esempio, ma non limitato a corde, corde, corde, ganci, cinture e borse.

c) **AVVERTENZA** - I bambini possono rimanere intrappolati tra il letto e la parete, un tetto inclinato il mobile adiacente al soffitto (ad es. armadi) e simili. Per evitare il rischio di gravi lesioni, la distanza tra la barriera di sicurezza superiore e a struttura adiacente non deve superare 75 mm o deve essere superiore a 230 mm.

d) **ATTENZIONE** - Non utilizzare il letto a castello / letto alto se qualche parte strutturale è rotta o mancante; Le parti di ricambio sono tra quelle richieste al produttore o al negozio.

e) è indispensabile seguire sempre le istruzioni di installazione e l'uso del produttore.

f) Le dimensioni consigliate del materasso da utilizzare con il letto sono **190 cm x 90 cm**, materasso di massimo spessore: **12 cm**.

g) È necessario ventilare l'ambiente per mantenere un'umidità bassa e prevenire la formazione di muffe nel letto e nella sua periferia.

h) I dispositivi di giunzione devono essere sempre serrati correttamente e regolarmente verificati. Stringere se necessario.

I) **ATTENZIONE**- "assicurarsi sempre che il marciapiede e la scala/scale siano fissati in modo permanente a questa cuccetta Letto prima dell' uso"

J) **ATTENZIONE**- "questo prodotto deve essere fissato a una parete o a una struttura di costruzione"

K) Soddisfa i requisiti della norma europea Sicurezza NC **EN 747-1: 2024 &EN 747-2:2024**

INSTRUCTIES

BELANGRIJK - LEES AANDACHTIG - BEWAAR VOOR

TOEKOMSTIGE REFERENTIE

- a) **WAARSCHUWING** - Hoge bedden en het bovenste bed van stapelbedden zijn niet geschikt voor kinderen jonger dan zes jaar vanwege het risico op letsel door vallen;
- b) **WAARSCHUWING** - Stapelbedden en hoge bedden kunnen een ernstig risico op verwonding vormen als ze niet correct worden gebruikt. Bevestig of hang nooit items aan een deel van het stapelbed die niet zijn ontworpen voor gebruik met het bed, bijvoorbeeld, maar niet beperkt tot touwen, koorden, koorden, haken, riemen en tassen.
- c) **WAARSCHUWING** - Kinderen kunnen vast komen te zitten tussen het bed en de muur, een dakhelling het plafond aangrenzende meubels (bijv. kasten) en dergelijke. Om het risico van ernstig letsel te voorkomen, mag de afstand tussen de bovenste veiligheidsbarrière en de aangrenzende structuur niet groter zijn dan 75 mm of meer dan 230 mm.
- d) **WAARSCHUWING** - Gebruik het stapelbed / hoogbed niet als een structureel onderdeel kapot is of ontbreekt; Vervangende onderdelen worden tussen gevraagd door de fabrikant of de winkel.
- e) het is noodzakelijk om altijd de installatie-instructies en het gebruik van de fabrikant te volgen.
- f) De aanbevolen maat van de matras die met het bed wordt gebruikt, is **190 cm x 90 cm, maximale dikte matras: 12 cm**.
- g) Het is noodzakelijk om de kamer te ventileren om een laag vochtgehalte te handhaven en schimmelgroei in het bed en de periferie ervan te voorkomen.
- h) Verbindingsinrichtingen moeten altijd goed worden vastgedraaid en regelmatig worden gecontroleerd. Draai indien nodig vast.
- i) **WAARSCHUWING - zorg ervoor dat het platform en de ladder/trap permanent verbonden zijn met deze kooi**
Slapen voor gebruik"
- j) **WAARSCHUWING - dit product moet worden bevestigd aan muren of gebouwen.**
- k) **Voldoet aan Europese standaardvereisten NC-veiligheid EN 747-1: 2024 & EN 747-2:2024.**

IINSTRUKCJE

WAŽNE - PRZECZYTAJ UWAGNIE - ZACHOWAJ NA

PRZYSZŁOŚĆ

- a) **OSTRZEŻENIE** - Wysokie łózka i górne łózko łózek piętrowych nie są odpowiednie dla dzieci poniżej sześciu lat ze względu na ryzyko obrażeń w wyniku upadku;
- b) **OSTRZEŻENIE** - Łózka piętrowe i wysokie łózka mogą stwarzać poważne ryzyko obrażeń na skutek uduszenia, jeśli nie zostaną właściwie użyte. Nigdy nie mocuj ani nie wieszaj przedmiotów na żadnej części łózka piętrowego, które nie są przeznaczone do użytku z łóżkiem, na przykład, ale nie ograniczając się do lin, sznurków, sznurków, haczyków, pasów i toreb.
- c) **OSTRZEŻENIE** - Dzieci mogą zostać uwięzione między łóżkiem a ścianą, nachyleniem dachu pod sufitem przylegającymi meblami (np. szafkami) i tym podobne. Aby uniknąć ryzyka poważnych obrażeń, odległość między górną barierą bezpieczeństwa a przylegającą konstrukcją nie może przekraczać 75 mm lub być większa niż 230 mm.
- d) **OSTRZEŻENIE** - Nie używaj łózka piętrowego / wysokiego łózka, jeśli jakkolwiek część konstrukcyjna jest zepsuta lub brakuje jej; Części zamienne są wymagane od producenta lub sklepu.
- e) bezwzględnie należy przestrzegać instrukcji instalacji i użytkowania producenta.
- f) Zalecany rozmiar materaca do zastosowania z łóżkiem to **190 cm x 90 cm**, maksymalna grubość materaca: **12 cm**.
- g) Konieczna jest wentylacja pomieszczenia w celu utrzymania niskiego poziomu wilgoci i zapobiegania rozwojowi pleśni w łózku i jego obrzeżach.
- h) Urządzenia łączące powinny być zawsze odpowiednio dokręcone i regularnie sprawdzane. Dokręć w razie potrzeby.
- i) **OSTRZEŻENIE "Zawsze upewnij się, że platforma i drabina / schody są na stałe przymocowane do tego leżanki łózko przed użyciem"**
- j) **OSTRZEŻENIE "Ten produkt musi być przymocowany do ściany lub konstrukcji budynku"**
- k) **Spełnia wymagania norm europejskich Bezpieczeństwo NC EN 747-1: 2024 & EN 747-2:2024.**

INSTRUKCE

DŮLEŽITÉ - PŘEČTĚTE SI POZORNĚ - UCHOVÁVAJTE

PRO BUDOUCÍ REFERENCE

- a) **VAROVÁNÍ** - vysoké postele a horní lůžka palandy nejsou vhodné pro děti do šesti let z důvodu rizika zranění pádem;
- b) **VAROVÁNÍ** - Patrové postele a vysoké postele mohou představovat vážné riziko zranění při uškrcení, pokud nebudou správně použity. Nikdy nepřipevňujte ani nezavěšujte předměty na žádnou část palandy, které nejsou navrženy pro použití s postelí, ale neomezují se pouze na lana, provázky, šňůry, háčky, pásy a tašky.
- c) **VÝSTRAHA** - Děti se mohou zachytit mezi postel a zeď, sklonit střechu stropy přilehlé kusy nábytku (např. skříně) a podobně. Aby se zabránilo riziku vážného zranění, nesmí vzdálenost mezi horní bezpečnostní bariérou a sousední konstrukcí překročit 75 mm nebo být větší než 230 mm.
- d) **VÝSTRAHA** - Nepoužívejte patrové lůžko / vysoké lůžko, pokud je některá konstrukční část zlomená nebo chybi; Náhradní díly jsou mezi na vyžádání od výrobce nebo obchodu.
- e) je bezpodmínečně nutné dodržovat instalační pokyny a použití výrobcem.
- f) Doporučená velikost matrace pro použití s postelí je **190 cm x 90 cm**, maximální tloušťka matrace: **12 cm**.
- g) Místnost je nutné ventilovat, aby se udržela nízká hladina vlhkosti a zabránilo se růstu plísní v loži a jeho obvodu.
- h) Spojovací zařízení by měla být vždy pevně dotažena a pravidelně ověřována. V případě potřeby dotáhněte.
- i) **VAROVÁNÍ- "Vždy se ujistěte, že plosina a Zebíik / schody jsou trvale připevněny k této palandě před použitím ulozte"**
- j) **VAROVÁNÍ- "Tento výrobek musí být připevněn ke zdi nebo stavební konstrukci"**
- k) **Spĺňuje požadavky evropské normy NC bezpečnost EN 747-1: 2024 & EN 747-2:2024.**

INŠTRUKCIE

DŌLEŽITÉ - POZORNE SI PREČÍTAJTE -

UCHOVÁVAJTE PRE BUDÚCE REFERENCIE

- a) **VÝSTRAHA** - Vysoké postele a horné postele poschodových postelí nie sú vhodné pre deti do šiestich rokov kvôli riziku zranenia pádom;
- b) **VÝSTRAHA** - poschodové postele a vysoké postele môžu predstavovať vážne riziko zranenia priškrtením, ak sa nebudú správne používať. Nikdy nepřipevňujte ani nevesajte predmety k žiadnej časti poschodovej postele, ktorá nie je určená na použitie s postelou, napríklad, ale nielen, lana, šnúry, šnúry, háčiky, pásy a tašky.
- c) **VÝSTRAHA** - Deti sa môžu zachytiť medzi postelou a stenou, sklonom strechy, stropom priliehajúcim kusy nábytku (napr. skrinky) a podobne. Aby sa predišlo riziku vážneho zranenia, vzdialenosť medzi hornou bezpečnostnou bariérou a príľahlou konštrukciou nesmie prekročiť 75 mm alebo byť viac ako 230 mm.
- d) **VÝSTRAHA** - Nepoužívajte poschodovú postel' / vysoké lóžko, ak je akákoľvek konštrukčná časť poškodená alebo chýba; Náhradné diely sú potrebné na vyžiadanie od výrobcu alebo skladu.
- e) je bezpodmínečne nutné postupovať podľa pokynov na inštaláciu a podľa pokynov výrobcu.
- f) Odporúčaná veľkosť matrace použitého na lóžko je **190 cm x 90 cm**, maximálna hrúbka matrace: **12 cm**.
- g) Miestnosť je potrebné vetrať, aby sa udržala nízka úroveň vlhkosti a zabránilo sa rastu plesní v lóžku a jeho obvode.
- h) Spojovacie zariadenia by sa mali vždy pevne dotiahnuť a pravidelne preverovať. V prípade potreby dotiahnite.
- i) **VÝSTRAHA - "Vždy sa uistite, že plosina a rebrik/schody sÁ trvalo připevnené k tomuto lóžku**
IÁžko pred použitím"
- j) **VÝSTRAHA - "Tento výrobok musí byť připevněný k stene alebo stavebnej konštrukcii"**
- k) **Spĺňa požiadavky európskych noriem NC bezpečnosť EN 747-1: 2024 & EN 747-2:2024.**

UTASÍTÁS

FONTOS - OLVASSA EL FIGYELMESEN - VÁRJON A JÖVŐBEN

- a) **VIGYÁZAT** - A magas ágyak és az emeletes ágyak felső ágya nem alkalmas hat év alatti gyermekek számára az esések sérülésének veszélye miatt;
- b) **FIGYELMEZTETÉS** - Az emeletes ágyak és a magas ágyak súlyos sérülést okozhatnak a fojtogatás következtében, ha nem használják helyesen. Soha ne csatlakoztasson és ne lógjon az emeletes ágy olyan részeire, amelyek például nem az ágyhoz való felhasználásra terveztek, de ezekre nem korlátozódnak: kötelek, hurok, zsinórok, horgok, övek és táskák.
- c) **FIGYELMEZTETÉS** - A gyermekek becsapódhatnak az ágy és a fal közé, tetőtéri a mennyezetet a szomszédos bútorokhoz (például szekrényekhez) és hasonlókat. A súlyos sérülés kockázatának elkerülése érdekében a felső biztonsági akadály és a szomszédos szerkezet közötti távolság nem haladhatja meg a 75 mm-t vagy több, mint 230 mm.
- d) **FIGYELMEZTETÉS** - Ne használja az emeletes ágyat / magas ágyat, ha valamelyik szerkezeti elem törött vagy hiányzik; A cserealkatrészeket a gyártótól vagy a bolttól kérheti.
- e) feltétlenül kövesse a telepítési utasításokat és a gyártó általi felhasználást.
- f) Az ágyhoz használni kívánt matrac ajánlott mérete **190 cm x 90 cm, a matrac maximális vastagsága: 12 cm.**
- g) Szellőztetni kell a helyiséget, hogy fennmaradjon az alacsony nedvességtartalom, és megakadályozzák a penész növekedését az ágyban és annak peremén.
- h) A csatlakozóberendezéseket mindig megfelelően meg kell húzni és rendszeresen ellenőrizni kell. Szükség esetén húzza meg.
- i) **FIGYELMEZTETÉS** - "Mindig győződjön meg arról, hogy a platform és a létra / lépcső Állandóan ehhez az Ágyhoz van rögzítve Ágy használattal előtt"
- j) "Ezt a terméket falhoz vagy épületszerkezethez kell rögzíteni"
- k) Megfelel az európai szabvány követelményeinek NC biztonsági **EN 747-1: 2024 & EN 747-2:2024**.

INSTRUCȚIUNI

IMPORTANT - CITIȚI CU ATENȚIE - PĂȚIȚI PENTRU REFERINȚĂ VIITORĂ

- a) **AVERTIZARE** - Paturile înalte și patul superior al paturilor nu sunt potrivite pentru copiii sub șase ani din cauza riscului de rănire din cauza căderilor;
- b) **AVERTIZARE** - Paturile suprapuse și paturile înalte pot prezenta un risc grav de rănire din cauza strangulării dacă nu sunt utilizate corect. Nu atașați și nu agățați niciodată articole pe nicio parte a patului care nu sunt concepute pentru a fi utilizate cu patul, de exemplu, dar fără a se limita la frânghii, corzi, șnururi, cârlige, curele și saci.
- c) **AVERTIZARE** - Copiii pot deveni prinși între pat și perete, pot acoperi acoperișul pe piesele de mobilier alăturate (de ex. dulapuri) și altele asemenea. Pentru a evita riscul de rănire gravă, distanța dintre bariera de siguranță superioară și structura alăturată nu trebuie să depășească 75 mm sau să fie mai mare de 230 mm.
- d) **AVERTIZARE** - Nu folosiți patul supraetajat / patul înalt dacă o parte structurală este ruptă sau lipsește; Piesele de schimb se fac între solicitarea producătorului sau a magazinului.
- e) este obligatoriu să respectați întotdeauna instrucțiunile de instalare și utilizarea producătorului.
- f) Dimensiunea recomandată a saltelei care va fi folosită cu patul este **de 190 cm x 90 cm, grosimea maximă a saltelei: 12 cm.**
- g) Este necesară ventilarea camerei pentru a menține o umiditate la nivel scăzut și a preveni creșterea mușcăiului în pat și la periferia acestuia.
- h) Dispozitivele de îmbinare trebuie întinse întotdeauna corect și verificate regulat. Strângeți dacă este necesar.
- i) **AVERTIZARE** - "Asigurați-vă întotdeauna că platforma și scara / scările sunt atasate permanent la acest pat înainte de utilizare"
- j) **AVERTIZARE** - "Acest produs trebuie atașat la un perete sau la o structură a clădirii"
- k) Îndeplinește cerințele standardelor europene privind siguranța NC **EN 747 -1: 2024 & EN 747-2:2024**.

TALÍMATLAR

ÖNEMLİ - DİKKATLE OKUYUN - GELECEK REFERANS İÇİN TUTUN

- a) **UYARI** - Yüksek yataklar ve ranzaların üst yatağı, düşme nedeniyle yaralanma tehlikesi nedeniyle altı yaşın altındaki çocuklar için uygun değildir;
- b) **UYARI** - Ranzalar ve yüksek yataklar, doğru kullanılmadığı takdirde boğulma nedeniyle ciddi yaralanma riski oluşturabilir. Hiçbir zaman ranza yatağının, yatakla birlikte kullanılmak üzere tasarlanmamış, ancak ipler, ipler, kordonlar, kancalar, kayışlar ve çantalar ile sınırlı olmamak üzere herhangi bir parçasına takmayın veya asılmayın.
- c) **UYARI** - Çocuklar yatakla duvar arasında sıkışıp kalabilir, tavana bitişik mobilya parçaları (örneğin dolaplar) ve benzeri bir tavan düşer. Ciddi yaralanma riskini önlemek için üst güvenlik bariyeri ve bitişik yapı arasındaki mesafe 75 mm'yi geçmemelidir veya 230 mm'den fazla olmalıdır.
- d) **UYARI** - Herhangi bir yapısal parça kırılmış veya eksikse ranza / yüksek yatak kullanmayın; Yedek parçalar üretici veya mağazadan talep arasındadır.
- e) her zaman kurulum talimatlarını ve üreticinin kullanımını takip etmek zorunludur.
- f) Yatak ile birlikte kullanılması tavsiye edilen **yatak boyutu 190 cm x 90 cm, maksimum kalınlık yatağı: 12 cm'dir.**
- g) Düşük seviyede nem sağlamak ve yatak ve çevresinde küf oluşumunu önlemek için odanın havalandırılması gerekir.
- h) Birleştirme cihazları her zaman uygun şekilde sıkılmalı ve düzenli olarak kontrol edilmelidir. Gerekirse sıkın.
- i) **UYARI** - "Her zaman platformun ve merdivenin / merdivenlerin bu ranzaya kalıcı olarak bağlı olduğundan emin olun kullanmadan önce yatak"
- j) **UYARI** - "Bu ürün bir duvara veya bina yapısına takılmalıdır"
- k) **EN 747-1: 2024 & EN 747-2:2024** Avrupa standardı gerekliliklerini karşılar.

ИНСТРУКЦИИ

ВАЖНО - ПРОЧИТАЙТЕ ВНИМАТЕЛЬНО - СОХРАНИТЕ БУДУЩУЮ ССЫЛКУ

- a) **ПРЕДУПРЕЖДЕНИЕ** - Высокие кровати и верхняя кровать двухъярусных кроватей не подходят для детей младше шести лет из-за риска получения травмы в результате падения;
- b) **ПРЕДУПРЕЖДЕНИЕ** - двухъярусные кровати и высокие кровати могут представлять серьезную опасность травмирования от удушья, если их неправильно использовать. Никогда не прикрепляйте и не подвешивайте предметы к какой-либо части двухъярусной кровати, например, которые не предназначены для использования с кроватью, но не ограничиваются веревками, веревками, шнурами, крючками, ремнями и сумками.
- c) **ПРЕДУПРЕЖДЕНИЕ** - Дети могут оказаться в ловушке между кроватью и стеной, крышей, наклонить потолок к смежным предметам мебели (например, шкафам) и т.п. Во избежание риска получения серьезных травм расстояние между верхним защитным барьером и прилегающей конструкцией не должно превышать 75 мм или должно быть более 230 мм.
- d) **ПРЕДУПРЕЖДЕНИЕ** - не используйте двухъярусную кровать / высокую кровать, если какая-либо конструктивная часть сломана или отсутствует; Запасные части между запросами от производителя или магазина.
- e) обязательно всегда следовать инструкциям по установке и использованию изготовителем.
- f) Рекомендуемый размер матраса, который будет использоваться с кроватью, составляет **190 см x 90 см, максимальная толщина матраса: 12 см.**
- g) Необходимо проветривать помещение, чтобы поддерживать низкий уровень влаги и предотвращать образование плесени в ложе и на его периферии.
- h) Соединительные устройства всегда должны быть надежно затянуты и регулярно проверяться. Затянуть при необходимости.
- i) **ПРЕДУПРЕЖДЕНИЕ** - "Всегда убедитесь, что платформа и лестница/лестница постоянно прикреплены к этой койке Кровать перед использованием"
- j) **ПРЕДУПРЕЖДЕНИЕ** - "Этот продукт должен быть прикреплен к стене или строительной конструкции"
- k) Соответствует требованиям Европейского стандарта NC Safety **EN 747-1: 2024 & EN 747-2:2024**

English

IMPORTANT ! KEEP FOR FUTURE REFERENCE : READ CAREFULLY

- To be assembled by an adult. Assembly must be checked by an adult before use
- WARNING ! Keep all screws, small parts and plastic bags out of the reach of children
- Properly identify all parts before assembling
- Never use your item if any of its parts are broken or missing
- Should any problems arise, please contact our After Sales Service
- Manufacturer's instructions shall be followed at all times
- Care: Clean with a soft, dry cloth. In case of larger stains, carefully rub with a slightly damp, non-abrasive sponge
- Avoid the risk of fire by not placing furniture near sources of ignition or hot items
- Do not jump on the bed

Deutsch

WICHTIG ! ZUM SPÄTEREN NACHSCHLAGEN AUFBEWAHREN: SORGFÄLTIG LESEN

- Muss von einem Erwachsenen zusammengebaut werden. Der Zusammenbau muss vor dem Gebrauch von einem Erwachsenen überprüft werden
- WARNUNG! Bewahren Sie alle Schrauben, Kleinteile und Plastikbeutel außerhalb der Reichweite von Kindern auf
- Kennzeichnen Sie vor dem Zusammenbau alle Teile richtig
- Benutzen Sie Ihren Artikel niemals, wenn Teile gebrochen sind oder fehlen
- Sollten Probleme auftreten, wenden Sie sich bitte an unseren Kundendienst
- Die Anweisungen des Herstellers sind stets zu befolgen
- Pflege: Mit einem weichen, trockenen Tuch reinigen. Bei größeren Flecken vorsichtig mit einem leicht feuchten, nicht scheuernden Schwamm abreiben. nicht scheuernden Schwamm
- Vermeiden Sie die Gefahr eines Brandes, indem Sie die Möbel nicht in der Nähe von Zündquellen oder heißen Gegenständen aufstellen
- Nicht auf das Bett springen

Français

IMPORTANT ! CONSERVER POUR RÉFÉRENCE ULTÉRIEURE : LIRE ATTENTIVEMENT

- Le montage doit être effectué par un adulte. Le montage doit être vérifié par un adulte avant Utilisation
- ATTENTION ! Tenir les vis, les petites pièces et les sachets en plastique hors de portée des enfants
- Identifiez correctement toutes les pièces avant de les assembler
- N'utilisez jamais votre article si l'une de ses pièces est cassée ou manquante
- En cas de problème, veuillez contacter notre service après-vente
- Les instructions du fabricant doivent être respectées à tout moment
- Entretien : nettoyer avec un chiffon doux et sec. En cas de taches plus importantes, frotter soigneusement avec une éponge non abrasive légèrement humide. légèrement humide et non Abrasive
- Évitez les risques d'incendie en ne plaçant pas les meubles à proximité de sources d'inflammation ou d'objets chauds
- Ne pas sauter sur le lit

Italiano

IMPORTANTE! CONSERVARE PER RIFERIMENTO FUTURO: LEGGERE ATTENTAMENTE

- Deve essere assemblato da un adulto. L'assemblaggio deve essere controllato da un adulto prima dell'uso
- **ATTENZIONE!** Tenere tutte le viti, le piccole parti e i sacchetti di plastica fuori dalla portata dei bambini
- Identificare correttamente tutte le parti prima dell'assemblaggio
- Non utilizzare mai l'articolo se alcune parti sono rotte o mancanti
- In caso di problemi, si prega di contattare il nostro Servizio Post Vendita
- Le istruzioni del produttore devono essere sempre seguite
- Cura: Pulire con un panno morbido e asciutto. In caso di macchie più estese, strofinare accuratamente con una spugna leggermente umida e non abrasiva
- Evitare il rischio di incendio, non collocando i mobili vicino a fonti di accensione o a oggetti caldi
- Non saltare sul letto

Español

¡ IMPORTANTE ! CONSERVELO PARA FUTURAS CONSULTAS: LEA ATENTAMENTE

- Debe ser montado por un adulto. El montaje debe ser comprobado por un adulto antes del uso
- ADVERTENCIA** Mantenga todos los tornillos, piezas pequeñas y bolsas de plástico fuera del alcance de los niños.
- Identifique correctamente todas las piezas antes de montarlas
 - Nunca utilice su artículo si alguna de sus piezas está rota o falta
 - Si surge algún problema, póngase en contacto con nuestro Servicio Postventa
 - Las instrucciones del fabricante deben seguirse en todo momento
 - Cuidado: Limpiar con un paño suave y seco. En caso de manchas más grandes, frote cuidadosamente con una esponja no abrasiva ligeramente humedecida.
 - Evite el riesgo de incendio no colocando los muebles cerca de fuentes de ignición u objetos calientes.
 - No saltar sobre la cama.

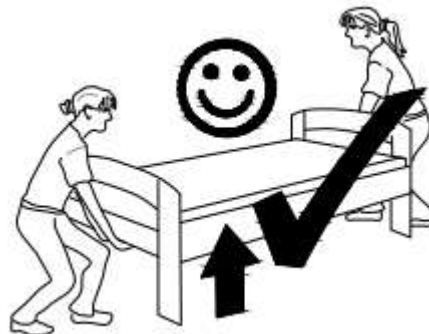

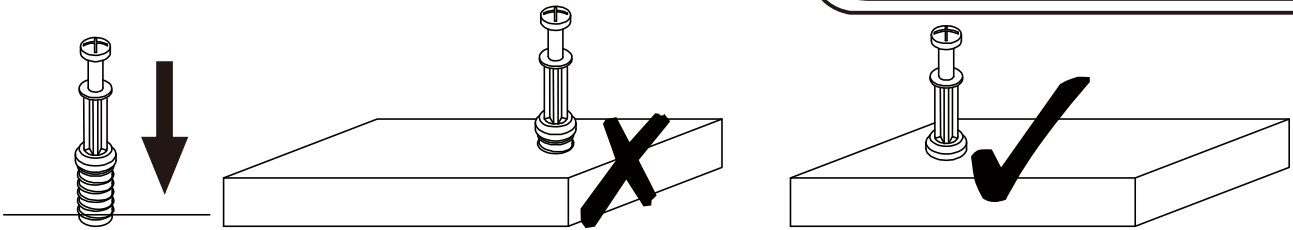

EN_QUICKFIT: Tighten quickfit until shoulder is flush with panel. Do not overtighten or undertighten.

FR_RACCORD RAPIDE: Faites serrer le raccord rapide jusqu'à ce que l'épaulement soit parfaitement encastré dans le panneau. Il ne faut ni trop serrer ni insuffisamment serrer.

ES_QUICKFIT: Apriete quickfit hasta que el hombro se descargue con el panel. NO lo sobreapriete ni lo apriete poco.

DE_QUICKFIT: Ziehen Sie den Quickfit fest, bis die Schulter mit der Platte bündig ist. Bitte nicht zu fest oder zu schwach anziehen.

IT_MONTAGGIO RAPIDO: Stringere il montaggio rapido fino a quando la spalla è a filo con il pannello, non stringere troppo o troppo poco.

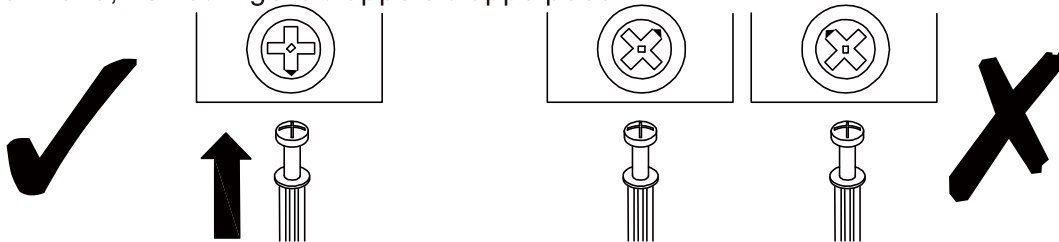

EN_CAM LOCK: When fitting cam lock, ensure starting position is correct before you insert connecting quickfit.

FR_SERRURE BATTEUSE: Avant d'insérer la serrure batteuse, veillez à la bonne orientation avant d'insérer le raccord rapide.

ES_CIERRE DE LA CÁMARA: Cuando instale el cierre de la cámara, asegúrese de que la posición de inicio es correcta antes de que inserte el quickfit conector.

DE_CAM-LOCK: Achten Sie bei der Montage des Cam-Locks auf die richtige Ausgangsposition, bevor Sie den Quickfit einsetzen.

IT_BLOCCAGGIO A CAMMA: Quando si monta il bloccaggio a camma, assicurarsi che la posizione iniziale sia corretta prima di inserire il montaggio rapido di collegamento.

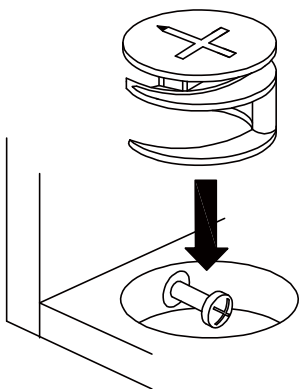

EN_Quickfit head should be in the centre of the cam lock when the two panels are joined.

Cam lock should be inserted before quickfit.

FR_Lorsque les deux panneaux sont assemblés, la tête du raccord rapide doit reposer au centre de la serrure batteuse. Il faut insérer la serrure batteuse avant le raccord rapide.

ES_El cabezal del quickfit debe estar en el centro del cierre de la cámara cuando se unan los dos paneles.

Se debe insertar el cierre de la cámara antes que el quickfit.

DE_Der Quickfit-Kopf sollte sich in der Mitte des Cam-Locks befinden, wenn die beiden Platten zusammengefügt sind.

Der Cam-Lock sollte vor dem Quickfit eingesetzt werden.

IT_La testa del montaggio rapido deve trovarsi al centro del bloccaggio a camma quando i due pannelli sono uniti.

Il Bloccaggio a Camma deve essere inserito prima del montaggio rapido.

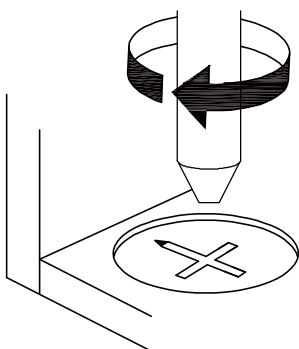

EN_Turn cam lock clockwise to tighten.

FR_Faites tourner la serrure batteuse dans le sens des aiguilles d'une montre pour la resserrer.

ES_Gire el cierre de la cámara en sentido horario para apretarlo.

DE_Drehen Sie den Cam-Lock im Uhrzeigersinn, um ihn festzuziehen.

IT_Ruotare il bloccaggio a camma in senso orario per stringere.

DE: Vor dem Einbau die Schrauben in die Löcher stecken und festziehen, aber nicht bis 100%, 70% bis 80% anziehen reicht aus. Schließlich, nachdem alle Schrauben installiert sind, ziehen Sie alle Schrauben auf 100%. Wenn Sie auf diese Probleme stoßen, wie z. B. Fehlausrichtung der Löcher oder Unfähigkeit, bestimmte Teile zu installieren, überprüfen Sie bitte, ob die Schrauben korrekt verwendet werden und passen Sie die Dichtigkeit der Schrauben an.

UK: Before installation, insert the screws into the holes and tighten them, but do not tighten them to 100%, 70% to 80% is sufficient. Finally, after all screws are installed, tighten all screws to 100%. If you encounter these issues, such as if the holes cannot be aligned or some parts cannot be installed, please check if the screws are used correctly and adjust the tightness of the screws.

FR: Insérer la vis dans le trou avant la fin de l'assemblage, serrer la vis, mais ne pas serrer à 100%, 70% ~ 80% est correct. Enfin, une fois que toutes les vis sont bien serrées, toutes les vis sont serrées à 100%. Si vous rencontrez ces problèmes, par exemple si les trous ne sont pas alignés ou si certaines pièces ne peuvent pas être montées, vérifiez que les vis sont utilisées correctement et Ajustez leur serrage.

IT: Prima dell'installazione, inserire le viti nei fori e stringerle, ma non al 100%, è sufficiente stringerle al 70% - 80%. Infine, dopo aver installato tutte le viti, stringere tutte le viti al 100%. Se riscontri problemi come disallineamenti dei fori o difficoltà nell'installare alcuni componenti, verifica che le viti siano utilizzate correttamente e regola la tensione delle viti.

ES: Antes de la instalación, coloque los tornillos en los agujeros y apriéte los, pero no al 100%; apretar al 70% - 80% es suficiente. Finalmente, después de haber instalado todos los tornillos, apriete todos los tornillos al 100%. Si se encuentra con problemas como desalineación de los agujeros o dificultad para instalar ciertas piezas, verifique que los tornillos se estén utilizando correctamente y ajuste la tensión de los tornillos.

NL: Voordat u begint met de installatie, plaatst u de schroeven in de gaten en draait u ze aan, maar draai ze niet volledig aan; 70% tot 80% is voldoende. Draai uiteindelijk, nadat alle schroeven zijn geplaatst, alle schroeven volledig aan. Als u problemen ondervindt, zoals niet uitgelijnde gaten of onderdelen die niet kunnen worden geïnstalleerd, controleer dan of de schroeven correct zijn gebruikt en pas de spanning van de schroeven aan.

SE: Innan installation, sätt i skruvarna i hålen och dra åt dem, men dra inte åt dem helt; 70% till 80% är tillräckligt. Slutligen, när alla skruvar är installerade, dra åt alla skruvar helt. Om du stöter på problem, som att hålen inte kan justeras eller vissa delar inte kan installeras, kontrollera om skruvarna används korrekt och justera skruvarnas åtdragning.

PL: Przed instalacją wstaw śruby w otwory i dokręć je, ale nie dokręcaj ich na 100%; 70% do 80% wystarczy. Na koniec, po zainstalowaniu wszystkich śrub, dokręć wszystkie śruby do 100%. Jeśli napotkasz problemy, takie jak niedopasowane otwory lub części, które nie mogą być zainstalowane, sprawdź, czy śruby są używane prawidłowo i dostosuj ich dokręcenie.

Importeur	COMHARBOR LIMITED
Add	Unit C, Swift Point, Cosford Lane, Rugby, CV21 1PY,GB
URL	harborcomhar@gmail.com
Hersteller	Sunmart Homeware co.,Limited
Adresse	No.127Building, No.702 ShanHe Road,Chengyang District,Qingdao,China
Email/URL	cherry@frdfurniture.com
	COMHARBOR LIMITED Unit C, Swift Point, Cosford Lane, Rugby, CV21 1PY,GB harborcomhar@gmail.com

💡 More Tips 💡

1

English - Before installation, you can place the parts on a carpet or other soft fabric, in order to avoid damaging your floor.

Français - Avant l'installation, vous pouvez placer les pièces sur un tapis ou un autre tissu doux, afin d'éviter d'endommager votre sol.

Deutsch - Vor der Installation können Sie die Teile auf einen Teppich oder ein anderes weiches Material legen, um eine Beschädigung Ihres Fußbodens zu vermeiden.

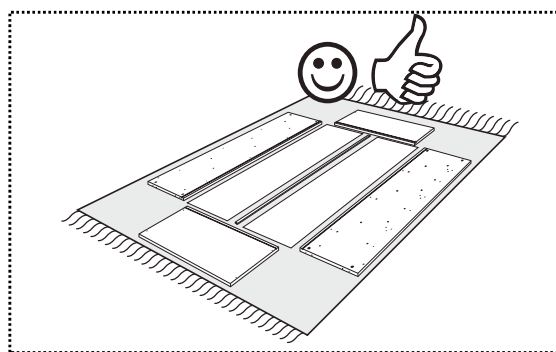
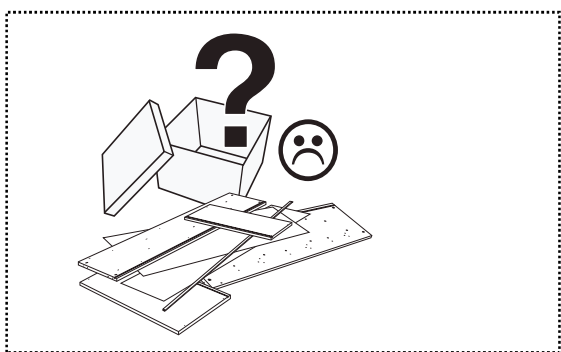

2

English - For your and your family's safety, please do not jump on beds, especially with hydraulic structures. When need to move bed, please work with more than one person to lift, not push, to avoid scratching your floor and hurting the stability of the bed.

Français - Pour votre sécurité et celle de votre famille, ne sautez pas sur les lits, en particulier sur les structures hydrauliques. Lorsqu'il est nécessaire de déplacer le lit, il est préférable de travailler à plusieurs pour le soulever, et non pour le pousser, afin d'éviter de rayer le sol et de nuire à la stabilité du lit.

Deutsch - Zu Ihrer Sicherheit und der Ihrer Familie sollten Sie nicht auf Betten springen, insbesondere bei hydraulischen Konstruktionen. Wenn Sie das Bett bewegen müssen, heben Sie es bitte mit mehreren Personen an und schieben Sie es nicht, um den Boden nicht zu verkratzen und die Stabilität des Bettes nicht zu beeinträchtigen.

Español - Para su seguridad y la de su familia, por favor no salte sobre las camas, especialmente con estructuras hidráulicas. Cuando tenga que mover la cama, por favor, trabaje con más de una persona para levantar, no empujar, para evitar rayar su piso y dañar la estabilidad de la cama.

Italia - Per la sicurezza vostra e della vostra famiglia, vi preghiamo di non saltare sui letti, soprattutto se dotati di strutture idrauliche. Quando è necessario spostare il letto, si prega di lavorare con più di una persona per sollevare, non spingere, per evitare di graffiare il pavimento e danneggiare la stabilità del letto.

Safety Advice

1) Please take the time to carefully read through the whole of these instructions before you commence.

2) Keep these instructions for future reference.

3) Unpack, inspect and check off all of the contents. Please dispose of all packaging safely.

Small component parts could choke a child if swallowed.

4) We strongly recommend that you keep children well away from the work area.

It would be sensible to lay a sheet or blanket on the floor where you intend to work to avoid scratching this product and to protect your floor.

5) This product is heavy. Take extreme care when lifting to avoid personal injury or damage to the product.

6) Assemble the product as close to its intended final position in the room as possible. Please check the contents of boxes before attempting to assemble this product.

Tools Required (Not Included)

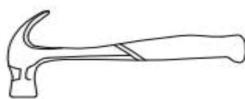

MONTAGEANLEITUNG/ASSEMBLY INSTRUCTIONS

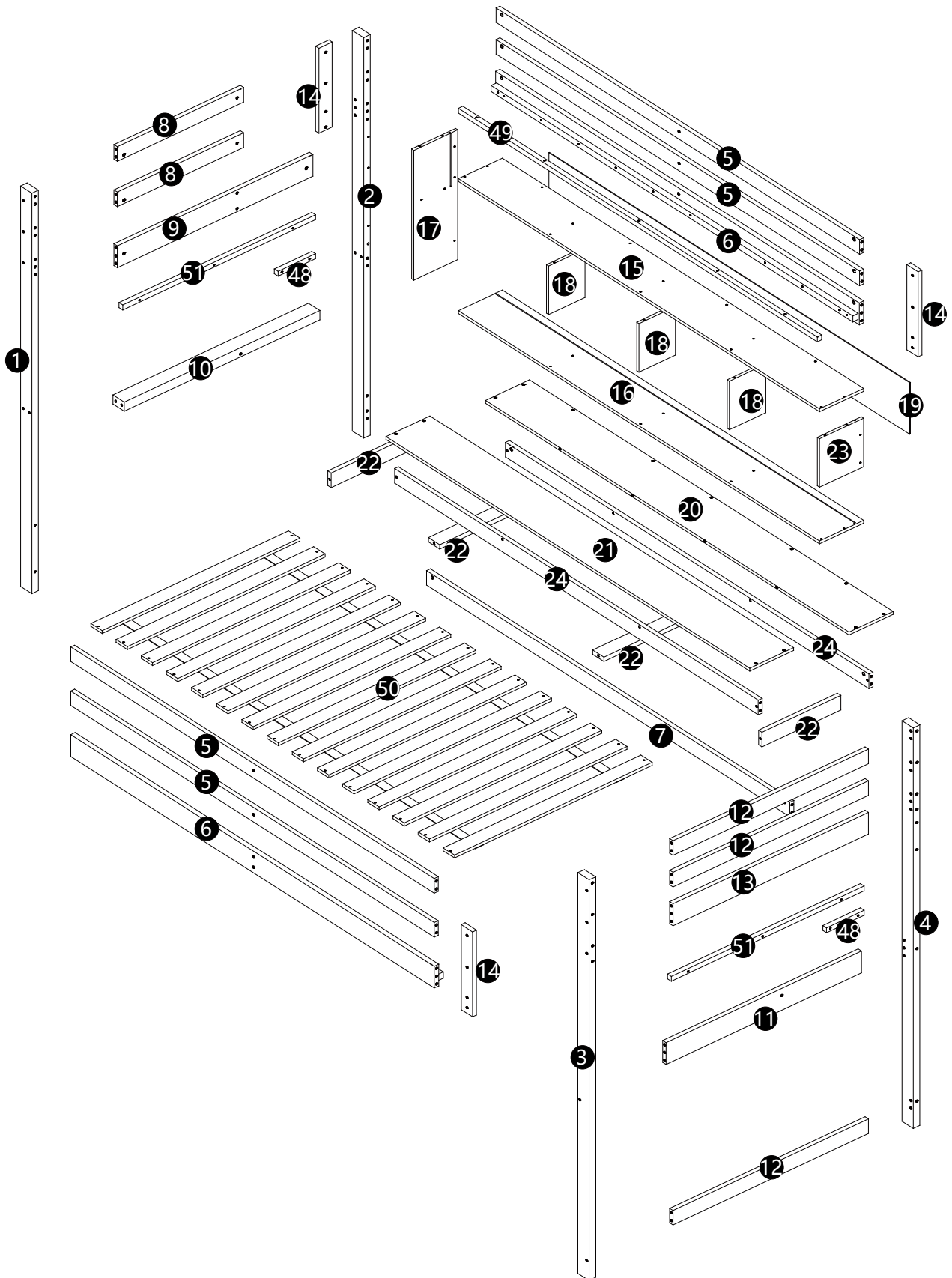

MONTAGEANLEITUNG/ASSEMBLY INSTRUCTIONS

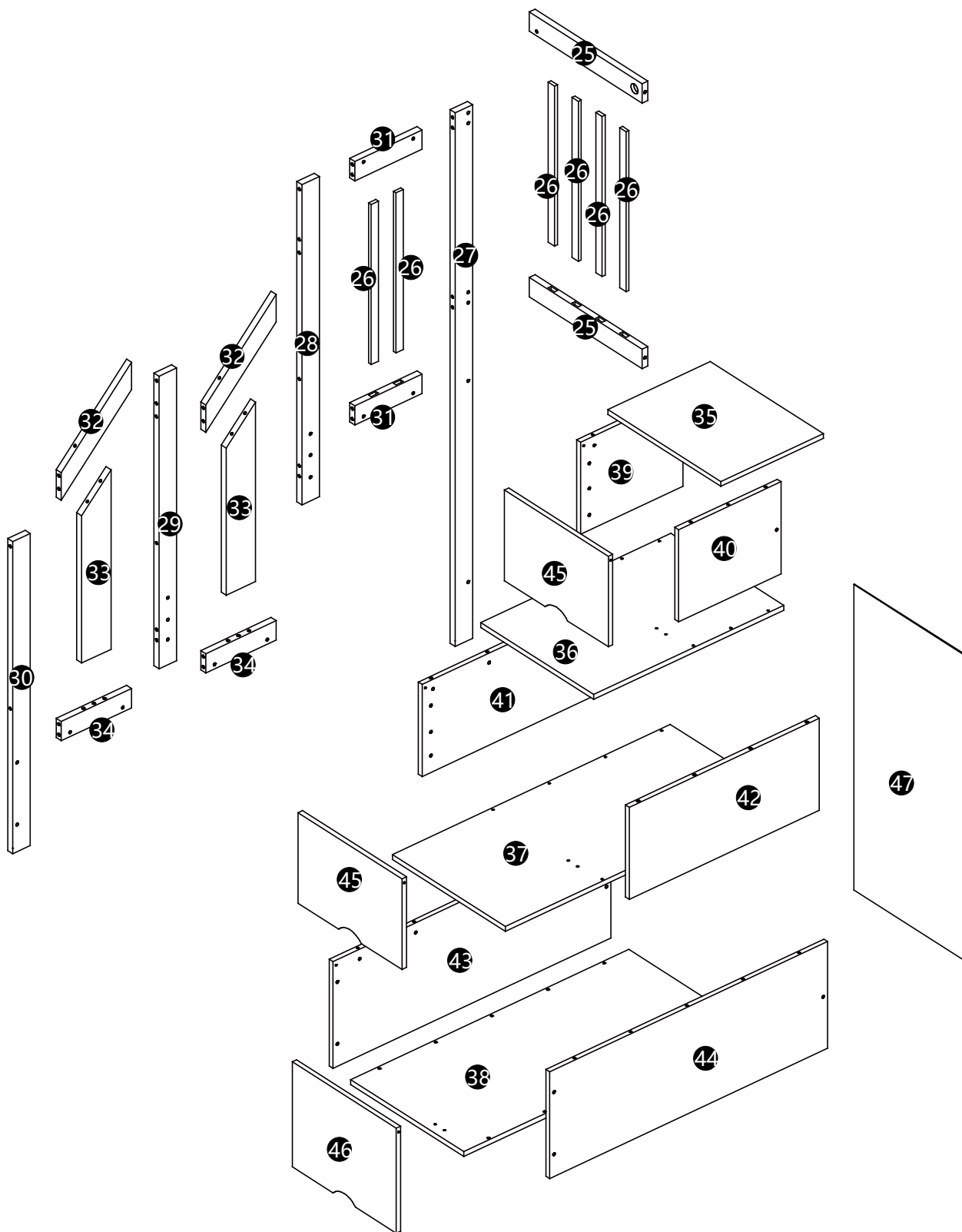

MONTAGEANLEITUNG/ASSEMBLY INSTRUCTIONS

TEILELIST

N606P345836

1		1pc	19		1pc
2		1pc	20		1pc
3		1pc	21		1pc
4		1pc	24		2pcs
5		4pcs	26		6pcs
6		2pcs	27		1pc
7		1pc	28		1pc
8		2pcs	30		1pc
15		1pc	49		1pc
16		1pc	51		2pcs











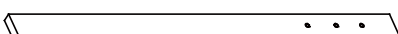
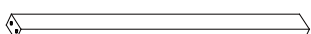
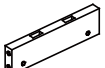



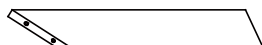

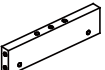
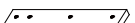
N606P345838

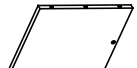
35		1pc	44		1pc
36		1pc	45		2pcs
37		1pc	46		1pc
38		1pc	47		1pc
43		1pc			

MONTAGEANLEITUNG/ASSEMBLY INSTRUCTIONS



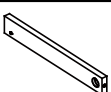



















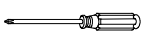

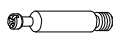
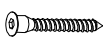



TEILELIST



N606P345837

9		1pc	29		1pc
10		1pc	31		2pcs
11		1pc	32		2pcs
12		3pcs	33		2pcs
13		1pc	34		2pcs
14		3pcs	39		1pc
17		1pc	40		1pc
18		3pcs	41		1pc
22		4pcs	42		1pc
23		1pc	48		2pcs
25		2pcs	50		1pc

MONTAGEANLEITUNG/ASSEMBLY INSTRUCTIONS

List der Hardware (N606P345836)

A	M0.6x10 	29PCS	O	M0.6x6.5 	7PCS
B	M0.6x7 	14PCS	P		12PCS
C	Ø1x1.3 	46PCS	Q	Ø0.6x9 	8PCS
D	Ø0.8x3 	61PCS	R	Ø0.6x7 	4PCS
E	Ø0.4x3 	63PCS	S	 	3PCS
F	M4 	2PCS	T	Ø0.3x1.4 	12PCS
G		1PC	U		6PCS
H	Ø 0.65x3.5 	24PCS	V	Ø0.5x4 	44PCS
I	  	2PCS	W	M0.6x2.5 	16PCS
J	Ø1.2x1 	24PCS	X	Ø0.7x5 	9PCS
K		2PCS	Y	M0.6x6 	4PCS
L	M0.6x2 	24PCS	Z		2PCS
M	M0.6x4 	2PCS	A1	Ø0.4x2.5 	5PCS
N	M3 	1PC			

A	B	Y
		
M0.6*10	M0.6*7	M0.6*6

DE:Bitte beachten Sie, dass die Formen der Schrauben A und B und Y ähnlich sind. Bitte installieren Sie entsprechend der Anleitung und unterscheiden Sie sie!

UK:Please note that the shapes of screws A and B and Y are similar. Please install according to the instructions and distinguish them!

FR:Notez que les vis A et B et Y ont des formes similaires. Veuillez les installer en suivant les instructions pour les séparer!



IT:Si prega di notare che le forme delle viti A e B e Y sono simili. Si prega di installarle seguendo le istruzioni e di distinguerle!

ES:Por favor, tenga en cuenta que las formas de los tornillos A y B y Y son similares. Por favor, instálelos de acuerdo con las instrucciones y distíngalos.

NL:Let op, de vormen van schroeven A en B en Y zijn vergelijkbaar. Installeer volgens de instructies en maak onderscheid tussen ze!

SE:Observera att formerna på skruvarna A och B och Y är lika. Installera enligt anvisningarna och särskilj dem!

PL:Zauważ, że kształty śrub A i B i Y są podobne. Zainstaluj zgodnie z instrukcjami i rozróżnij je!

E	T	A1
		
Φ0.4*3	Φ0.3*1.4	Φ0.4*2.5

DE:Bitte beachten Sie, dass die Formen der Schrauben E und T und A1 ähnlich sind. Bitte installieren Sie entsprechend der Anleitung und unterscheiden Sie sie!

UK:Please note that the shapes of screws E and T and A1 are similar. Please install according to the instructions and distinguish them!

FR:Notez que les vis E et T et A1 ont des formes similaires. Veuillez les installer en suivant les instructions pour les séparer!



IT:Si prega di notare che le forme delle viti E e T e A1 sono simili. Si prega di installarle seguendo le istruzioni e di distinguerle!

ES:Por favor, tenga en cuenta que las formas de los tornillos E y T y A1 son similares. Por favor, instálelos de acuerdo con las instrucciones y distíngalos.

NL:Let op, de vormen van schroeven E en T en A1 zijn vergelijkbaar. Installeer volgens de instructies en maak onderscheid tussen ze!

SE:Observera att formerna på skruvarna E och T och A1 är lika. Installera enligt anvisningarna och särskilj dem!

PL:Zauważ, że kształty śrub E i T i A1 są podobne. Zainstaluj zgodnie z instrukcjami i rozróżnij je!

M	O	W
		
M0.6*4	M0.6*6.5	M0.6*2.5

DE:Bitte beachten Sie, dass die Formen der Schrauben M und O und W ähnlich sind. Bitte installieren Sie entsprechend der Anleitung und unterscheiden Sie sie!

UK:Please note that the shapes of screws M and O and W are similar. Please install according to the instructions and distinguish them!

FR:Notez que les vis M et O et W ont des formes similaires. Veuillez les installer en suivant les instructions pour les séparer!



IT:Si prega di notare che le forme delle viti M e O e W sono simili. Si prega di installarle seguendo le istruzioni e di distinguerle!

ES:Por favor, tenga en cuenta que las formas de los tornillos M y O y W son similares. Por favor, instálelos de acuerdo con las instrucciones y distíngalos.

NL:Let op, de vormen van schroeven M en O en W zijn vergelijkbaar. Installeer volgens de instructies en maak onderscheid tussen ze!

SE:Observera att formerna på skruvarna M och O och W är lika. Installera enligt anvisningarna och särskilj dem!

PL:Zauważ, że kształty śrub M i O i W są podobne. Zainstaluj zgodnie z instrukcjami i rozróżnij je!

Q	R
	
Φ0.6*9	Φ0.6*7

DE:Bitte beachten Sie, dass die Formen der Schrauben Q und R ähnlich sind. Bitte installieren Sie entsprechend der Anleitung und unterscheiden Sie sie!

UK:Please note that the shapes of screws Q and R are similar. Please install according to the instructions and distinguish them!

FR:Notez que les vis Q et R ont des formes similaires. Veuillez les installer en suivant les instructions pour les séparer!

IT:Si prega di notare che le forme delle viti Q e R sono simili. Si prega di installarle seguendo le istruzioni e di distinguerle!

ES:Por favor, tenga en cuenta que las formas de los tornillos Q y R son similares. Por favor, instálelos de acuerdo con las instrucciones y distíngalos.

NL:Let op, de vormen van schroeven Q en R zijn vergelijkbaar. Installeer volgens de instructies en maak onderscheid tussen ze!

SE:Observera att formerna på skruvarna Q och R är lika. Installera enligt anvisningarna och särskilj dem!

PL:Zauważ, że kształty śrub Q i R są podobne. Zainstaluj zgodnie z instrukcjami i rozróżnij je!

MONTAGEANLEITUNG/ASSEMBLY INSTRUCTIONS

Schritt 1

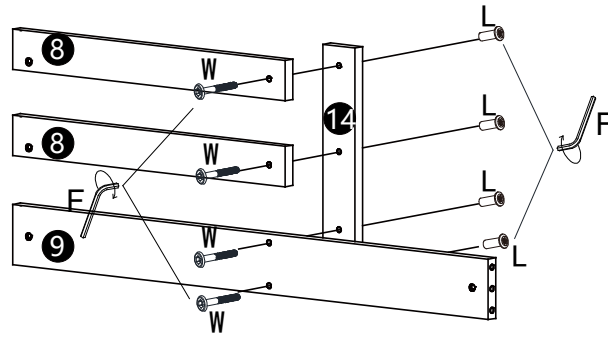

A	M0.6x10	
Y	M0.6x6	
M	M0.6x4	
O	M0.6x6.5	
Q	Ø0.6x9	

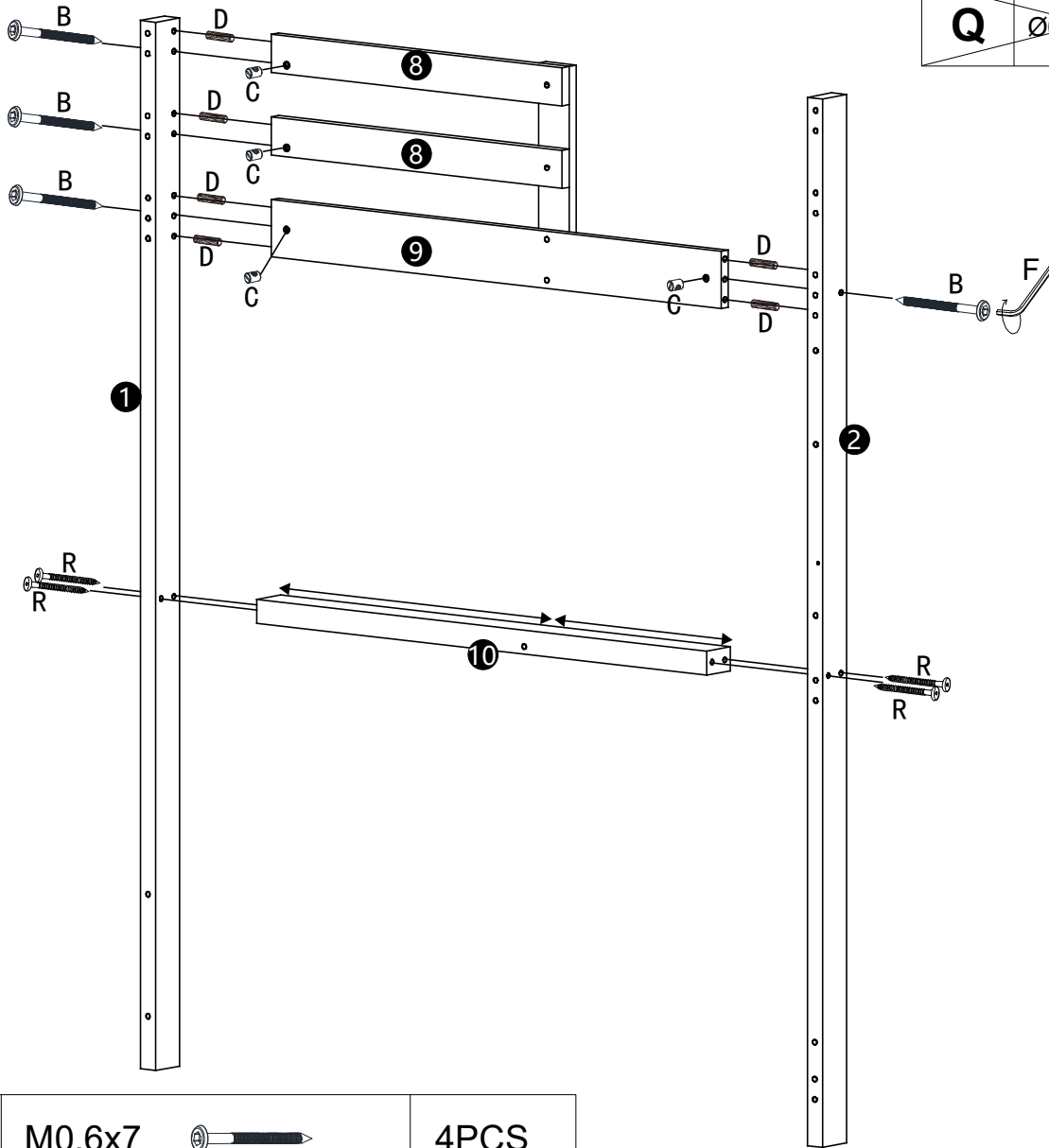





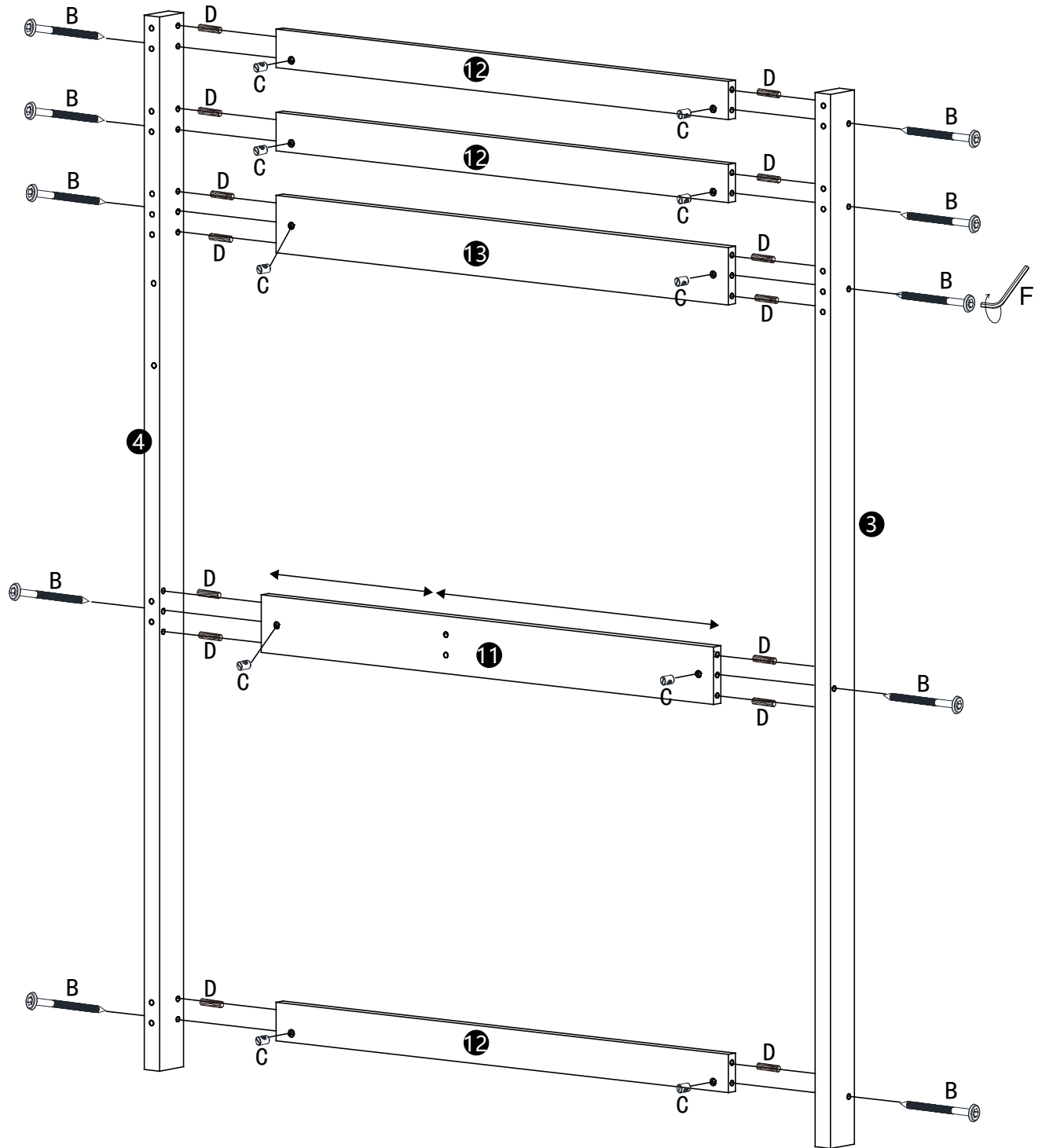

B	M0.6x7		4PCS		
C	Ø1x1.3		4PCS	D	Ø0.8x3 6PCS
L	M0.6x2		4PCS	F	M4 2PCS
R	Ø0.6x7		4PCS	W	M0.6x2.5 4PCS

MONTAGEANLEITUNG/ASSEMBLY INSTRUCTIONS

Schritt 2







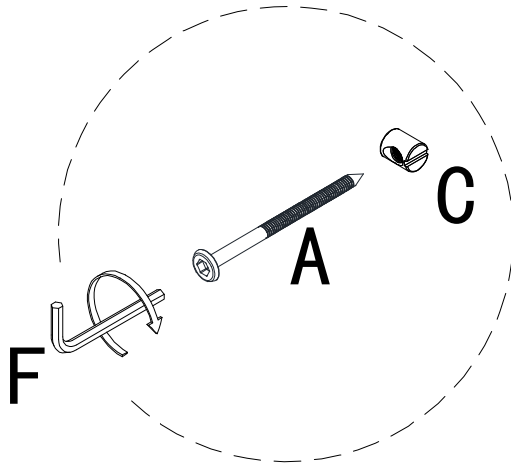
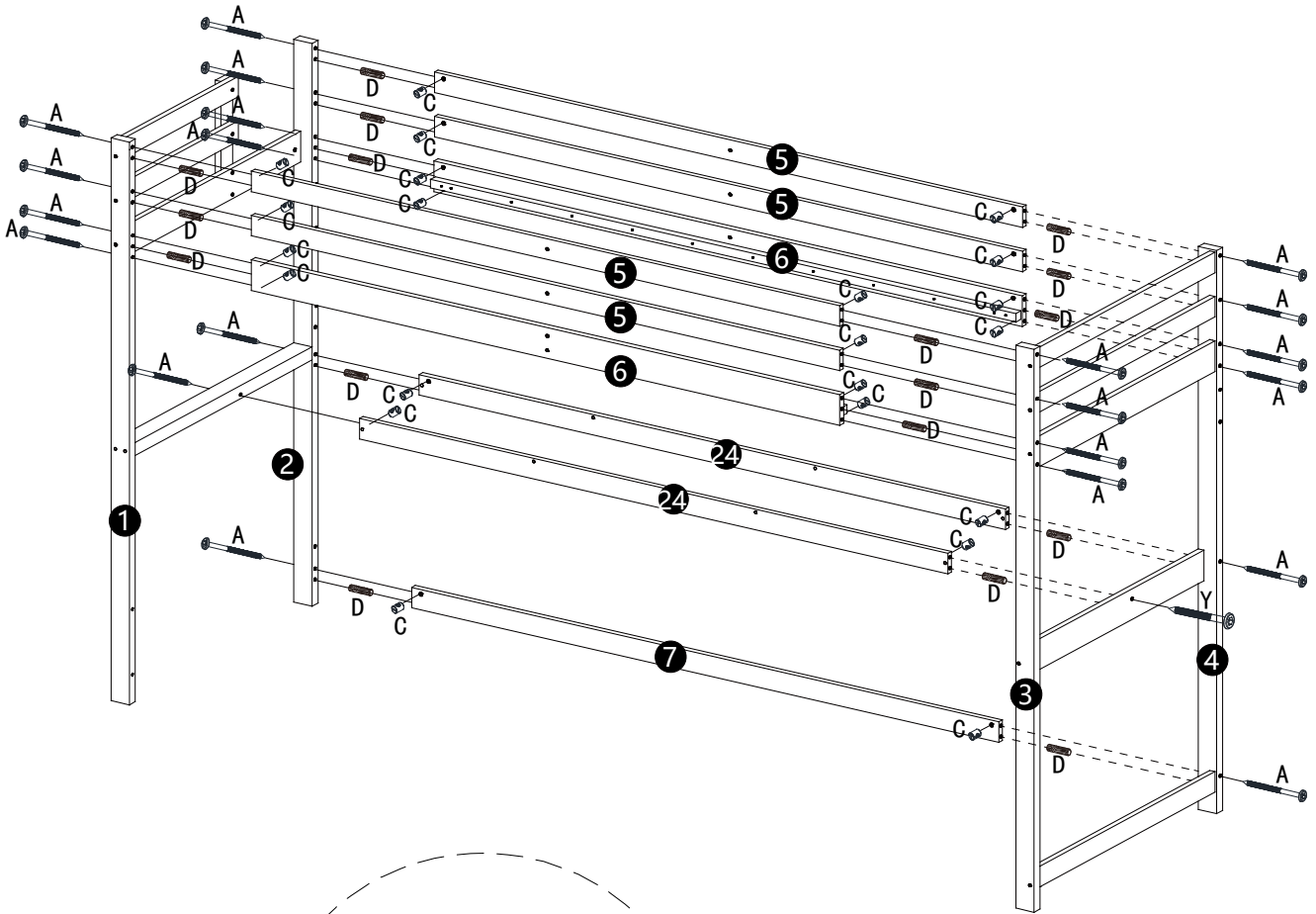

Y	M0.6x6		A	M0.6x10		
B	M0.6x7		10PCS	D	Ø0.8x3 	14PCS
C	Ø1x1.3		10PCS	F	M4 	1PC

MONTAGEANLEITUNG/ASSEMBLY INSTRUCTIONS

Schritt 3





A	M0.6x10		21PCS	B	M0.6x7		
C	Ø1x1.3		22PCS	F	M4		1PC
D	Ø0.8x3		17PCS	Y	M0.6x6		1PC

MONTAGEANLEITUNG/ASSEMBLY INSTRUCTIONS

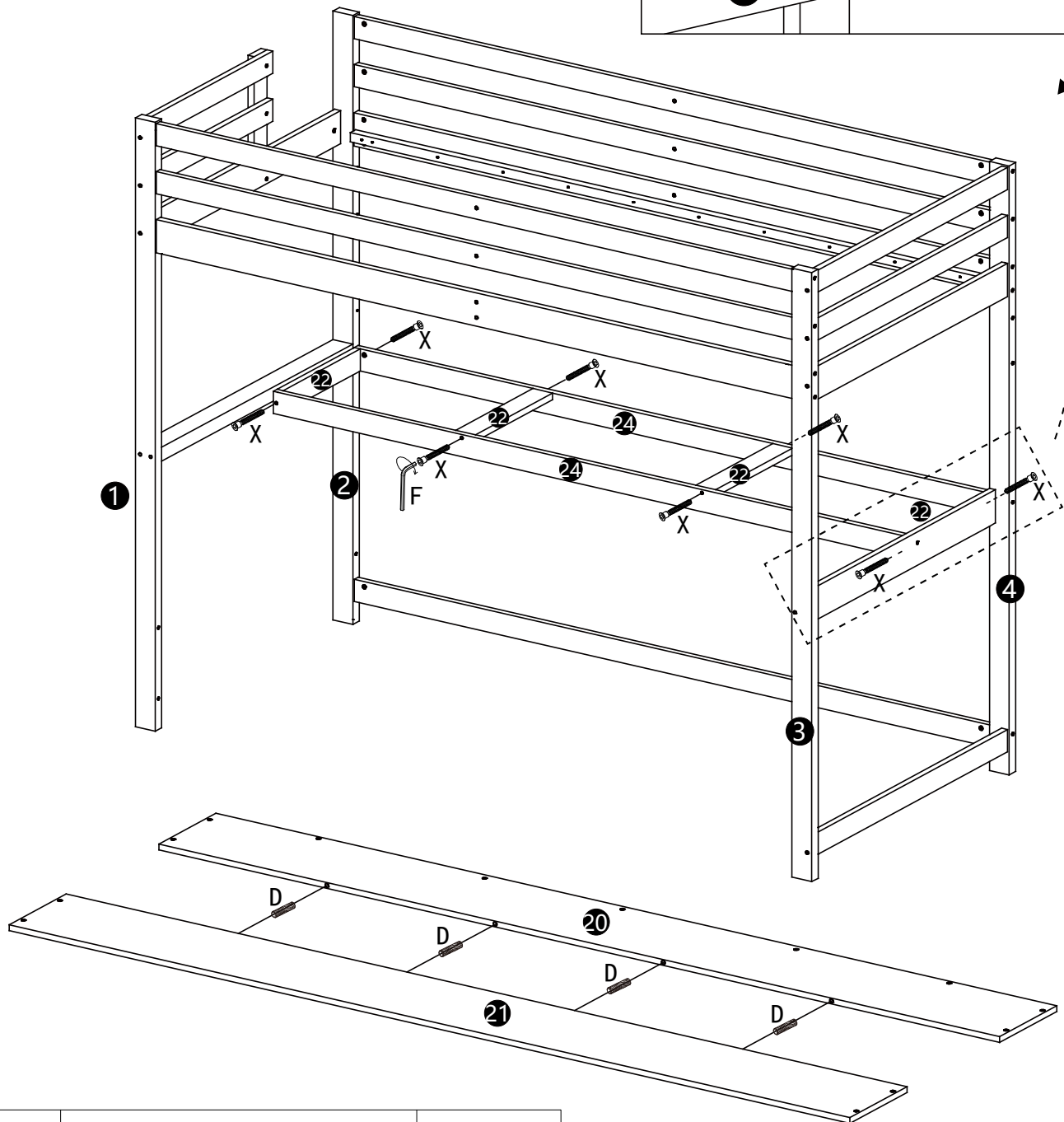
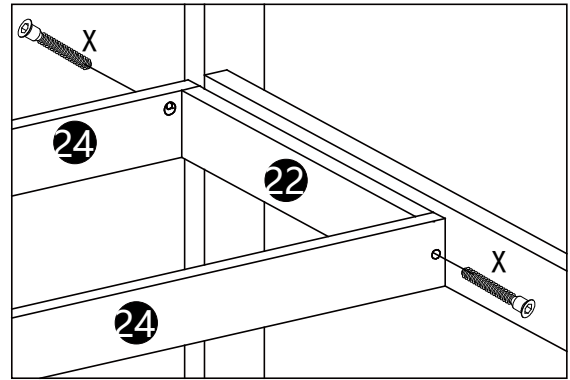
Schritt 4



F	M4		1PC			
X	Ø0.7x5		8PCS	D	Ø0.8x3	 4PCS

MONTAGEANLEITUNG/ASSEMBLY INSTRUCTIONS

Schritt 5

T	Ø0.3x1.4		M	M0.6x4	
A1	Ø0.4x2.5		O	M0.6x6.5	

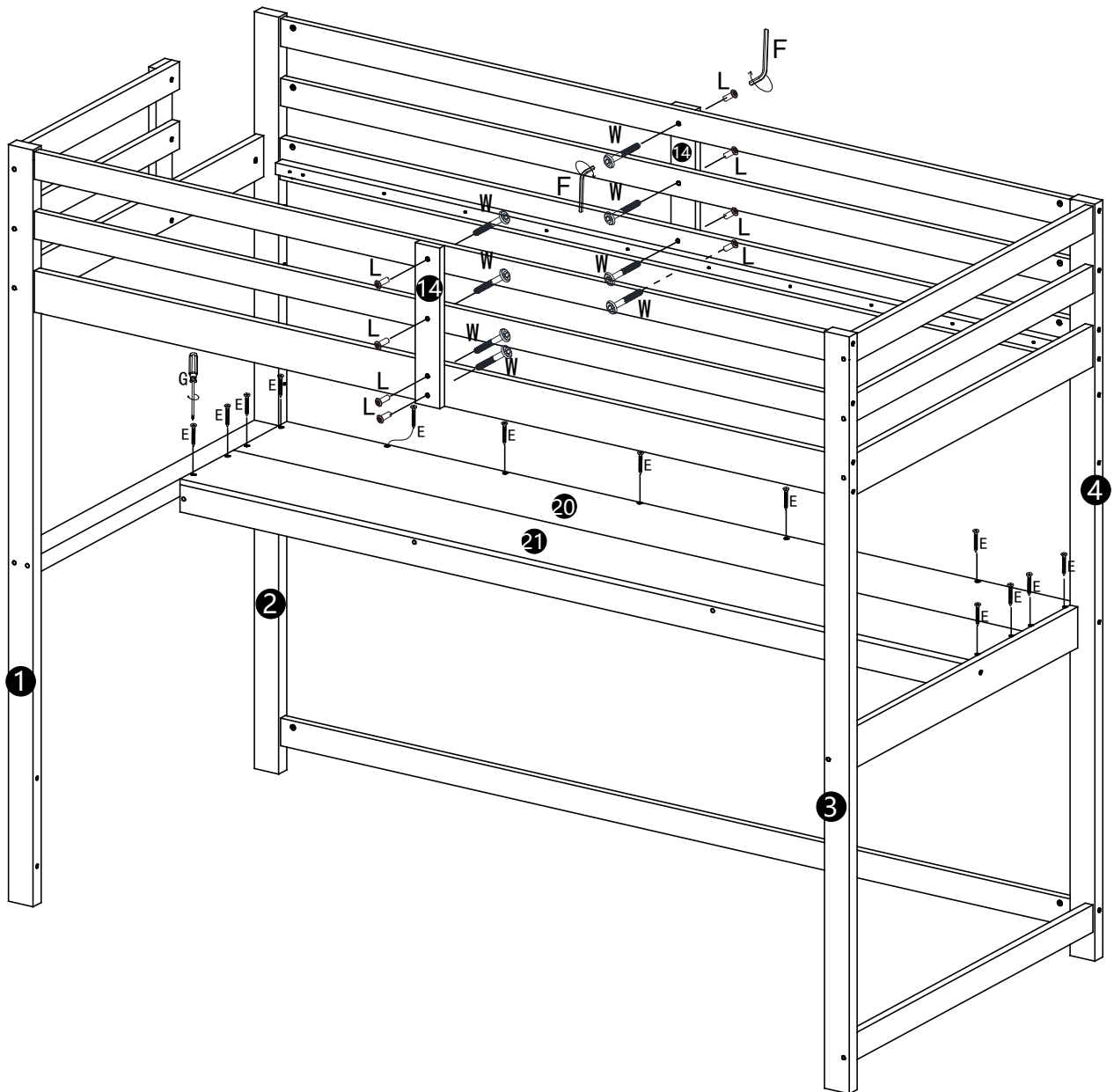

E	Ø0.4x3		13PCS				
G			1PC	F	M4		2PCS
L	M0.6x2		8PCS	W	M0.6x2.5		8PCS

MONTAGEANLEITUNG/ASSEMBLY INSTRUCTIONS

Schritt 6

A1
 $\varnothing 0.4 \times 2.5$

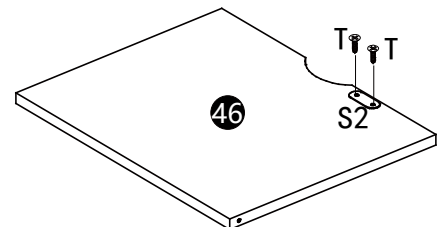
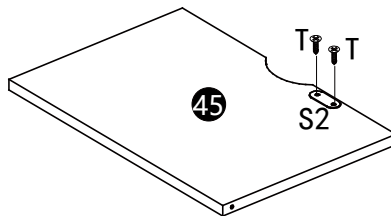
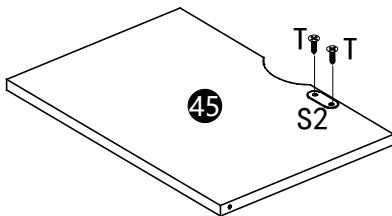
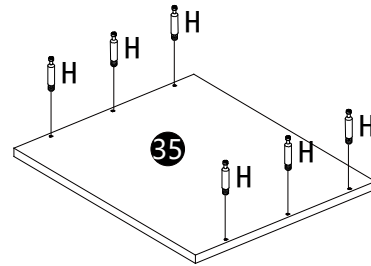
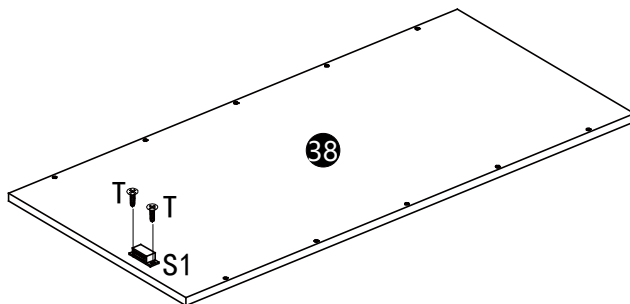
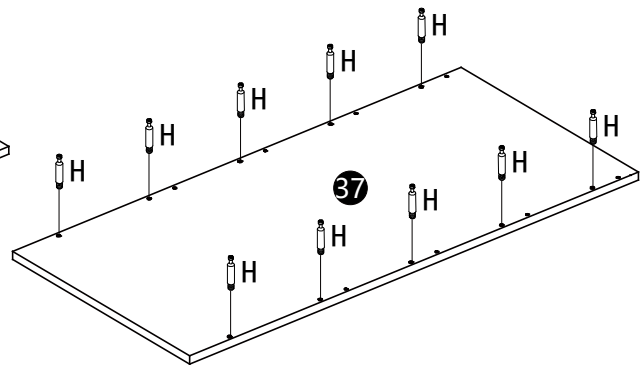
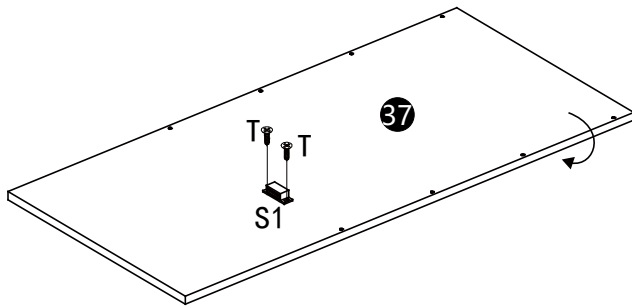
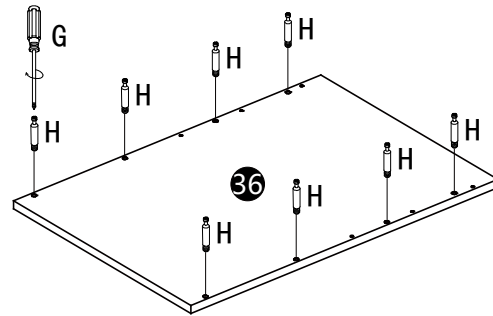
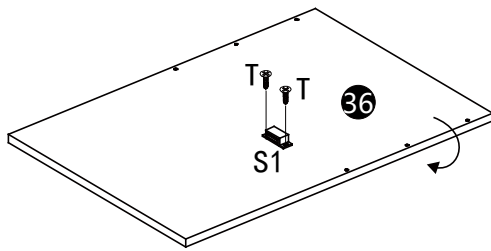
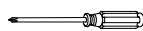
E
 $\varnothing 0.3 \times 3$

G

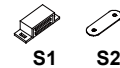
1PC

S

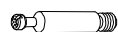
3PCS

H
 $\varnothing 0.65 \times 3.5$

24PCS





T
 $\varnothing 0.3 \times 1.4$

12PCS

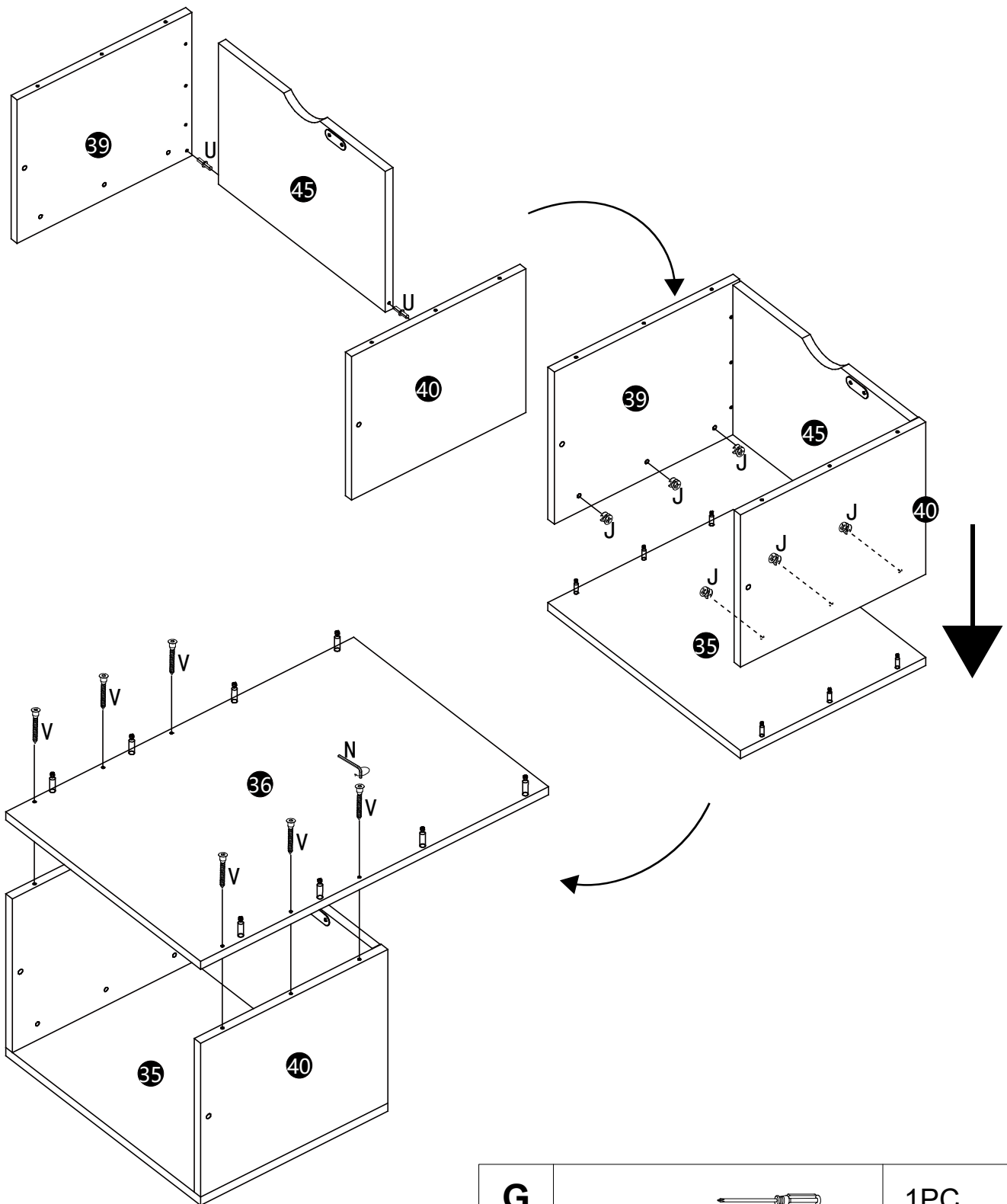
MONTAGEANLEITUNG/ASSEMBLY INSTRUCTIONS

Schritt 7





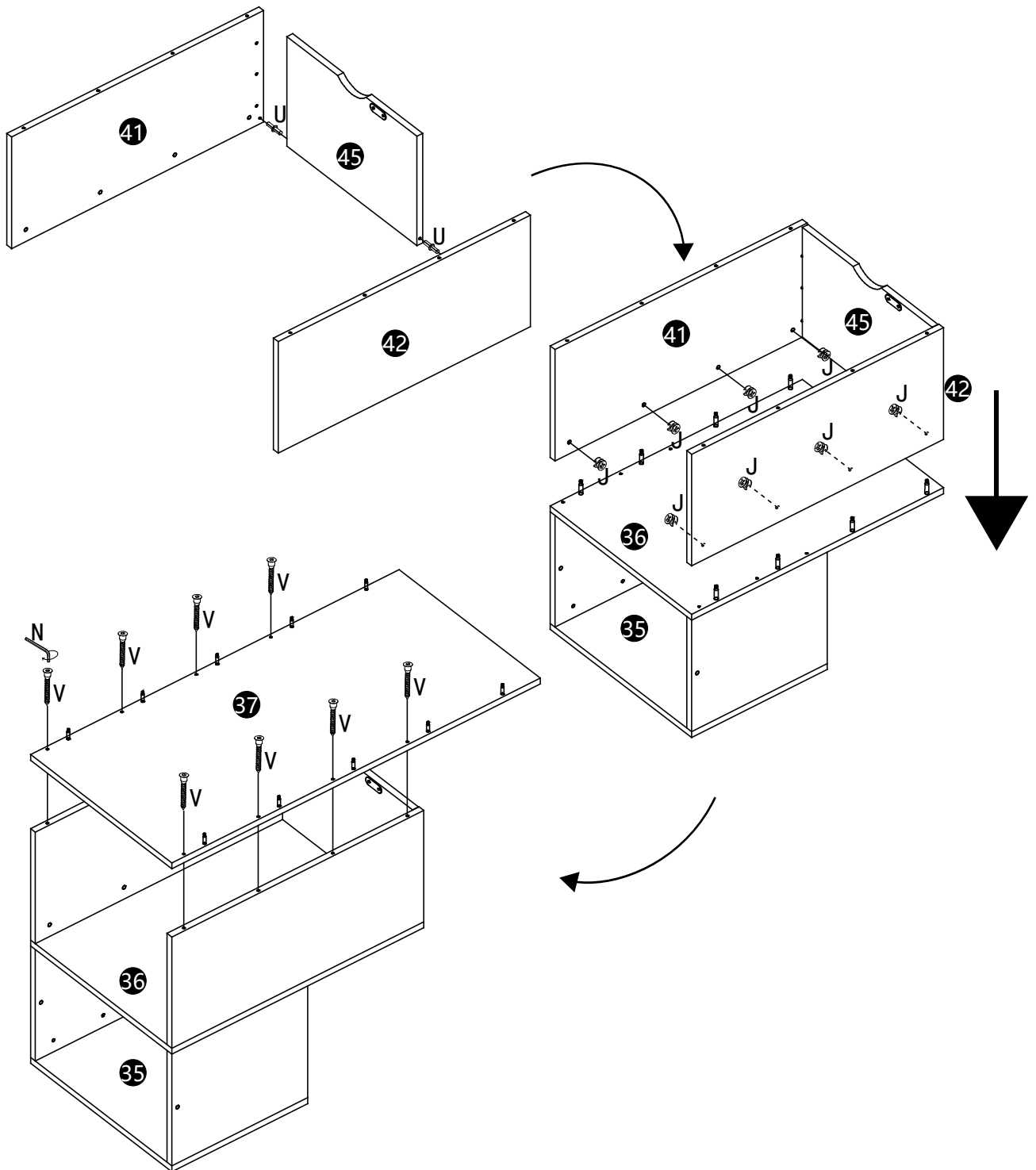

				G		1PC
J	Ø1.2x1		6PCS	U		2PCS
N	M3		1PC	V	Ø0.5x4 	6PCS

MONTAGEANLEITUNG/ASSEMBLY INSTRUCTIONS

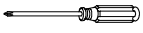
Schritt 8





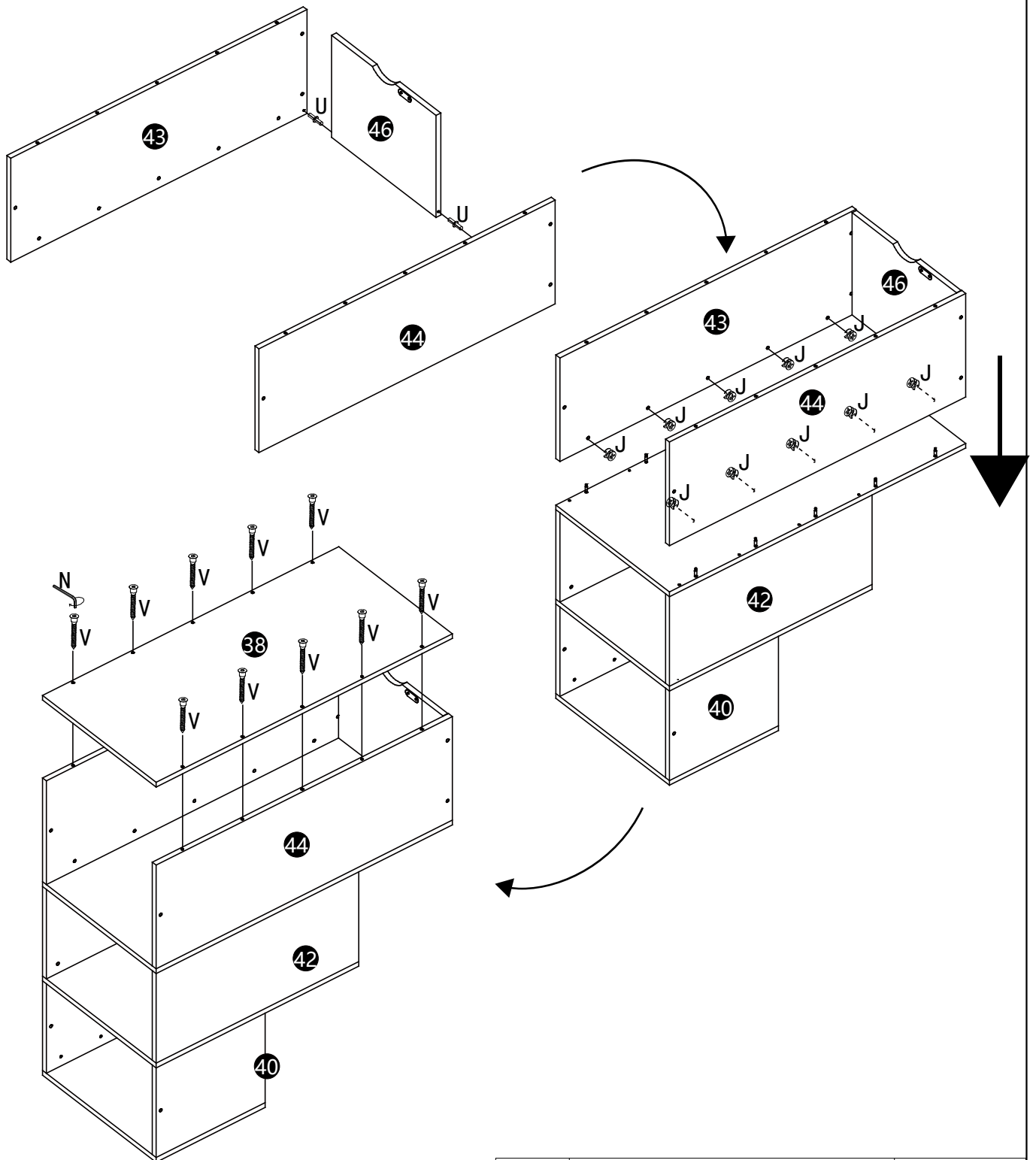

				G		1PC
J	Ø1.2x1		8PCS	U		2PCS
N	M3		1PC	V	Ø0.5x4 	8PCS

MONTAGEANLEITUNG/ASSEMBLY INSTRUCTIONS

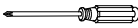

Schritt 9



				G		1PC
J	Ø1.2x1		10PCS	U		2PCS
N	M3		1PC	V	Ø0.5x4 	10PCS



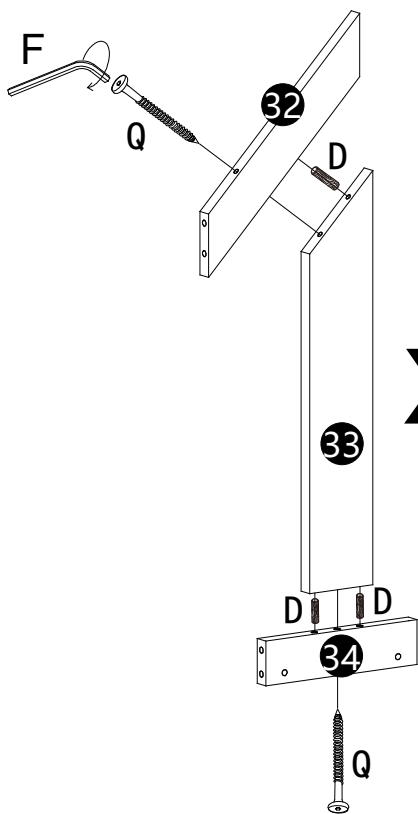
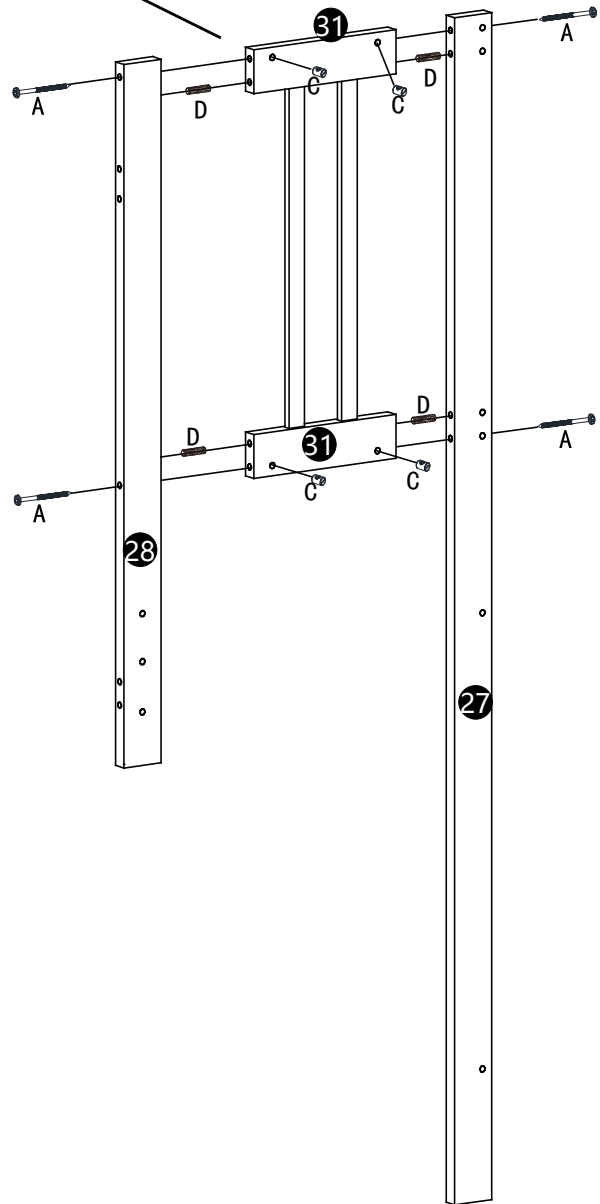
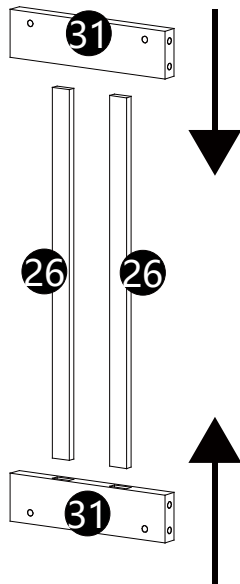

MONTAGEANLEITUNG/ASSEMBLY INSTRUCTIONS

Schritt 10

B	M0.6x7	
Y	M0.6x6	
R	Ø0.6x7	





x2





A	M0.6x10		4PCS
C	Ø1x1.3		4PCS
D	Ø0.8x3		10PCS
F	M4		1PC
Q	Ø0.6x9		4PCS

MONTAGEANLEITUNG/ASSEMBLY INSTRUCTIONS

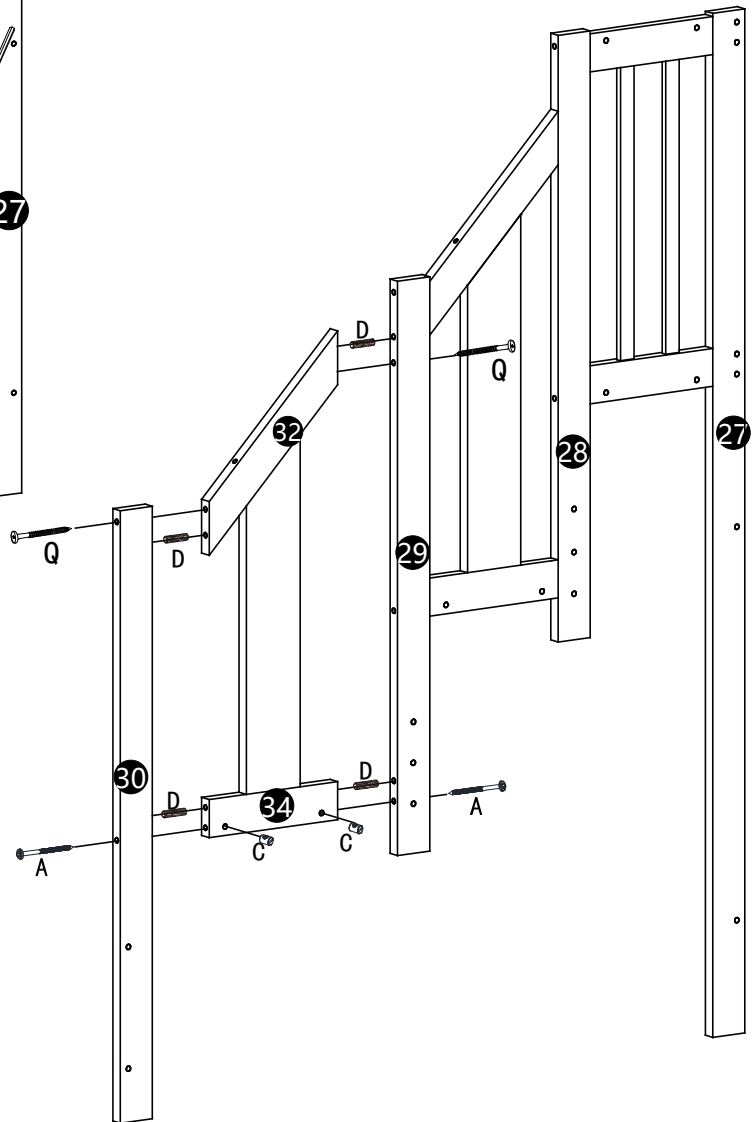
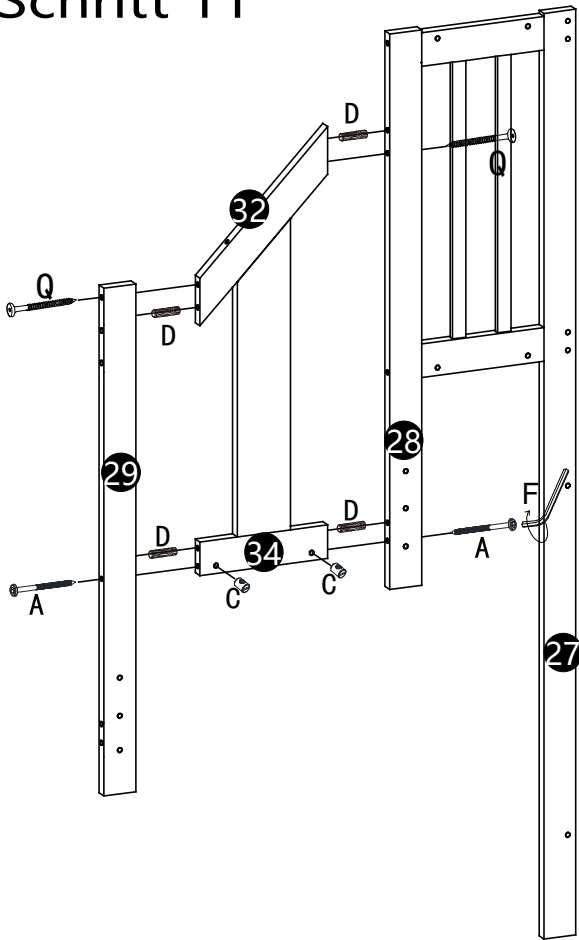
Schritt 11

B	M0.6x7	
Y	M0.6x6	
R	Ø0.6x7	



A	M0.6x10		4PCS
C	Ø1x1.3		4PCS
D	Ø0.8x3		8PCS
F	M4		1PC
Q	Ø0.6x9		4PCS

MONTAGEANLEITUNG/ASSEMBLY INSTRUCTIONS

Schritt 12

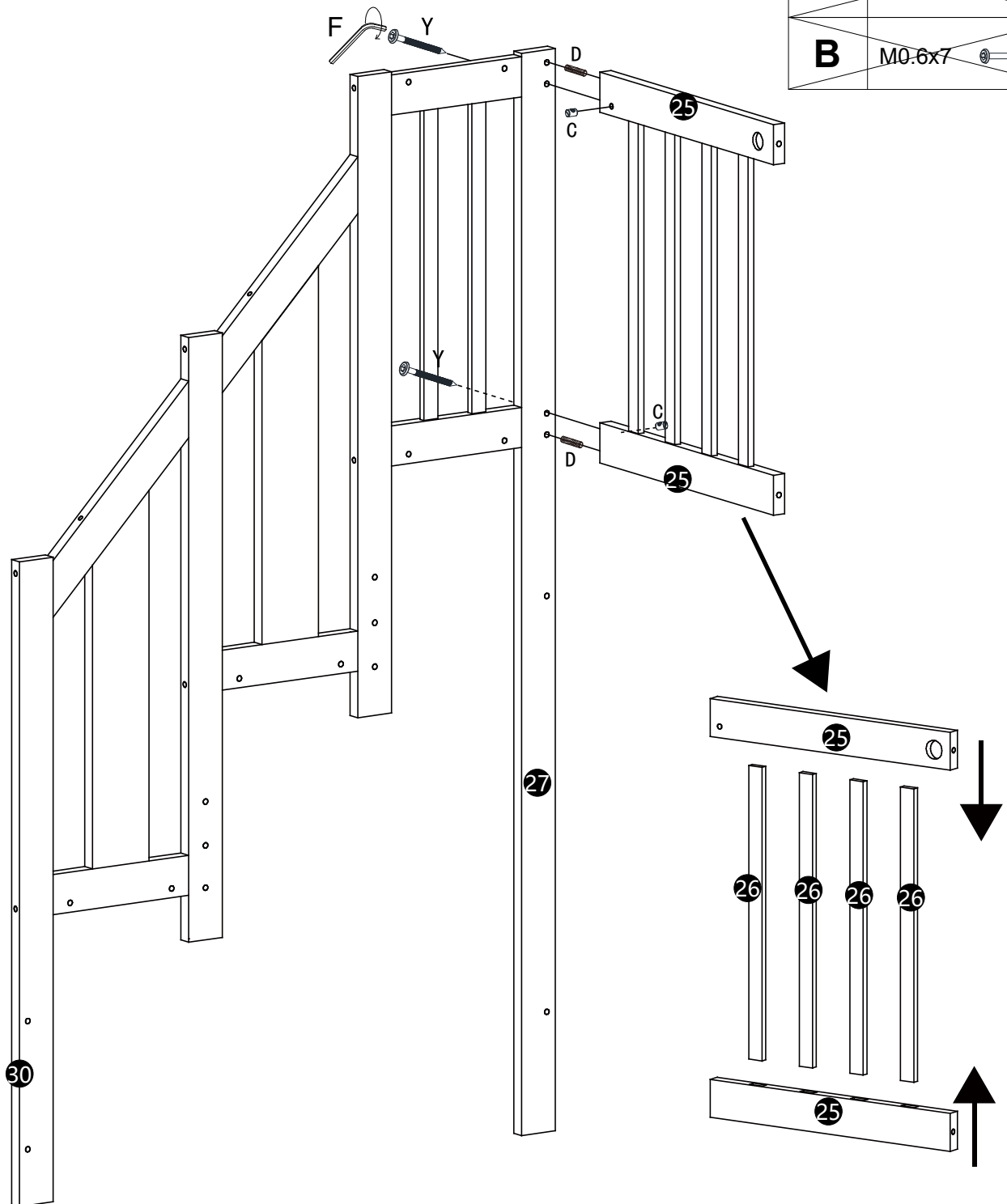



A	M0.6x10	
B	M0.6x7	



Y	M0.6x6		2PCS	D	Ø0.8x3		2PCS
C	Ø1x1.3		2PCS	F	M4		1PC

MONTAGEANLEITUNG/ASSEMBLY INSTRUCTIONS

Schritt 13

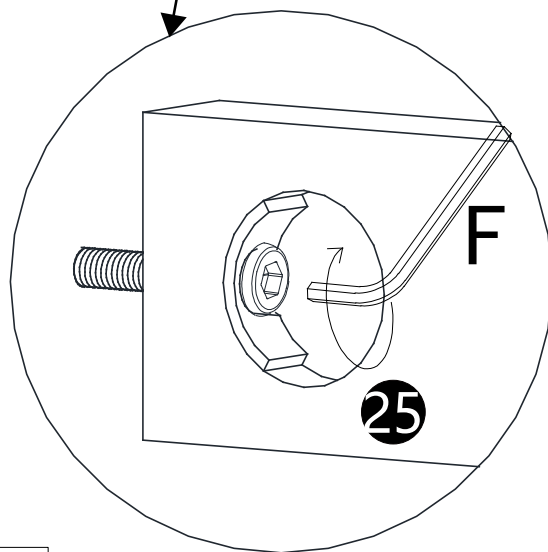
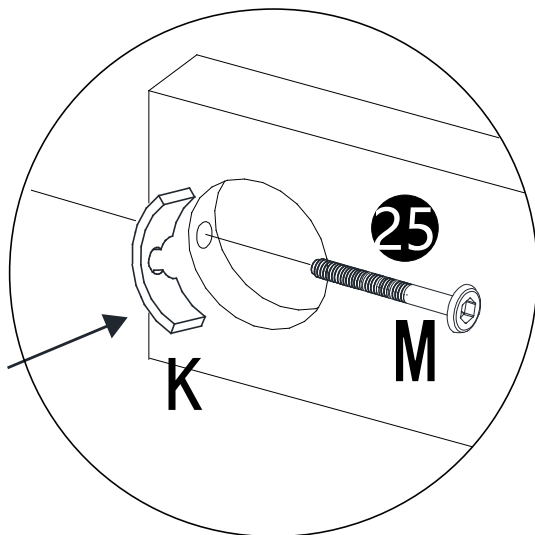
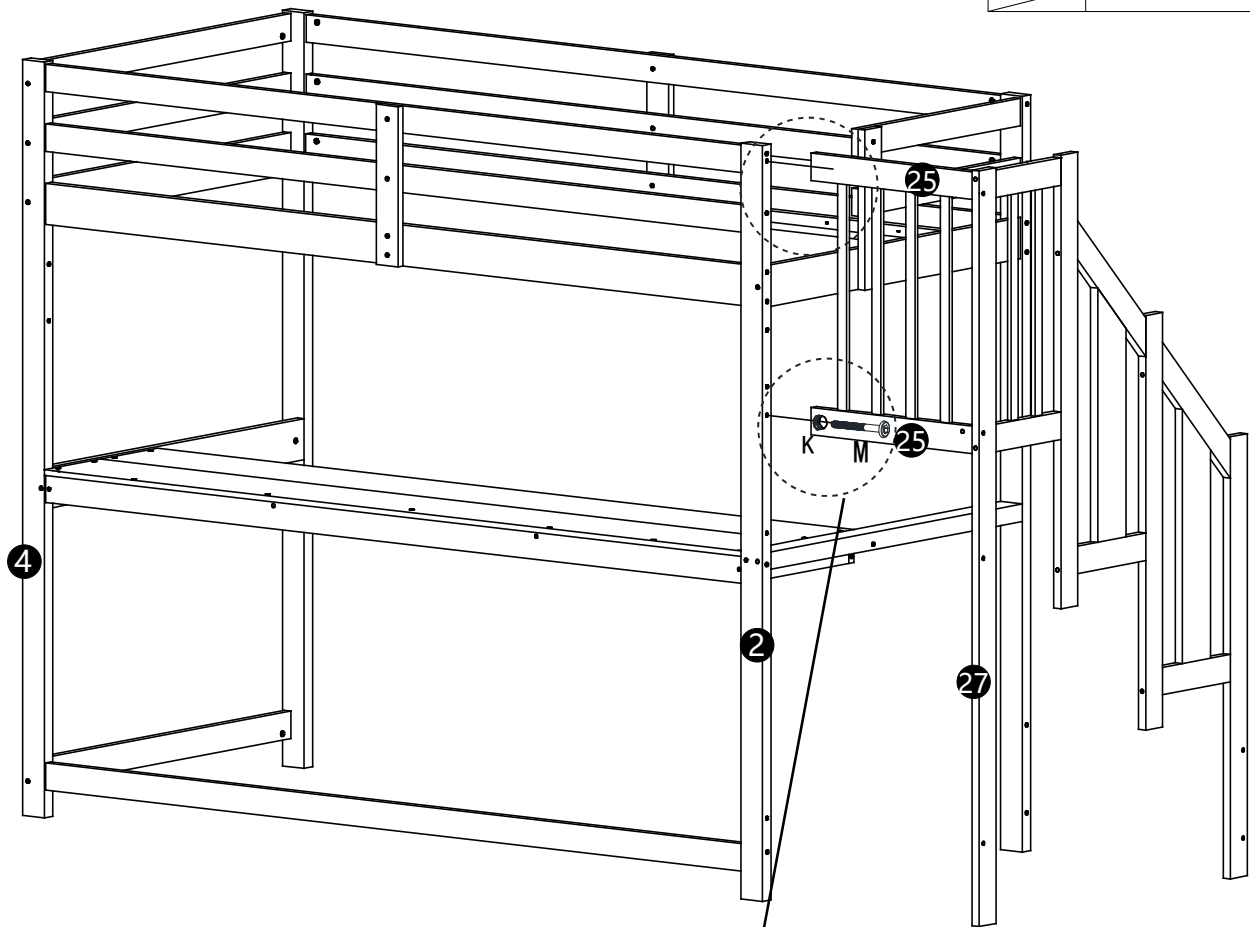
W	M0.6x2.5	
O	M0.6x6.5	



K			2PCS			
M	M0.6x4		2PCS	F	M4	
						1PC

Schritt 14

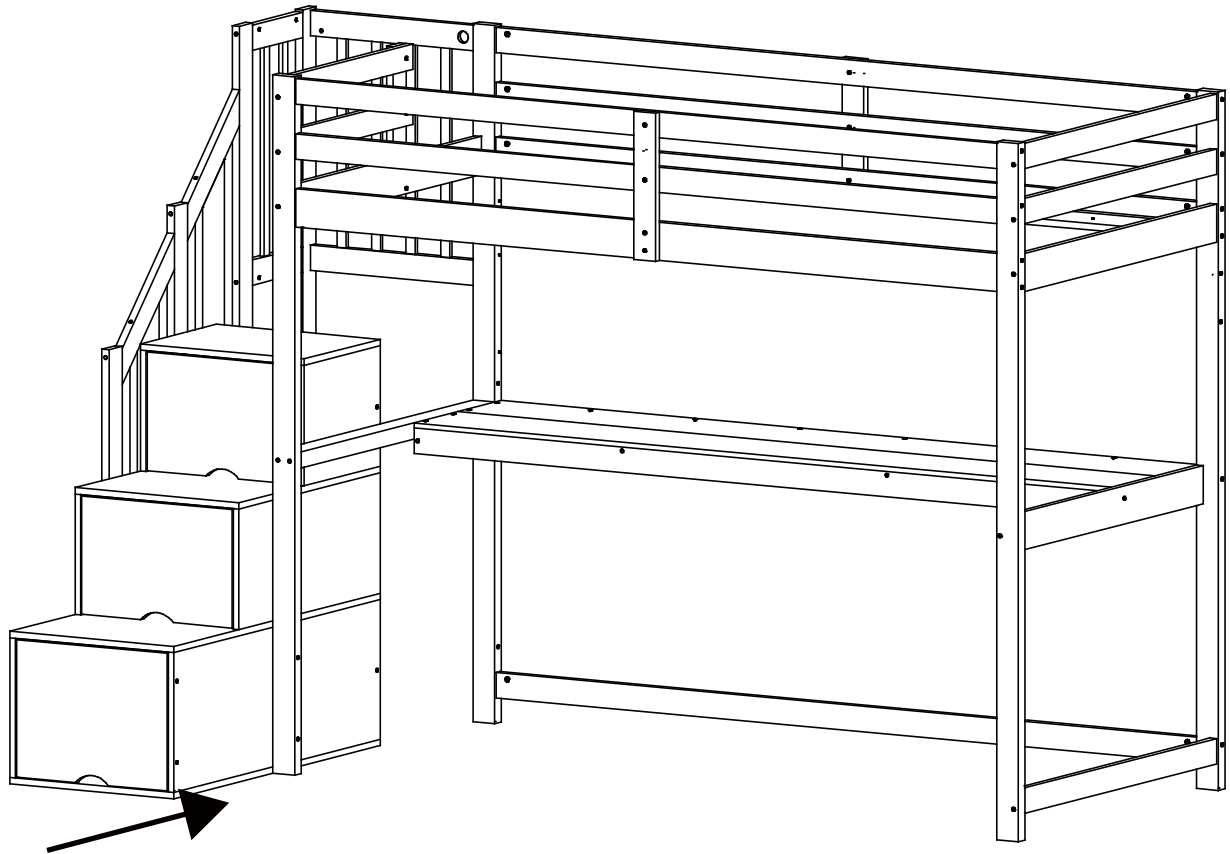

MONTAGEANLEITUNG/ASSEMBLY INSTRUCTIONS





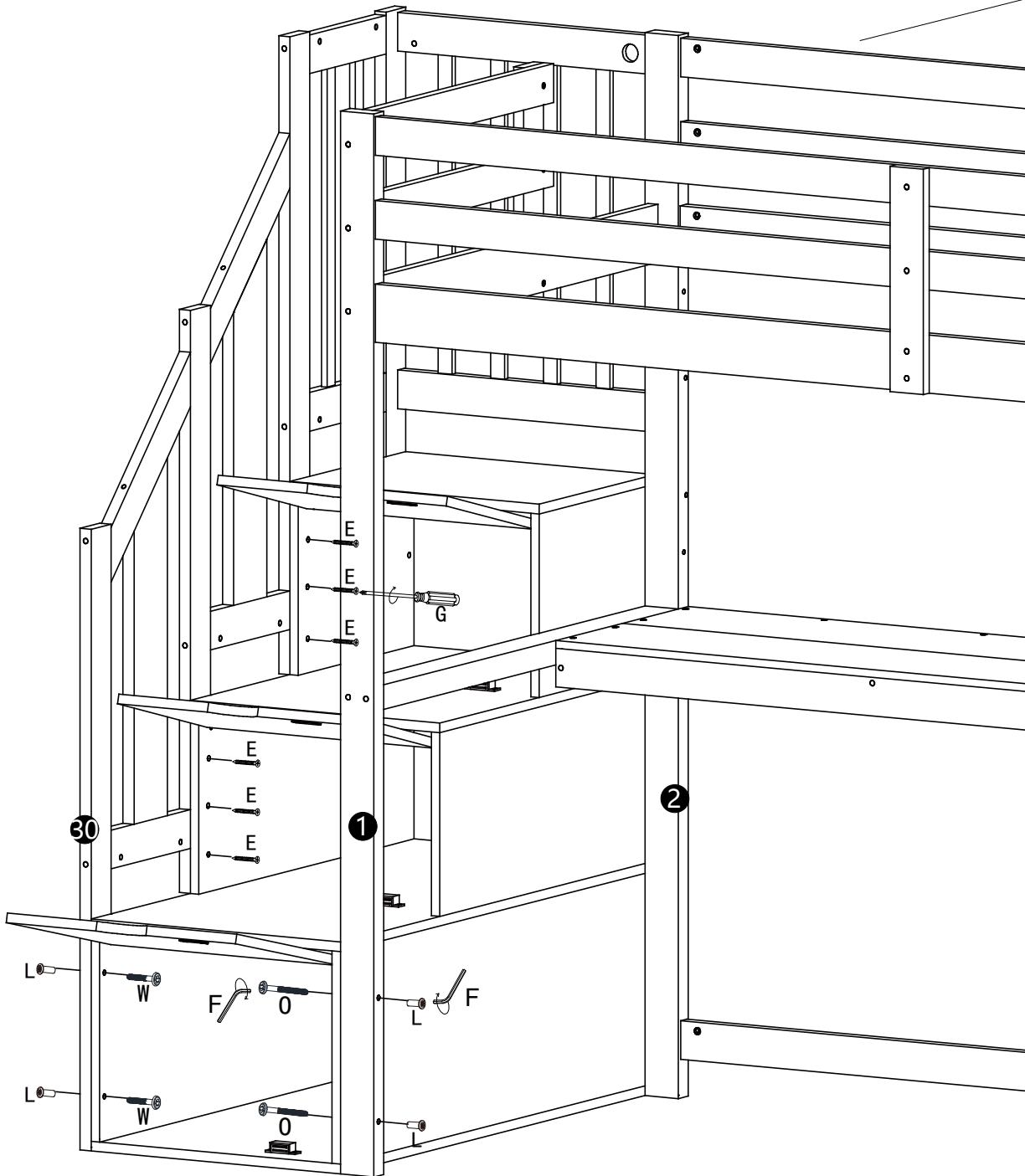

Schritt 15

A1 Ø0.4x2.5 

T Ø0.3x1.4 

M M0.6x4 





G		1PC	E	Ø0.4x3 	6PCS
F	M4 	2PCS	O	M0.6x6.5 	2PCS
L	M0.6x2 	4PCS	W	M0.6x2.5 	2PCS

MONTAGEANLEITUNG/ASSEMBLY INSTRUCTIONS

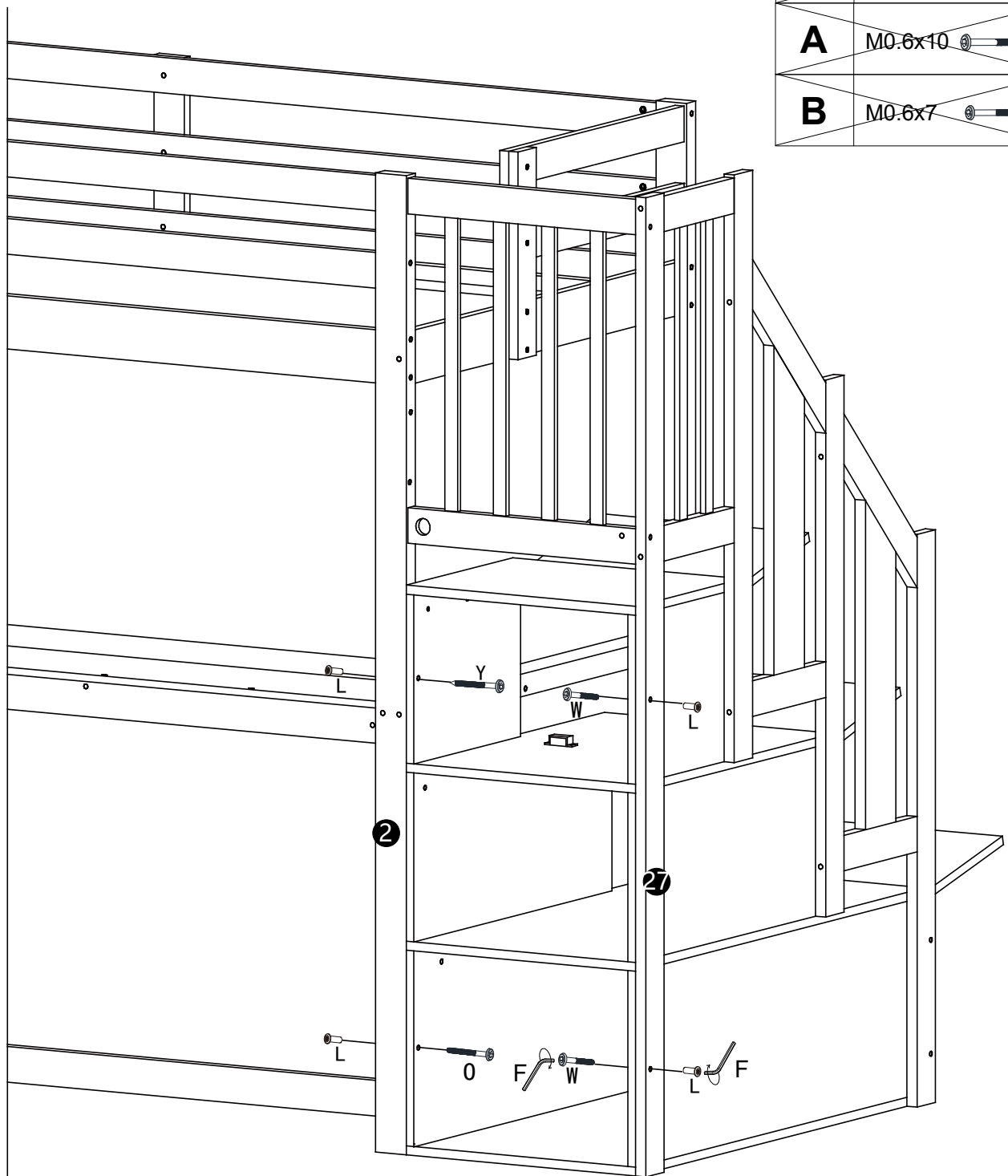
Schritt 16



M M0.6x4 

A M0.6x10 

B M0.6x7 

Y M0.6x6  1PC

F M4  2PCS

O M0.6x6.5  1PC

L M0.6x2  4PCS

W M0.6x2.5  2PCS

Schritt 17

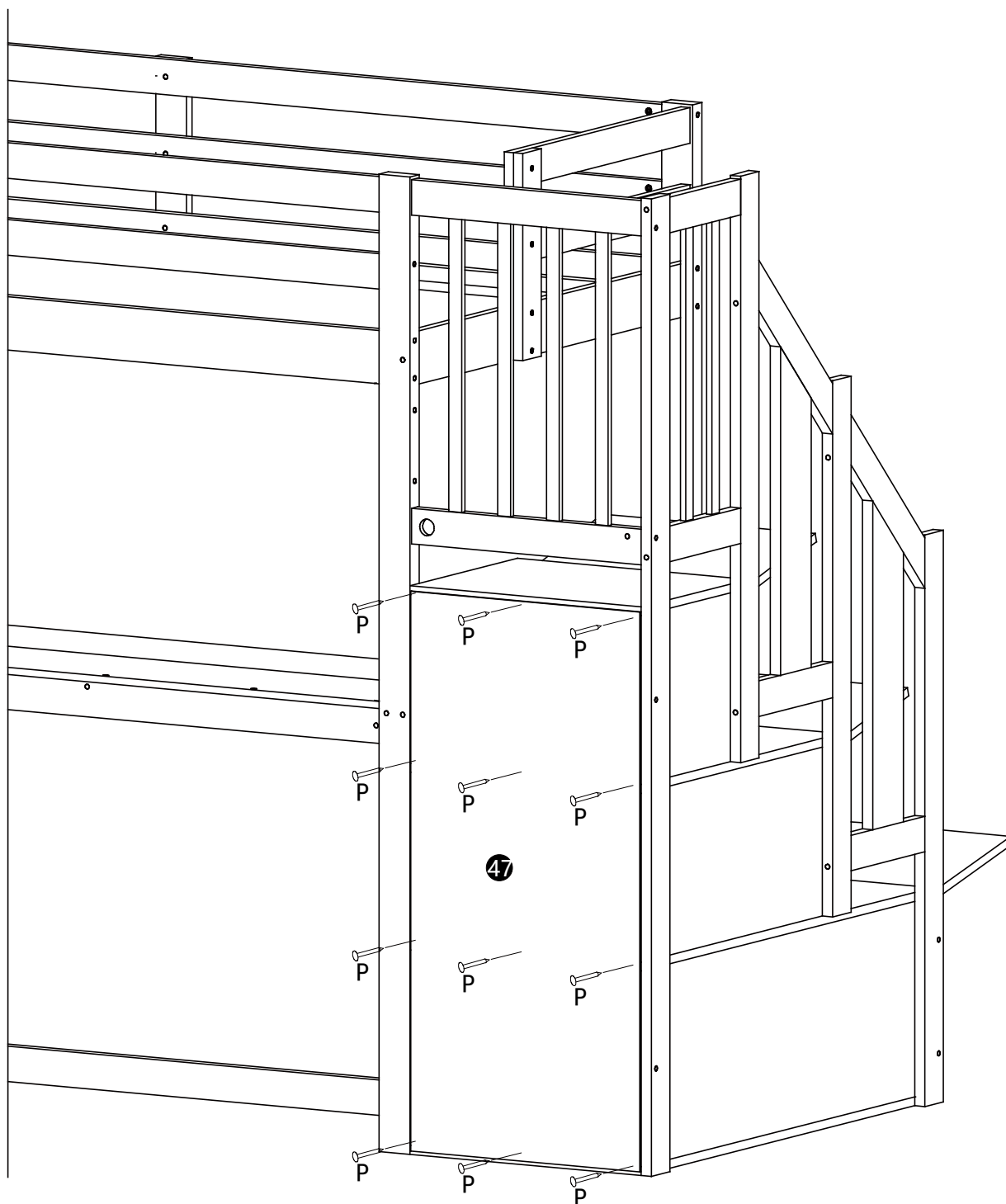

P



12PCS

MONTAGEANLEITUNG/ASSEMBLY INSTRUCTIONS

Schritt 18

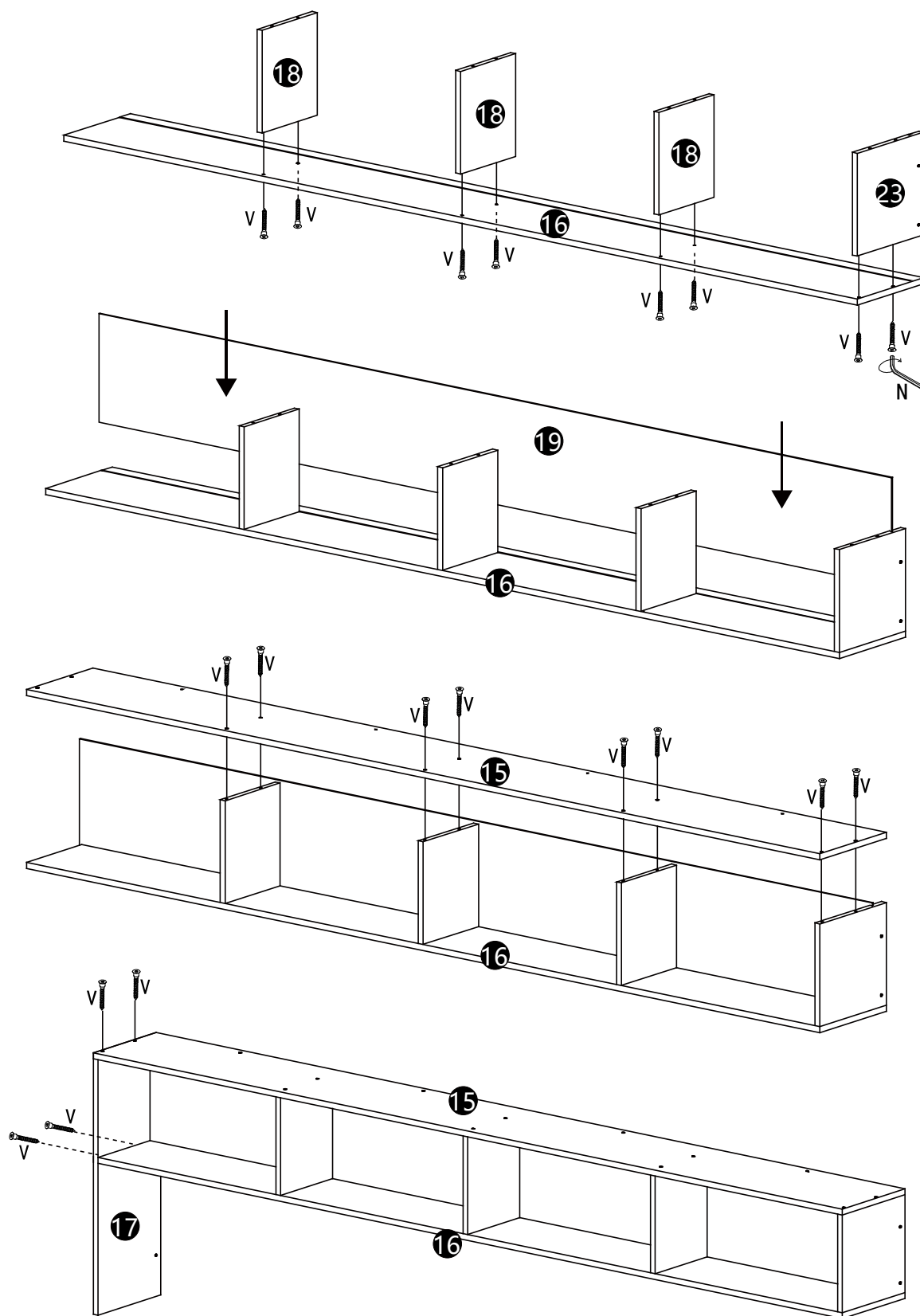

N

M3



1PC

V





Ø0.5x4







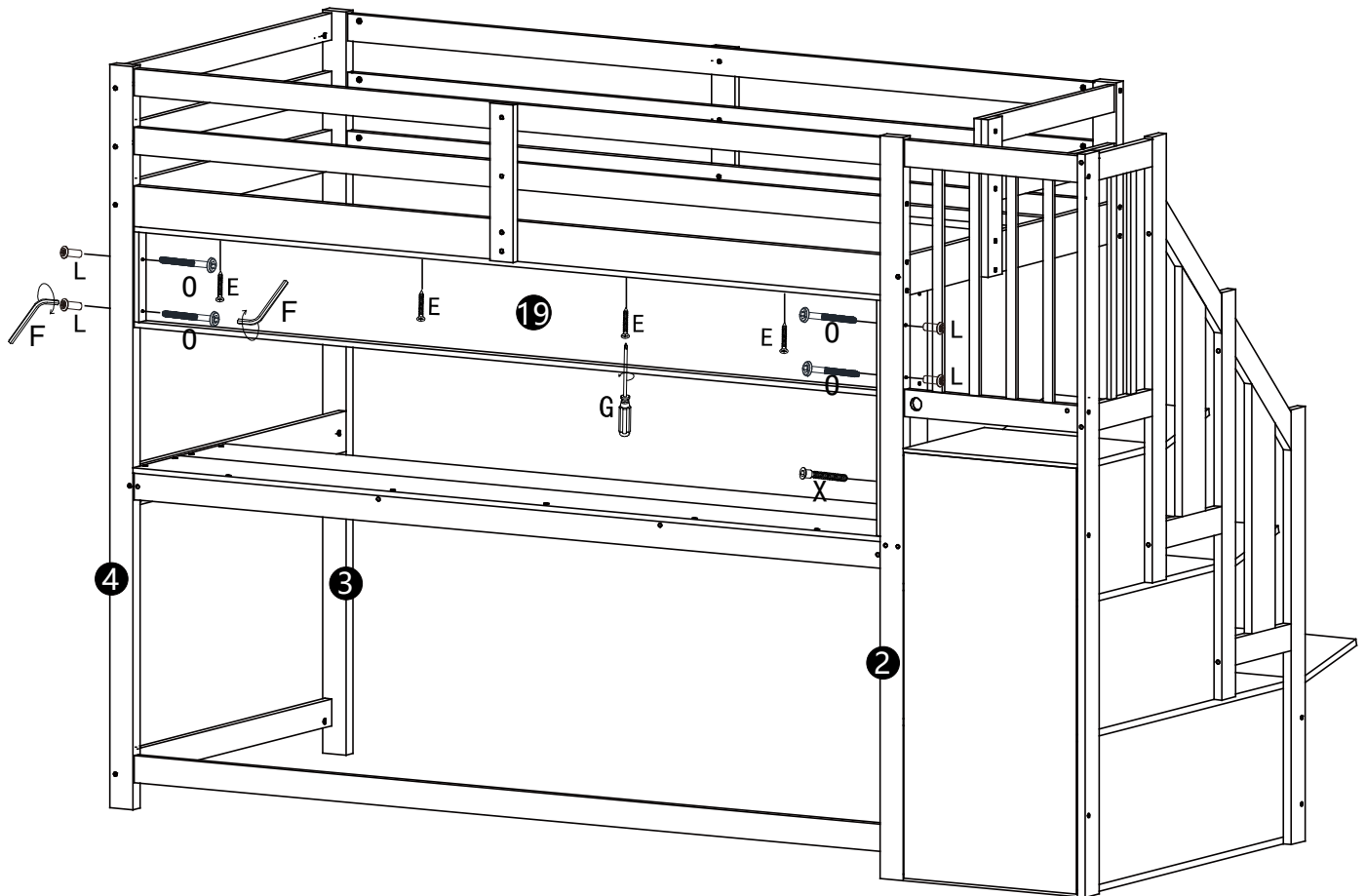

20PCS

MONTAGEANLEITUNG/ASSEMBLY INSTRUCTIONS

Schritt 19

A1	Ø0.4x2.5		T	Ø0.3x1.4	
W	M0.6x2.5		M	M0.6x4	

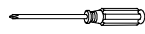

L	M0.6x2		4PCS	O	M0.6x6.5		4PCS
E	Ø0.4x3		4PCS	G			1PC
F	M4		1PC	X	Ø0.7x5		1PC

MONTAGEANLEITUNG/ASSEMBLY INSTRUCTIONS

Schritt 20

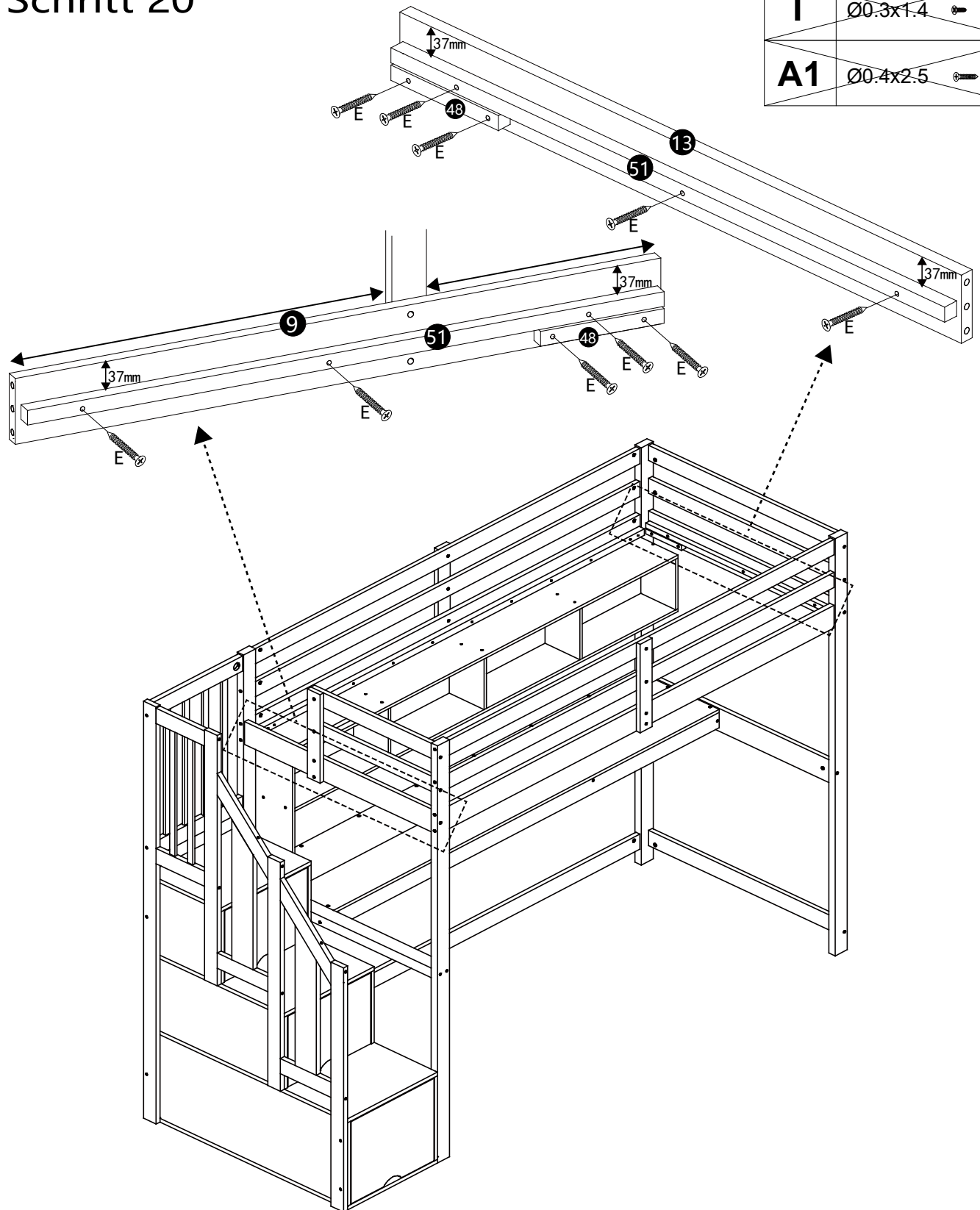

T	Ø0.3x1.4	
A1	Ø0.4x2.5	

E	Ø0.4x3		10PCS	G		1PC
----------	--------	--	-------	----------	--	-----

MONTAGEANLEITUNG/ASSEMBLY INSTRUCTIONS

Schritt 21

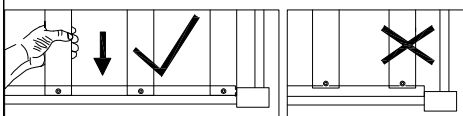
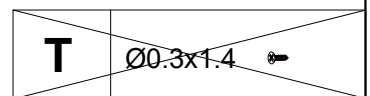
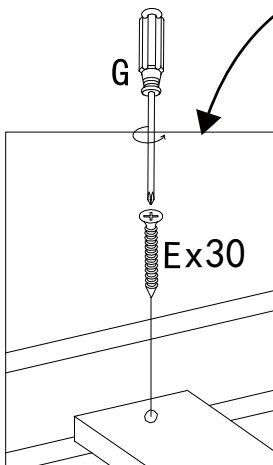
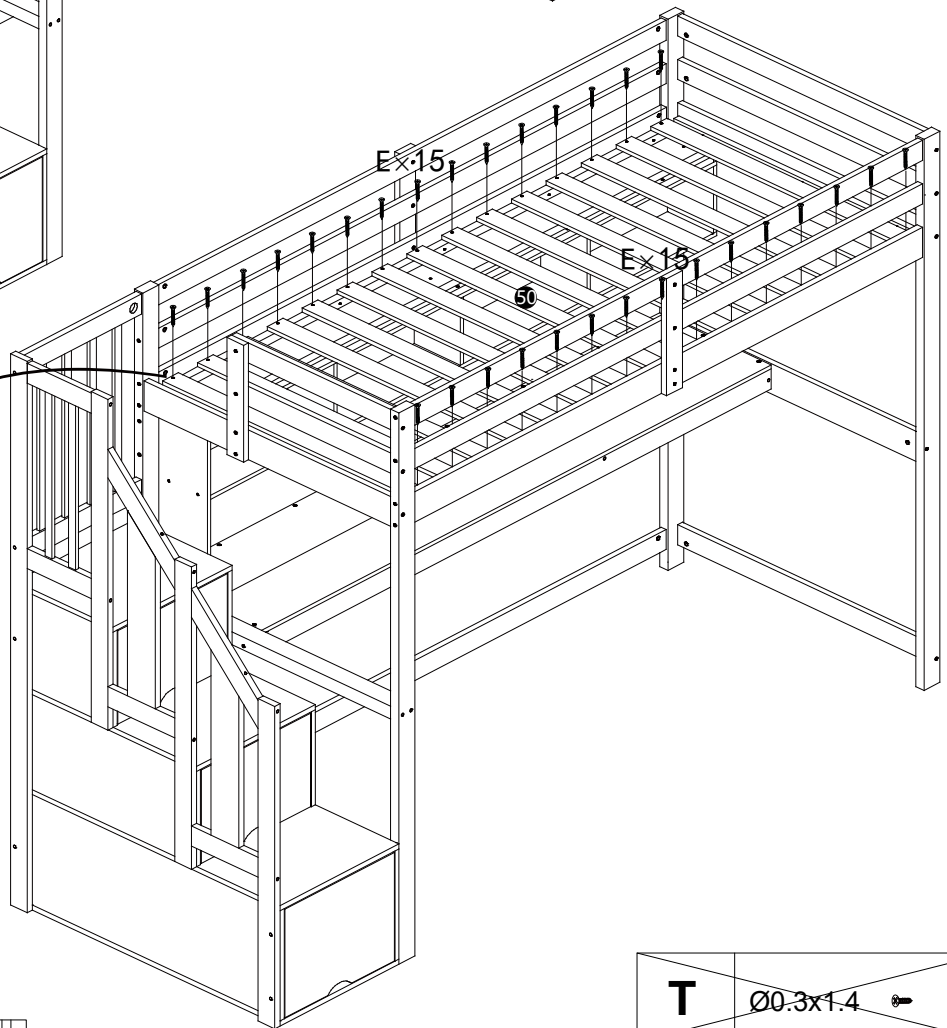
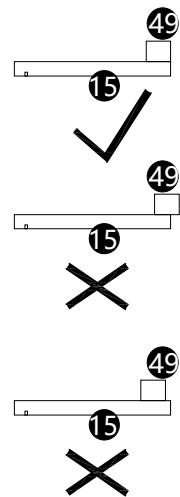
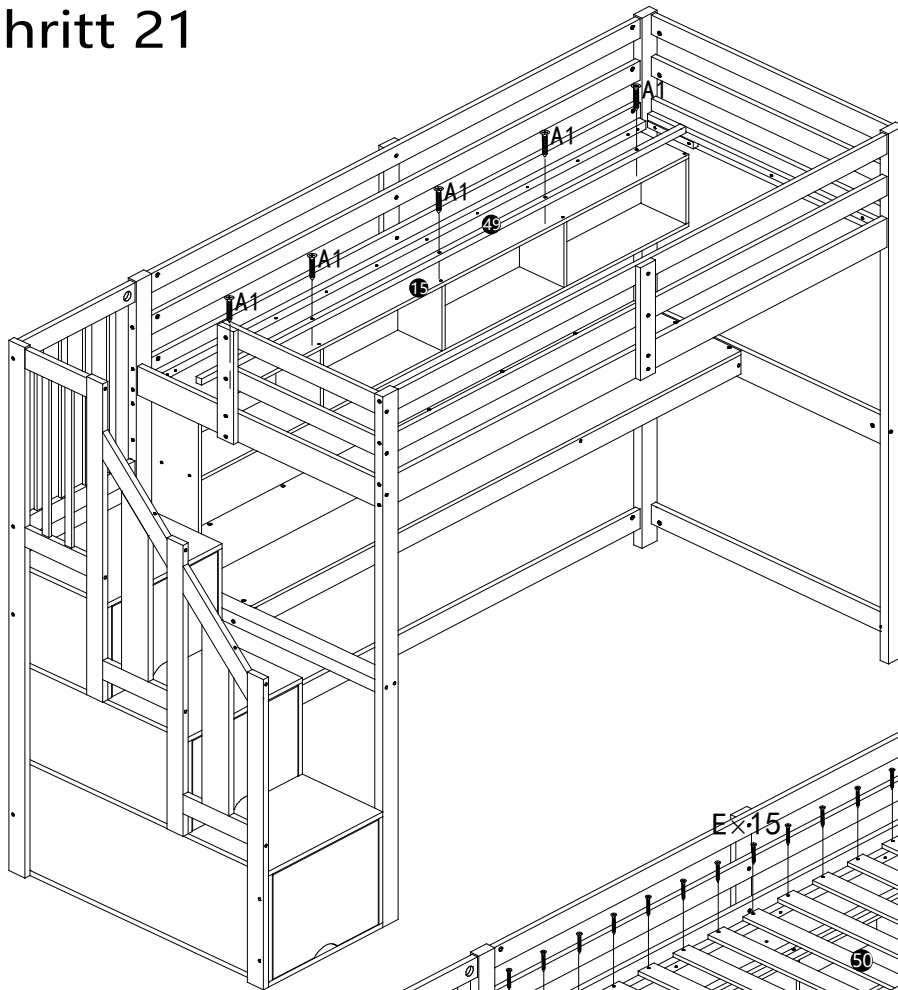

E	Ø0.4x3		30PCS	G		1PC
				A1	Ø0.4x2.5	5PCS

MONTAGEANLEITUNG/ASSEMBLY INSTRUCTIONS

Schritt 22

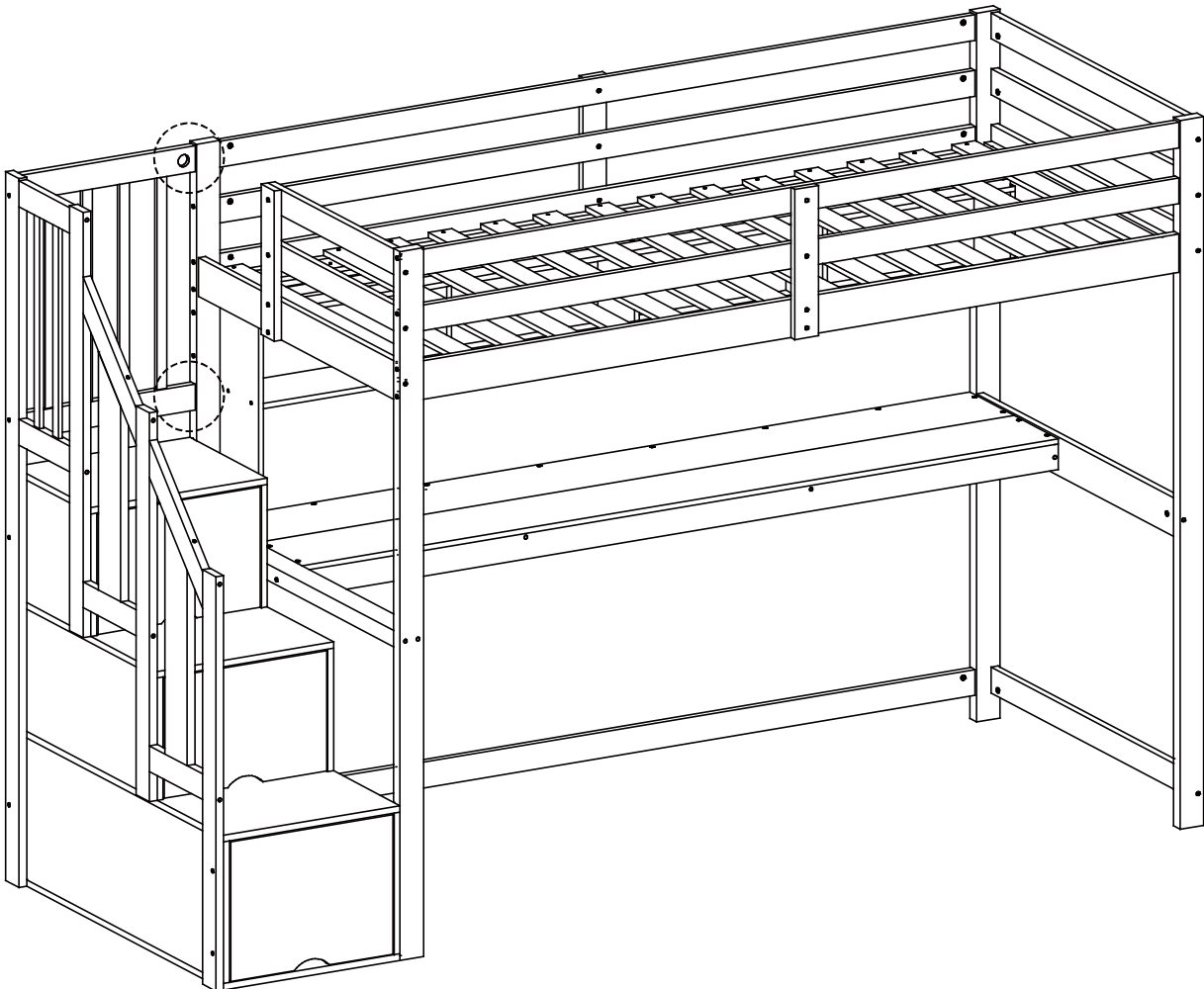
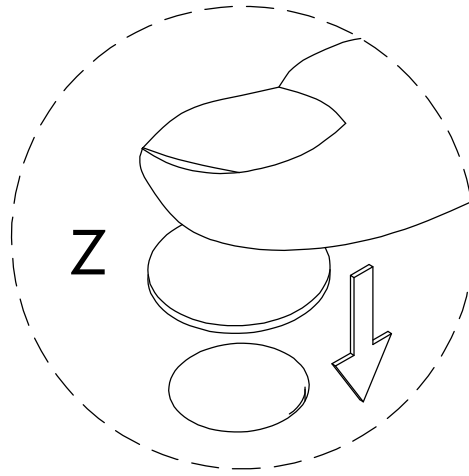
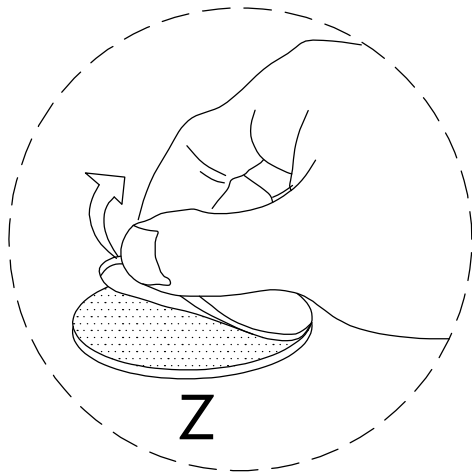

Z



2PCS

MONTAGEANLEITUNG/ASSEMBLY INSTRUCTIONS

Schritt 23

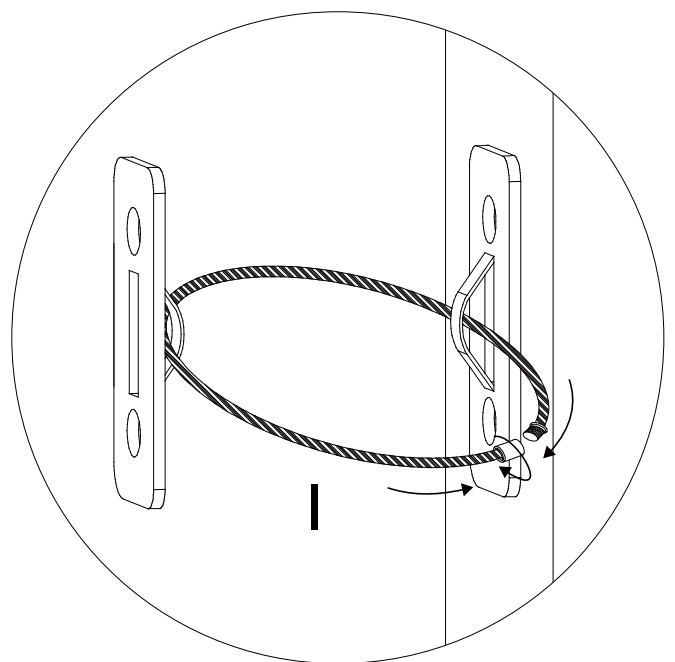
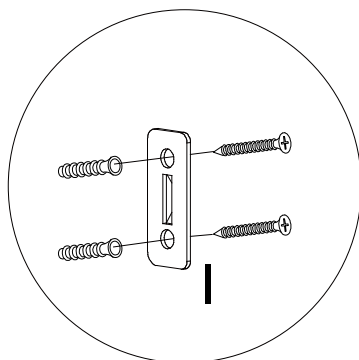
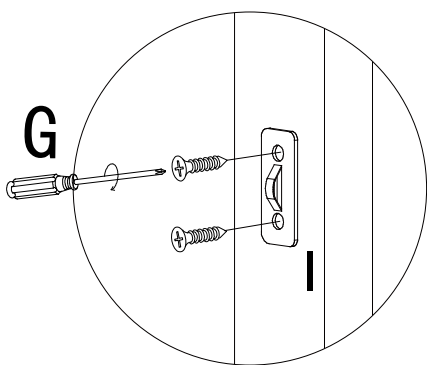
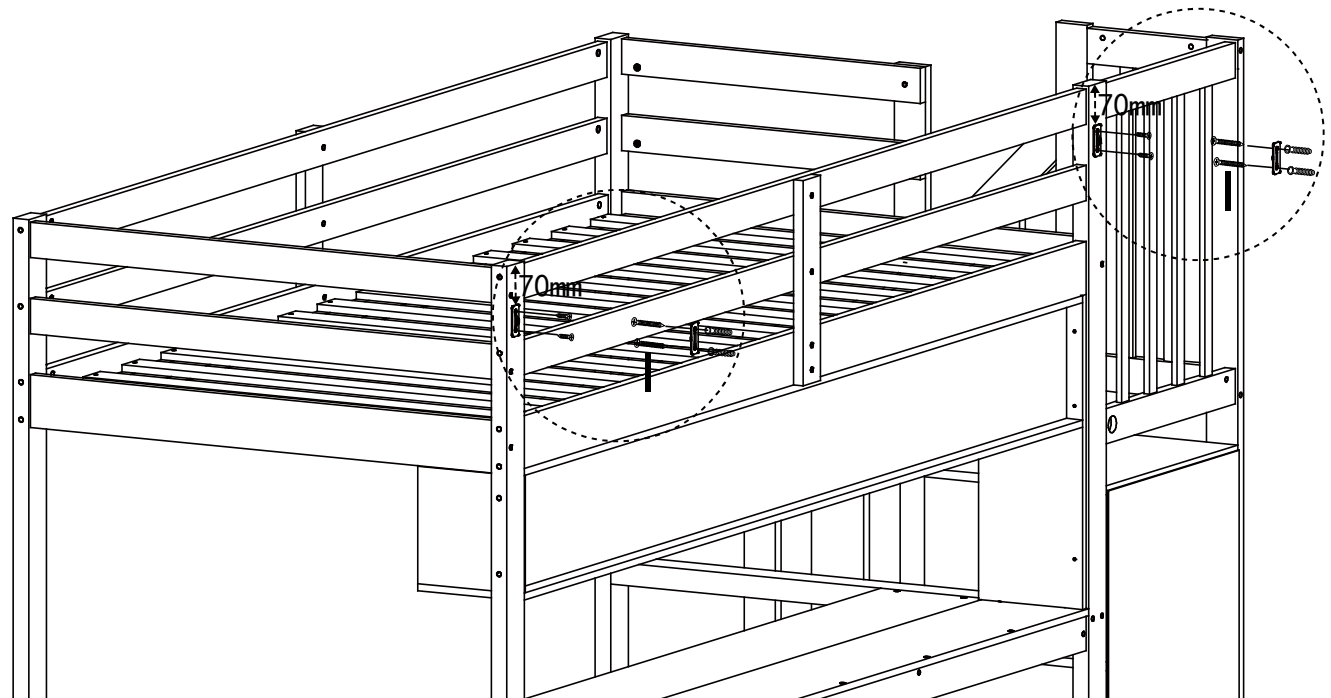

G



1PC

I

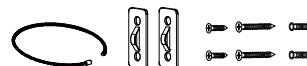

2PCS